

ROTTLER

SG90A CNC CYLINDER HEAD SEAT & GUIDE MACHINE MACHINE INSTALLATION MANUAL

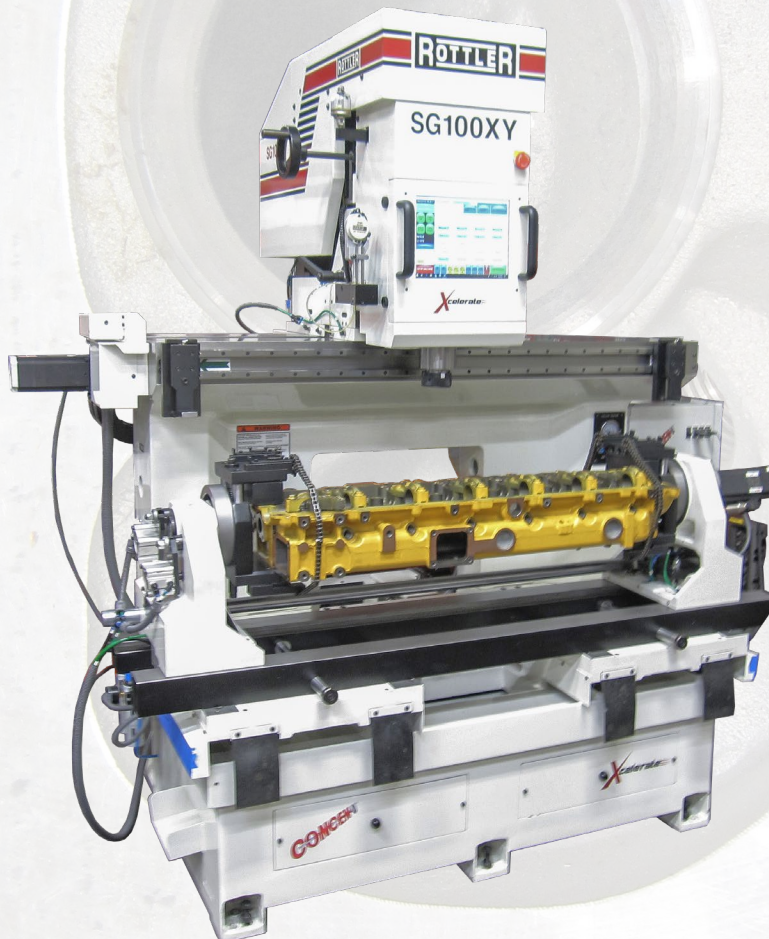

PARTS ORDERING

For optional equipment catalogs, please visit <https://www.rottlermfg.com/documentation.php>

For fastest service ordering parts or equipment, contact us via e-mail with the information below. For customers within the U.S., send emails to parts@rottlermfg.com, for customers outside of the U.S., use intlparts@rottlermfg.com

Have the following information on hand to expedite the ordering process:

1. Your name, business name, and contact number
2. Customer number, or your billing address if you do not have a customer number
3. Shipping address if different from the billing address
4. Machine model and serial number
5. Part number and description of the item(s) to order
6. Preferred method of shipment

For customers outside of the U.S. requiring faster service, contact your local distributor.

In some cases, you may be requested to send a photo of the part you are ordering if it is a replacement part or does not appear in our database.

If you are unsure which part you need to order, contact our service department, and ask to speak to one of our service consultants. They will assist you in determining which part(s) you require.

THERE IS A MINIMUM ORDER OF \$25.00

MANUAL SECTIONS

INTRODUCTION

INSTALLATION

INTRODUCTION

Contents

Introduction	1-2
Description	1-3
Disclaimer	1-3
Limited Warranty	1-4
Online Documentation Access	1-5

Introduction

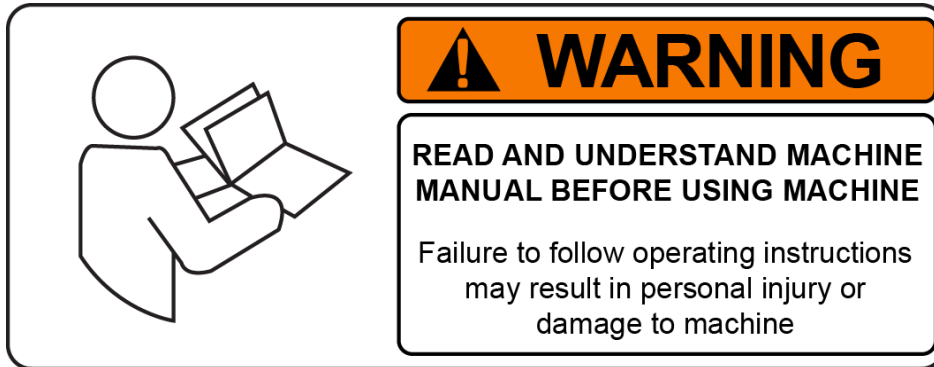

READ THE SAFETY CHAPTER BEFORE INSTALLING MACHINE. THOROUGHLY UNDERSTAND ALL SAFETY ISSUES BEFORE OPERATING MACHINE.

ATTENTION OWNER/BUSINESS MANAGER

To validate the warranty on your new Rottler machine, please be sure to sign and complete the “Installation Report” located in the Installation Chapter of this manual.

We suggest that the new user of the SG90A read the CONTROL DEFINITIONS to get an idea how the machine operates.

The Operating Instructions chapter should be read in order to familiarize the user with the actual button pushing sequences required to carry out a job. These chapters in the manual should be considered an introduction. As the operators of the SG90A series machines gain experience with using the different functions of the machine, complicated setups and programs will make more sense.

The rest of the manual contains information and part number reference on fixtures, cutting tools, and machine maintenance. The operator should read and become familiar with these areas as well.

Description

The Rottler SG90A ACTIV spindle is mounted on a sphere which allows the UNIPILLOT to automatically center with the valve guide centerline while the Workhead is floating on air cushions. Once air floating stops and the Workhead clamps, the UNIPILLOT and valve guide centerline are maintained while cutting the valve seat. ACTIV SPINDLE - Spherical Pneumatic Automatic Alignment System built into the Spindle for fast location of the pilot into the Valve Guide and Accurate Centering (Patent Pending) Air Float Work Head on Intermediate Base Plate Heavy Duty Spindle - Diameter 3.70" (94mm) Hardened and Ground with 10" (250mm) of vertical travel. Rottler Automatic Tightening and Quick Release Spindle Lock Nut System for One Hand Operation for fitting and removing tooling to and from the spindle – never comes loose! Gives Best Concentricity Rottler's Rigid Precision carbide centering UNIPILLOTS are manufactured to less than one tenth (.002mm) tolerance. Combined with the light weight air float Workhead the SG90A gives perfect centering in the valve guide and the best concentricity of any machine on the market.

Disclaimer

The SG90A Manual (henceforth to be referred to as the "Manual") is proprietary to Rottler Manufacturing LLC. ("Rottler Manufacturing") and no ownership rights are hereby transferred. No part of the Manual shall be used, reproduced, translated, converted, adapted, stored in a retrieval system, communicated or transmitted by any means, for any commercial purpose, including without limitation, sale, resale, license, rental or lease, without the prior express written consent of Rottler Manufacturing.

Rottler Manufacturing does not make any representations, warranties or guarantees, express or implied, as to the accuracy or completeness of the Manual. Users must be aware that updates and amendments will be made from time to time to the Manual. It is the user's responsibility to determine whether there have been any such updates or amendments. Neither Rottler Manufacturing nor any of its directors, officers, employees or agents shall not be liable in any manner whatsoever to any person for any loss, damage, injury, liability, cost or expense of any nature, including without limitation incidental, special, direct or consequential damages arising out of or in connection with the use of the Manual.

Rottler Manufacturing and its employees or representatives are not responsible for any information regarding final specifications of any workpiece that is created as a final product when using Rottler equipment. It is the responsibility of the end user of Rottler equipment to determine the final dimensions and finishes of the workpiece that they are working on. Any information regarding final dimensions and finishes that appears in any Rottler literature or that is expressed by anyone representing Rottler is to be regarded as general information to help with the demonstration of or for operator training of Rottler equipment.

Limited Warranty

Rottler Manufacturing Company Model SG90A parts and equipment is warranted as to materials and workmanship. This limited warranty remains in effect for one year from the date of installation or two years from the date of the original shipment from Rottler or whichever date occurs first. This only applies if the machine is owned and operated by the original purchaser and is operated and maintained as per the instructions in the manual. A machine is warranted only if the Installation Report has been properly executed by a certified installation person and received by Rottler at the time of actual installation.

The products are warranted upon delivery to conform to their published specifications and to be free from defects in material and workmanship under normal use for a period of one year from shipment. Should a product not be as warranted, Rottler sole obligation shall be, at its option, to repair, correct or replace the product or to refund the amounts paid for the Product upon its return to a location designated by Rottler. No warranty shall extend to rapid wear Products (including tooling) or to Products which have been subject to misuse (including any use contrary to Rottler instructions), neglect, accident (including during shipment), improper handling or installation, or subject to any modification, repair or service not certified by Rottler. Rottler shall not be liable for any consequential, direct or indirect damages or for any other injury or loss. Buyer waives any right, beyond the foregoing warranty, to make a claim against Rottler. No warranty is provided for any Products not paid in full.

Merchandise cannot be returned to Rottler without prior approval. Customer must contact the Parts Department to get approval and to be issued a Return Goods Authorization number (**RGR#**). Merchandise authorized for return must be returned prepaid. If merchandise is returned with shipping charges collect, the actual amount of these charges may be deducted from any credit which may be due the customer. The **RGR #** assigned by the Parts Department should be written on the shipping label and must appear on a copy of the invoice(s) covering the original shipment. This invoice copy must be included in the box with the parts. Shipment must contain **ONLY** those items on the **RGR** as approved for return. Merchandise must be received within 10 days of the date of **RGR** or the **RGR** will be canceled. All returned merchandise may be subject to a 20% restocking fee on under \$1,000.00 amount or 10% on any items over \$1,000.00. Parts or tooling over 30 days old are considered as customer property and can only be returned with prior approval from Rottler Corporation Management.

The issuance of a **RGR DOES NOT** guarantee credit - it is only authorization for the return of the goods. Credit for return merchandise is at the sole discretion of Rottler. Credit will be issued only after inspection of returned goods.

Tools proven to be defective within the warranty period will be repaired or replaced at the factory's option. We accept no responsibility for defects caused by external damage, wear, abuse, or misuse, nor do we accept any obligation to provide compensation for direct or indirect costs in connection with cases covered by the warranty.

Online Documentation Access

Online documentation for machines and optional equipment can be accessed at the Rottler website. To access documentation open your browser and navigate to <https://www.rottlermfg.com>.

Scroll to the bottom of the page and under the Owner Resources title click the type of documentation you want to access.

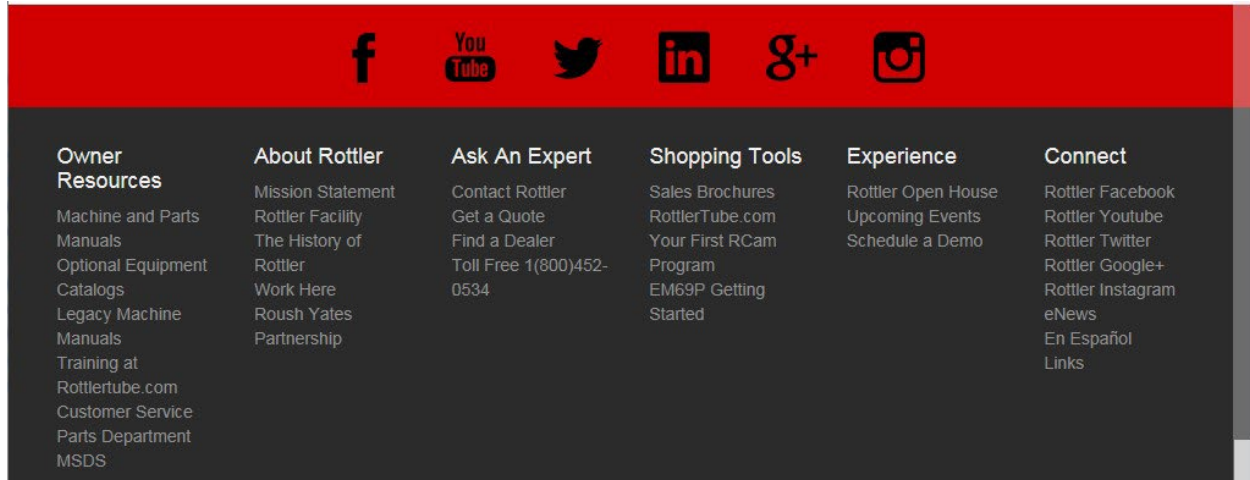

If a log in window pops up asking for user name and password fill in the blanks as shown.

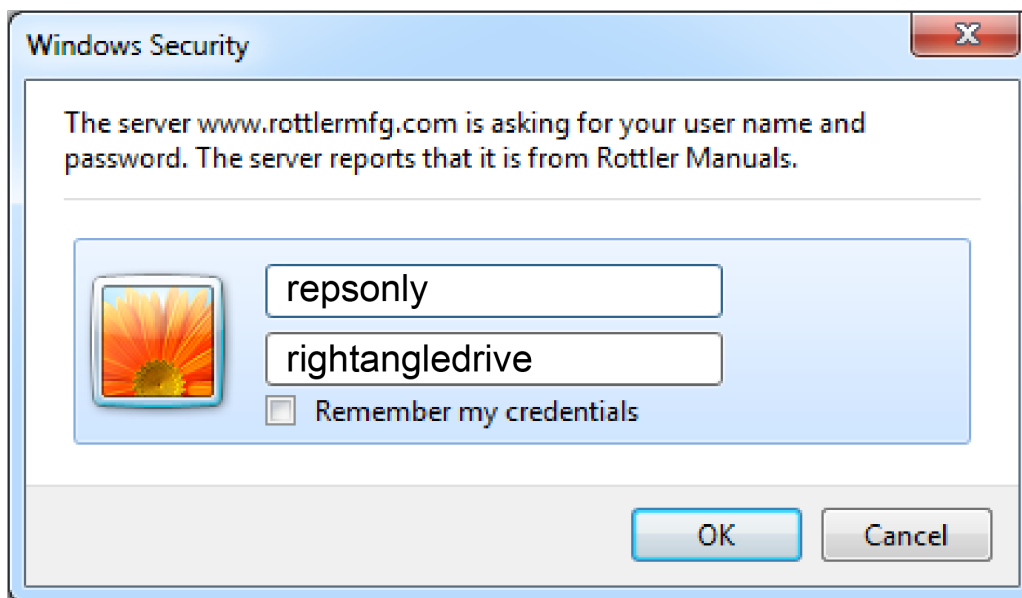

INSTALLATION

Contents

INSTALLATION REPORT	2-3
Installation Procedure	2-7
Unpacking and Lifting	2-7
Removing Shipping Brackets	2-8
Machine & Clearance Dimensions.....	2-9
Preparation for Placement.....	2-11
Positioning the Machine	2-11
Leveling the Machine	2-12
Insert Sharpener Installation.....	2-13
Power and Air Connections	2-15
Air Supply.....	2-15
Air Adjustments	2-16
Float.....	2-16
Power Supply	2-16
Grounding	2-17
Transformer Connections.....	2-18
Creating a Skype Account.....	2-19

ATTENTION OWNER/BUSINESS MANAGER

To validate the warranty on your new Rottler machine, please be sure to sign the installation report after the installation technician has installed the machine and verified the machine is operating correctly and given the operators operation and maintenance training.

Thank you for your cooperation and the opportunity to be of service to you.

ROTTLER MANUFACTURING



INSTALLATION REPORT

SG90A

REV 010924

OFFICE USE ONLY

Route to:

Orders Notified _____ Eng Mgr _____ Svc Mgr _____ Assem Mgr _____ Andy _____ Svc Filing _____

Warranty Exp Date _____

ROTTLER MANUFACTURING MUST HAVE THIS REPORT RETURNED TO PROPERLY QUALIFY WARRANTY ON EQUIPMENT

Customer: _____ Address: _____
 City: _____ State: _____ Zip: _____ Phone: _____
 Country: _____
 Machine Model: _____ Serial Number: _____ Representative: _____

MACHINE INSTALLATION: Electrical information MUST be complete to validate this report.

Customer is responsible for providing electricity to machine in a manner that meets the local electrical code requirements.

- _____ Check machine level for equal support on feet.
- _____ This machine requires between 208 and 240 Volts AC, Single Phase, 50/60 Hz power supply. Measure the incoming voltage between L1 and L2. Current requirements for this machine are 30 amps. Measure the incoming AC voltage at least twice during installation.
 - 1) _____ VAC 2) _____ VAC
- _____ Measure each leg of the incoming supply to ground. When using a one leg and neutral of a 380 VAC three phase supply L1 should measure 240 VAC and Neutral should measure almost 0 VAC. L1 to ground _____ VAC L2 to ground _____ VAC.

Make sure all electrical equipment has the proper overload protection. The SG90A should have a stable power supply to prevent damage and uncontrolled movement of the machine.



Neutral and machine ground are not the same thing. You should measure an open circuit between Neutral and ground.



IF VOLTAGE IS OUTSIDE THE CORRECT RANGE AT ANY TIME THE MACHINE WILL NOT OPERATE PROPERLY AND MAY BE DAMAGED.

- _____ **BEFORE** turning power on to the machine. Check all wires for security by using the correct screw driver and turning CW until movement stops. Stranded wire can “spread” slightly from vibration during transport.
- _____ Install electrical component covers inside the electrical enclosure with fasteners provided.
- _____ Air of the proper pressure and capacity connected to the machine. Air supply must be free from oil and water. Oil or water will damage electrical and air components. Air pressure should never drop below 90 PSI at any time. Failure to provide adequate air supply may cause improper floating and clamping.
- _____ Remove all shipping brackets in accordance with the machine manual.

_____ Clean any rust inhibitor from the machine surfaces. Slide the spindle base from side to side continually cleaning the machine base until all inhibitor is removed.

_____ Have the operator read through the operation manual before training begins. This will help him be familiar with the button pushing sequences. Have the operator read through the manual again after training and some of the sequences will make more sense.

MACHINE START-UP



When starting the machine for the first time, it may move out of control. Make sure all hands are clear of machine parts. Be ready to press the Emergency Stop button if needed.

_____ Turn main power on from the main incoming breaker box.

MACHINE MOVEMENTS

_____ Make sure there is nothing obstructing the full vertical travel of the machine.

_____ When the machine is on the clamp mode and the air pressure is with the requirements, try to move workhead to verify that you have a solid clamp of Work head.

_____ Place the level on the leveling post. The level assembly is referenced to the spindle via the level pin. It is therefore important to check alignment of the pin in reference to the spindle. Even though the level has been carefully calibrated at the factory, it is a good idea to recheck calibration before putting the machine into service. In the event that the level is dropped or handled roughly then the following recalibration methods should be implemented. If calibration is required refer to manual for Calibrating the Digital Level _____ Start the spindle and verify operation.

INSTRUCTING THE OPERATOR:

Note: Rotter employees and representatives per company policy are not permitted to provide end user of Rottler equipment with any OEM specifications for the workpiece that is created by end user using Rottler equipment.



_____ Explain to the customer and operator that at NO time is there to be any software or hardware other than Windows Auto Update and Rottler installed on this machine. This includes screen savers, anti-virus software, and any hardware device that installs software on the machine. Installation of screen savers and anti-virus software can cause dangerous control problems. Any installation of software or hardware will void the warranty on the machine.

_____ Explain to the customer and operator that the machine should be hooked up to the Internet anytime it is on. The software on the machine will automatically connect to our server to send back useful information on machine status.

_____ Connect customer supplied Internet to the machine. Verify that the Internet is accessible from the machine.

_____ Once the machine has been fully setup and is ready for operation create a Skype account for the machine following the instructions in the Installation Section of the manual.

_____ Explain to the customer and the operator how the to log onto Skype and communicate with Rottler when needed.



_____ Computer Viruses will cause the machine control system to become unstable. This may cause the machine to make uncontrolled moves which could create a dangerous environment for the machine operator.

- _____ Explain to the customer the proper way for turn the machine off when it is not in use. Do not leave the machine on overnight. It is important to close all programs followed by shutting down Windows before turning the main power switch off. Do not turn the main power switch off before shutting down Windows.
- _____ Using the operating manual as a guide explain the function of all buttons.
- _____ Cycle all machine movements and supervise the handling of same by operator.
- _____ Demonstrate the engaging of the fine feed system.
- _____ Point out safety features to customer and operator.

Do not push any buttons without thinking of safety first.



Do not assume the Digital level has been calibrated rotate 180 to verify alignment.

- _____ The following is a checklist to go through every time the machine is started to begin machining a seat.

- Work piece secure
- RPM set
- Tool holder adjusted to the correct setting base on the type of seat you will be machining
- Tool holder locked in place
- Floating of the Workhead and clamping

- _____ Proceed to have operator to machine a seat under you control.

_____ **Parts ordering, refer to the operating manual for part numbers and description.**

- _____ Review Emergency stop procedure and with operator per operating manual.

- _____ Explain to the customer the importance of backing up the head profiles to a separate device. Any computer failure or possible operator input error can result in the loss of all head profiles that were created for the machine. Refer to Chapter 5 of the machine manual for detailed instructions on backing up and restoring head profiles.

Installation Procedure

The productivity of this machine will depend a great deal on its proper initial installation, particularly the means by which cylinder heads are lifted into the machine as well as the material handling to and from other operations in your shop.

The proper loading arrangement and location for your SG90A machine is extremely important.

A slow travel (6 to 10 feet / min.) power hoist operated from either a bridge crane or a jib crane arrangement works very well.

Unpacking and Lifting

Carefully uncrate the machine. Remove all tooling from storage compartments and unpack. Locate the leveling bolts and leveling pads. Clean all surfaces with solvent and rags to remove protective shipping coatings.



THIS MACHINE IS TOP-HEAVY. Use care when lifting and moving Machine. Approximate shipping Weight of Machine is 5200 lbs. (2359 kg).

Removing Shipping Brackets

Before leveling the machine, loosen and remove the all shipping brackets and bolts. (Figures 1 – 5)

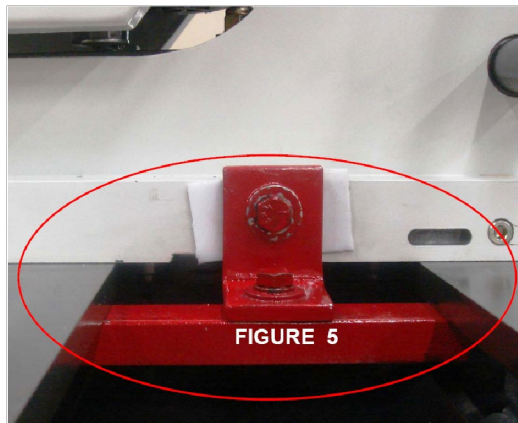
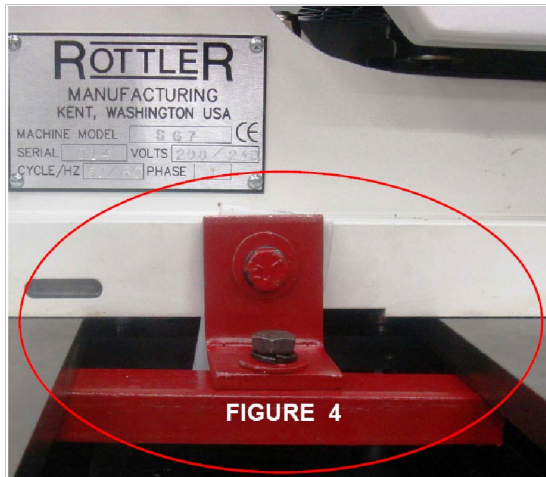
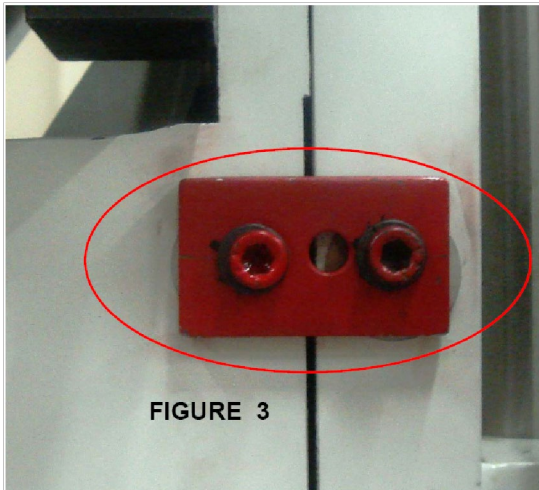
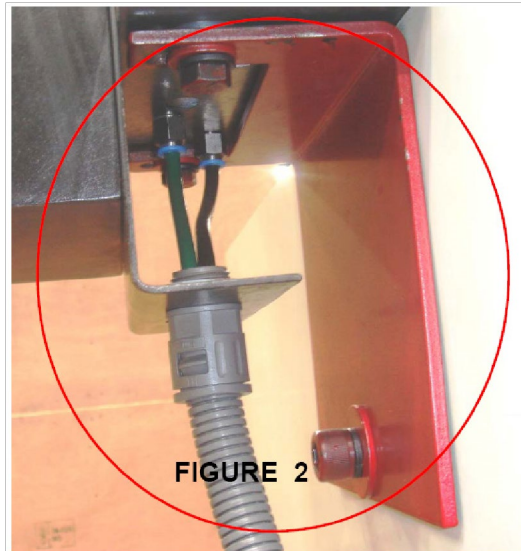
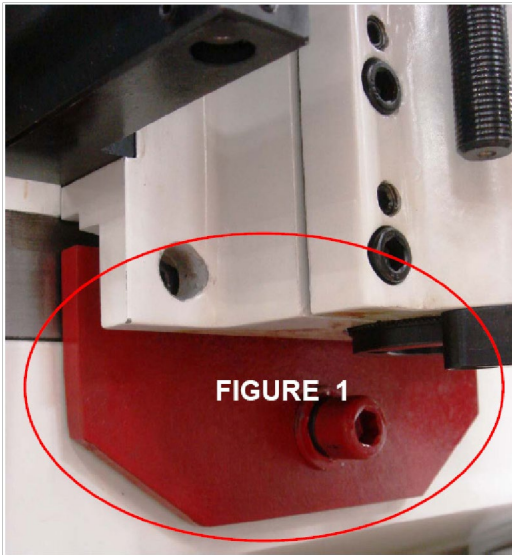

Machine Dimensions

Contact Rottler Sales Department for more information.



Image Currently Unavailable

Machine Clearances

Contact Rottler Sales Department for more information.



Image Currently Unavailable

Preparation for Placement

Air supply is connected at the left side of the machine, at base of lower casting. Connection can either be a quick disconnect or permanent threaded connection. Be certain to use an adequately sized airline, permitting proper operation of float. Air pressure should never drop below 90 PSI at any time. Failure to provide adequate air supply may cause improper floating and clamping.

At this time, some customers will install a T fitting or manifold at the regulator, allowing another air hose to be connected, providing a connection point for air tools. The auxiliary hose, if fitted, should be of sufficient length to easily reach the entire front of the machine.

This machine comes pre-wired and ready to be connected to the power source. The power source should meet all local and national electrical codes. This service should connect to its own circuit breaker or fuse. The machine will require 220 VAC, 30 amp, single-phase power supply.

Positioning the Machine

- Lift Machine using a fork lift. Move fork lift to front of Machine and separate forks so they are visually centered.
- Insert forks under front-center of Machine, using care not to damage Foot Pedals Valve or Air Lines. Tilt forks slightly upward so Machine will lean toward fork lift and lift Machine.
- While Machine is on fork lift, install the 8 leveling bolts. The 2 bolts in the front corners and 2 bolts in the center are for leveling machine.
- The 3 rear bolts and the front center bolt are for support. Just make light contact after machine is leveled.
- Move Machine to desired location and placed leveling bolts over the center hole of the Leveling Pad. Be certain to allow sufficient clearance to allow access for leveling and also for connecting air and electrical lines.
- Lower machine onto leveling pads making certain that the leveling bolts align into counter bore on leveling pads.
- Be certain nothing interferes with air or electrical tracking running from the floating head assembly to the cabinet.
- Determine there is no possibility of air or electrical tracking dragging on wall surfaces or adjacent machinery.
- Wipe top Rails with a clean, dry cloth to remove protective shipping oil.

CAUTION Do not attempt to move the Work Head unless Air Supply is connected, and air valve is turned on and power has been turned on (make sure the EMERGENCY STOP Button is off). From the touch screen, float the workhead, spray, and clean surface with (WD40) or similar degreaser and flow the work Head side by side to remove all the shipping oil from under the work head. (Top Upper surfaces rails should be clean and free of oil).

Leveling the Machine

Use required machinist level. (Starret 98 or better).

NOTE: Rotate Level 180° to check that Level is properly adjusted. If Level does not read same in both directions, recalibrate level.



Use the level on the upper float surface, level the machine as precisely as possible, front to back and side to side.

Adjust 2 front corner and 2 side leveling bolts until level and then extend the front center leveling bolt and 3 rear leveling bolts to support machine. Tighten jam nuts on leveling bolts and recheck level.



Insert Sharpener Installation

All Rottler Seat and Guide machines are supplied with an insert sharpening unit for dressing RCA and RCB inserts. On most machines, the sharpener may be attached to the right-hand side of the machine base. On machines such as the SG100XY model, the sharpener unit may be wired with a standard 220V single phase plug and used as a bench-top unit.

Installation:

Step 1: Install the aluminum mounting plate to the side of the machine

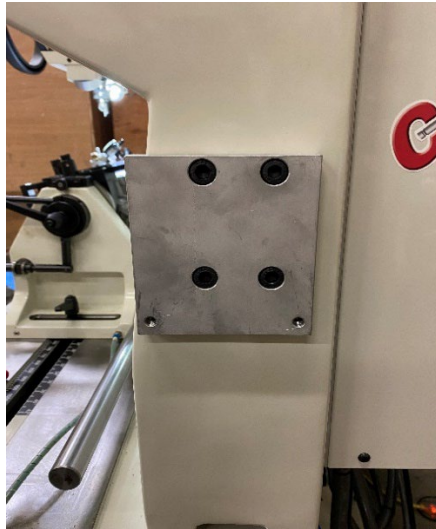

Step 2: Remove the 4 bolts that secure the bottom cover located on the bottom of the sharpener unit



Step 3: Mount the sharpener unit to the machine with the supplied bolts. The shaper mounts using the two holes accessed with the bottom cover removed and mounts to the threaded holes on the previously installed aluminum mounting plate.



Step 4: The sharpener should now be installed on the side of the machine as shown in the figure below:



Step 5: Wire the sharpener by running the power cable through the side of the cabinet and over to the breaker in the electrical cabinet. The sharpener is wired by attaching the red and black power leads to the T1 and T2 terminals on the lower part of the breaker as shown in the figure below. The green and yellow ground cable can be connected to any open ground terminal in the terminal block behind the breaker.

NOTE: POWER MUST BE OFF DURING THIS PROCEDURE AND THE MACHINE SHOULD BE DISCONNECTED FROM ANY POWER SUPPLY!

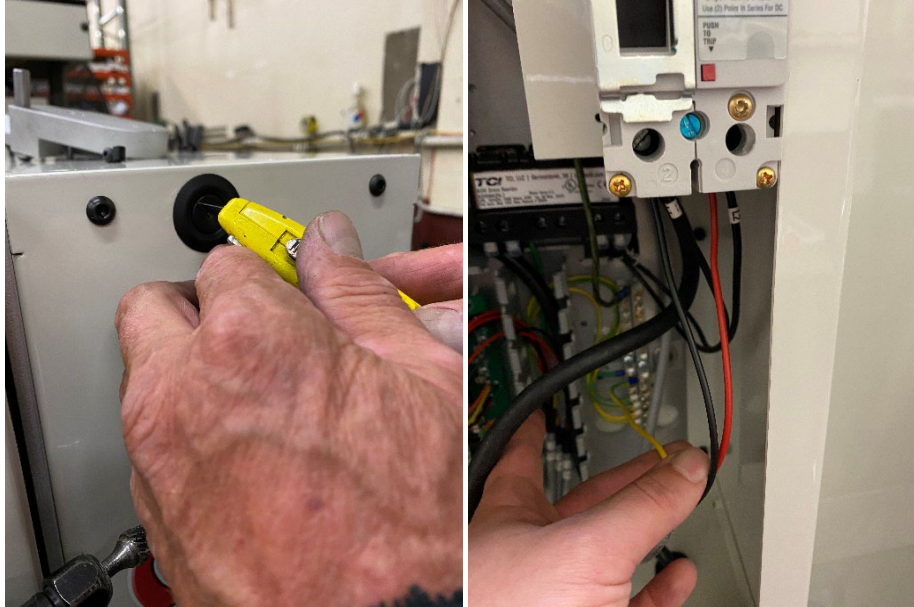

For operation instructions, see the Operations Manual.

Air Supply

It is very important the air source for the SG90A machine be moisture free. Water and oil in the line will result in early cylinder and valve failure. Attach an air source of at least 100 PSI to the water trap and main regulator assembly as shown below.

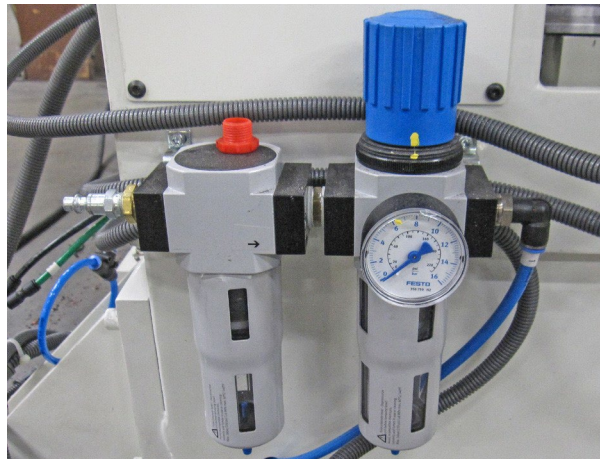

Air Adjustments

Float

The float regulators are located on the right side of machine base. Marked “Work Head Air Float Adjustment” If the work head is not floating properly it could be from too much or too little air from the regulator. Starting with all regulators set at 1 bar with “workhead float” button activated, slowly turn all up .5 bar at a time until workhead start to float. Pushing work head front to rear checking for stiff spots. If workhead is dragging in the forward position, (workhead pulled closest to operator) raise the 2 front regulators 1 mark until it floats without dragging. Same for rear. You may have to go back and forth a few times to get this correct. If workhead is not dragging lower the PSI until it does and then raise 1 notch at a time until it is free. Typically the front two regulators will be slightly higher than the rear two. Once the correct float is established lock the regulators in place by pushing in on the blue adjusting knob.

CAUTION Use as little air as possible to achieve correct floatation. Using too much air will / could cause excessive movement of workhead.



Power Supply

This machine has the following power requirements:

- 208 to 240 VAC
- Single Phase Power
- 50 or 60 Hz
- 30 Amps

See illustration below for correct connection of incoming power. Measured power at the machine's main breaker must be within the required range listed above. If incoming power is not within range, a transformer must be used. Failure to do so will cause the machine to function abnormally and cause permanent damage to the electronic control system.

Some electrical services contain a “Hot Leg, High Leg, or Wild Leg”, where single phase is derived from a three phase connection and one leg measures 208VAC to Ground instead of 120VAC. It is not permitted to use the “Hot Leg” for providing power to this machine. Voltage measured between the phases must be between 208VAC and 240VAC, while each phase to ground must be ~120VAC.

IMPORTANT

Electrically connect in accordance with national and local electrical codes.



CAUTION

Do not attempt to connect more 240VAC to this machine.

Do not attempt to connect to Three Phase Power.

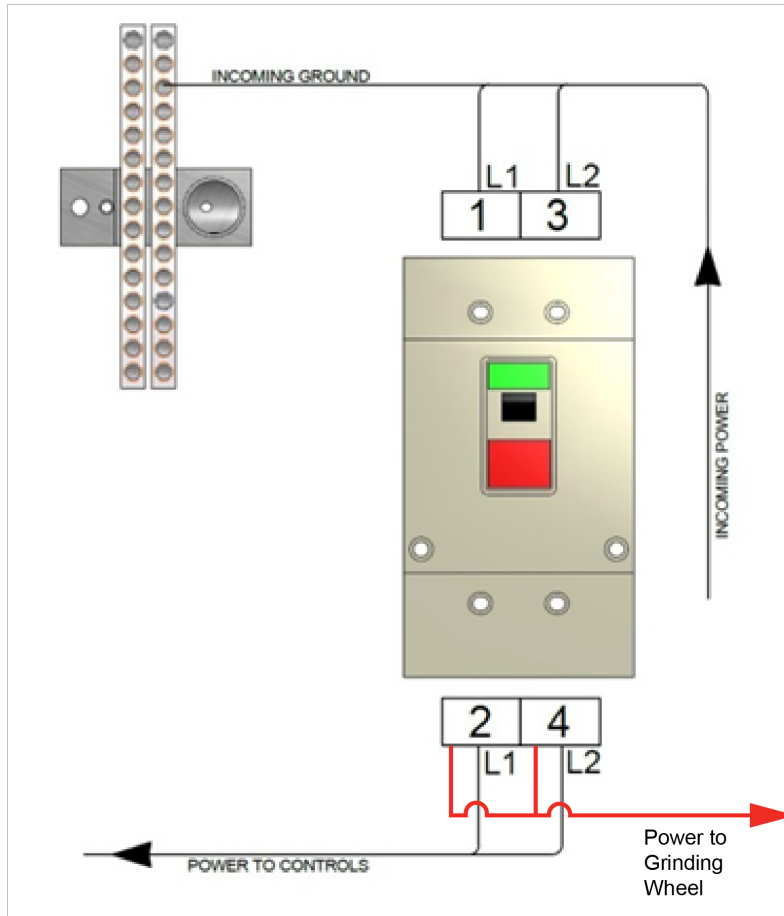

Grounding

The machine requires a good earth ground. The grounding conductor from the incoming power source must be connected to the grounding block located inside of the electrical cabinet. A ground rod installed in addition to the electrical service grounding conductor is permitted, but must be connected directly to the grounding block inside of the electrical cabinet. Connecting the ground rod to the machine base is not permitted. Consult a Licensed Electrician in your area to assess the installation, and install the appropriate ground rod if necessary. Failure to do so may lead to an installation that is unsafe and does not meet national and local electric codes.

Transformer Connections

This machine has the following minimum transformer size requirement:

- 10 kVA

If a transformer is necessary for machine installation, please refer to the diagram below for connection information. Transformers must be sized to meet the minimum power requirements listed above. Consult a Licensed Electrician in your area for transformer selection and installation.

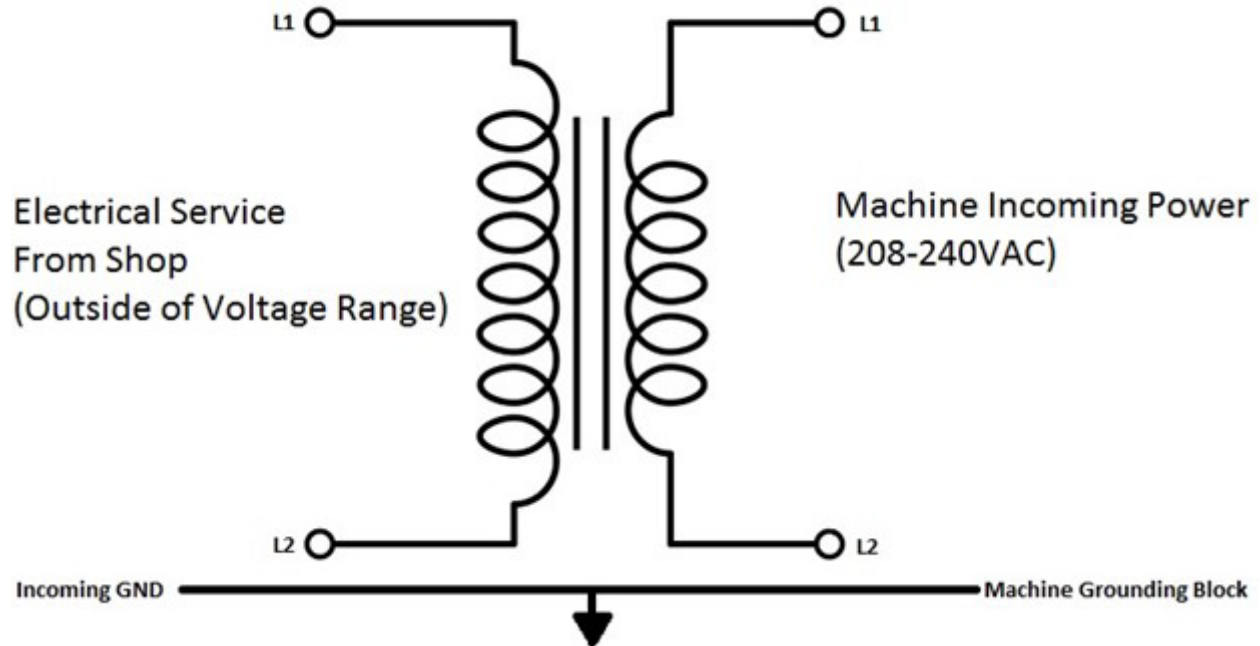

Creating a Skype Account

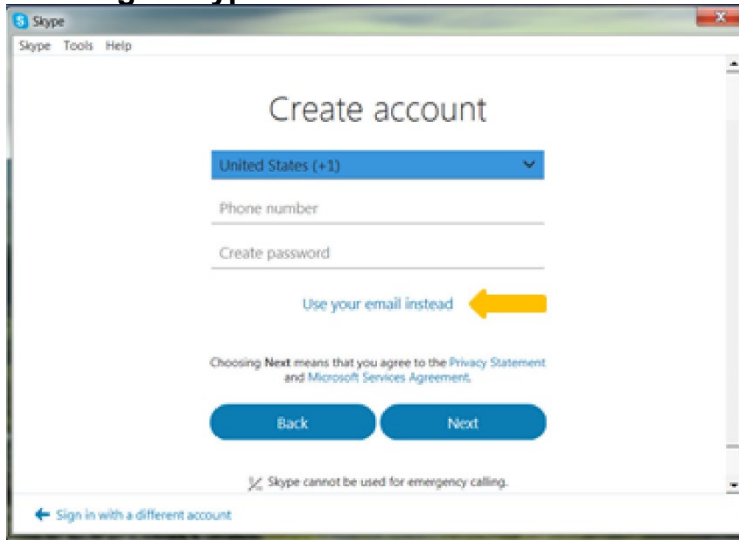

Click on "Create an account"

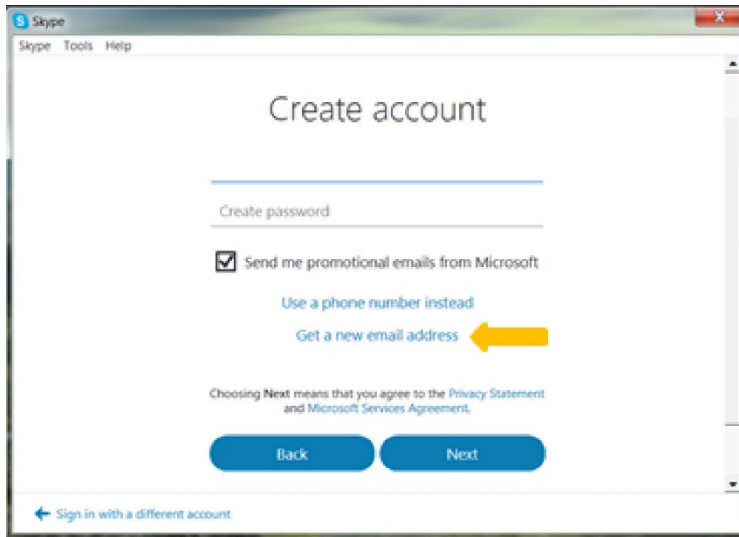

Click on "Use your email instead"

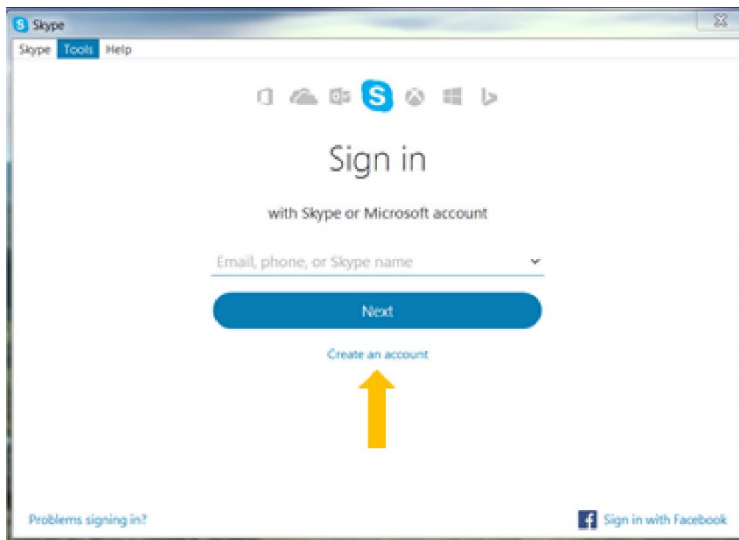

Click on "Get new email address"

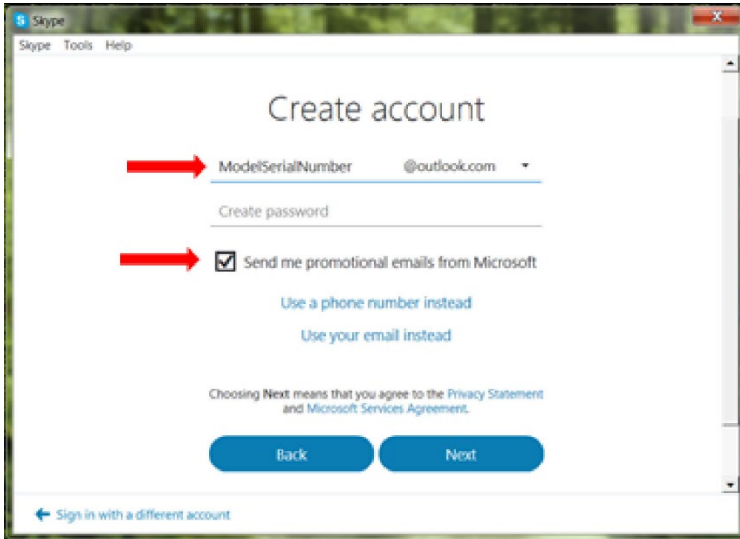

Name the email account using the Rottler machine Model and Serial number.

Ex. H85A111, EM69P001

Create a password that is easy to remember.

Uncheck the box to receive emails from Microsoft.

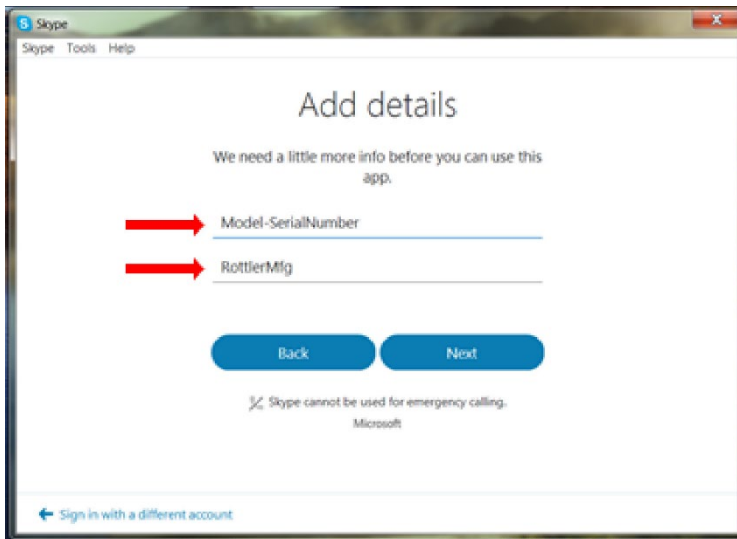

First Name: Model-Serial Number

Ex. EM105-113

Last Name: RottlerMfg

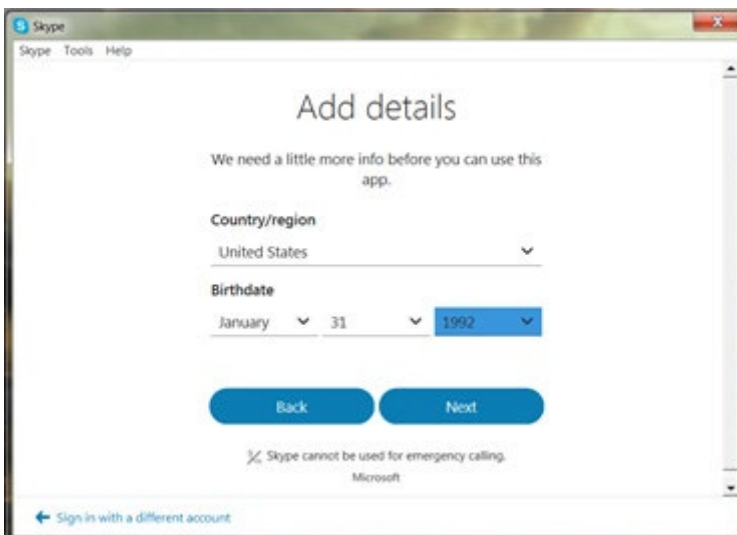

Select your Country/Region

Birthday: Today's Date, 1992