

ROTTLER

F9/10 A MACHINE INSTALLATION MANUAL



PARTS ORDERING

For optional equipment catalogs, please visit <https://www.rottlermfg.com/documentation.php>

For fastest service ordering parts or equipment, contact us via e-mail with the information below. For customers within the U.S., send emails to parts@rottlermfg.com, for customers outside of the U.S., use intlparts@rottlermfg.com

Have the following information on hand to expedite the ordering process:

1. Your name, business name, and contact number
2. Customer number, or your billing address if you do not have a customer number
3. Shipping address if different from the billing address
4. Machine model and serial number
5. Part number and description of the item(s) to order
6. Preferred method of shipment

For customers outside of the U.S. requiring faster service, contact your local distributor.

In some cases, you may be requested to send a photo of the part you are ordering if it is a replacement part or does not appear in our database.

If you are unsure which part you need to order, contact our service department, and ask to speak to one of our service consultants. They will assist you in determining which part(s) you require.

THERE IS A MINIMUM ORDER OF \$25.00

MANUAL SECTIONS

INTRODUCTION

INSTALLATION

INTRODUCTION

Contents

Introduction	1-1
Description	1-2
Disclaimer	1-2
Limited Warranty	1-3
Online Documentation Access	1-4

Introduction

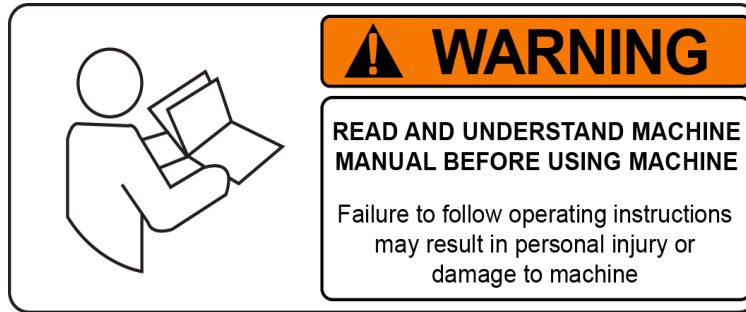

READ THE SAFETY CHAPTER BEFORE INSTALLING MACHINE. THOROUGHLY UNDERSTAND ALL SAFETY ISSUES BEFORE OPERATING MACHINE.

ATTENTION OWNER/BUSINESS MANAGER

To validate the warranty on your new Rottler machine, please be sure to sign and complete the “Installation Report” located in the Installation Chapter of this manual.

We suggest that the new user of the F9A & F10A read the CONTROL DEFINITIONS to get an idea how the F9A & F10A operates.

The Operating Instructions section should be read in order to familiarize the user with the actual button pushing sequences required to carry out a job. These sections in the manual should be considered an introduction. As the operators of the F9A & F10A series gain experience with using the different functions of the F9A & F10A, complicated setups and programs will make more sense.

The rest of the manual contains information and part number reference on fixtures, cutting tools, and F9A & F10A maintenance. The operator should read and become familiar with these areas as well.

Description

The model F9A & F10A is a precision, single point high-speed boring unit. The F9A & F10A can be equipped with tooling and accessories for re-boring most American passenger car and truck engines, In-lines, as well as 90 and 60 degree V-types.

F9A & F10As can be easily tooled, to a wide range of engines, including European and Asian engines, also, the F9A & F10A can be easily adapted to perform other boring operations.

The F9A & F10A is designed, to maintain alignment of cylinder bores to the pan rails and main bearing bore locations, as was done in the original factory machining. This overcomes the many inaccuracies and out-of-alignment problems associated with clamping portable boring bars to the cylinder head surface of blocks.

Convenient controls, fast block clamping, precise positioning and clamping, means considerable savings in floor to floor time, and operator involvement.

Change over or resetting time required to set up V-type or in-line engines is a minimum, making this F9A & F10A highly suited to the jobber shop where engines cannot be run through in model lots.

Disclaimer

The F9A & F10A Manual (henceforth to be referred to as the "Manual") is proprietary to Rottler Manufacturing LLC. ("Rottler Manufacturing") and no ownership rights are hereby transferred. No part of the Manual shall be used, reproduced, translated, converted, adapted, stored in a retrieval system, communicated or transmitted by any means, for any commercial purpose, including without limitation, sale, resale, license, rental or lease, without the prior express written consent of Rottler Manufacturing.

Rottler Manufacturing does not make any representations, warranties or guarantees, express or implied, as to the accuracy or completeness of the Manual. Users must be aware that updates and amendments will be made from time to time to the Manual. It is the user's responsibility to determine whether there have been any such updates or amendments. Neither Rottler Manufacturing nor any of its directors, officers, employees or agents shall not be liable in any manner whatsoever to any person for any loss, damage, injury, liability, cost or expense of any nature, including without limitation incidental, special, direct or consequential damages arising out of or in connection with the use of the Manual.

Rottler Manufacturing and its employees or representatives are not responsible for any information regarding final specifications of any workpiece that is created as a final product when using Rottler equipment. It is the responsibility of the end user of Rottler equipment to determine the final dimensions and finishes of the workpiece that they are working on. Any information regarding final dimensions and finishes that appears in any Rottler literature or that is expressed by anyone representing Rottler is to be regarded as general information to help with the demonstration of or for operator training of Rottler equipment.

Limited Warranty

Rottler Manufacturing Company Model F9A & F10A parts and equipment is warranted as to materials and workmanship. This limited warranty remains in effect for one year from the date of installation or two years from the date of the original shipment from Rottler or whichever date occurs first. This only applies if the machine is owned and operated by the original purchaser and is operated and maintained as per the instructions in the manual. A machine is warranted only if the Installation Report has been properly executed by a certified installation person and received by Rottler at the time of actual installation.

The products are warranted upon delivery to conform to their published specifications and to be free from defects in material and workmanship under normal use for a period of one year from shipment. Should a product not be as warranted, Rottler sole obligation shall be, at its option, to repair, correct or replace the product or to refund the amounts paid for the Product upon its return to a location designated by Rottler. No warranty shall extend to rapid wear Products (including tooling) or to Products which have been subject to misuse (including any use contrary to Rottler instructions), neglect, accident (including during shipment), improper handling or installation, or subject to any modification, repair or service not certified by Rottler. Rottler shall not be liable for any consequential, direct or indirect damages or for any other injury or loss. Buyer waives any right, beyond the foregoing warranty, to make a claim against Rottler. No warranty is provided for any Products not paid in full.

Merchandise cannot be returned to Rottler without prior approval. Customer must contact the Parts Department to get approval and to be issued a Return Goods Authorization number (**RGR#**). Merchandise authorized for return must be returned prepaid. If merchandise is returned with shipping charges collect, the actual amount of these charges may be deducted from any credit which may be due the customer. The **RGR #** assigned by the Parts Department should be written on the shipping label and must appear on a copy of the invoice(s) covering the original shipment. This invoice copy must be included in the box with the parts. Shipment must contain **ONLY** those items on the **RGR** as approved for return. Merchandise must be received within 10 days of the date of **RGR** or the **RGR** will be canceled. All returned merchandise may be subject to a 20% restocking fee on under \$1,000.00 amount or 10% on any items over \$1,000.00. Parts or tooling over 30 days old are considered as customer property and can only be returned with prior approval from Rottler Corporation Management.

The issuance of a **RGR DOES NOT** guarantee credit - it is only authorization for the return of the goods. Credit for return merchandise is at the sole discretion of Rottler. Credit will be issued only after inspection of returned goods.

Tools proven to be defective within the warranty period will be repaired or replaced at the factory's option. We accept no responsibility for defects caused by external damage, wear, abuse, or misuse, nor do we accept any obligation to provide compensation for direct or indirect costs in connection with cases covered by the warranty.

Online Documentation Access

Online documentation for machines and optional equipment can be accessed at the Rottler website. To access documentation open your browser and navigate to <https://www.rottlermfg.com>.

Scroll to the bottom of the page and under the Owner Resources title click the type of documentation you want to access.

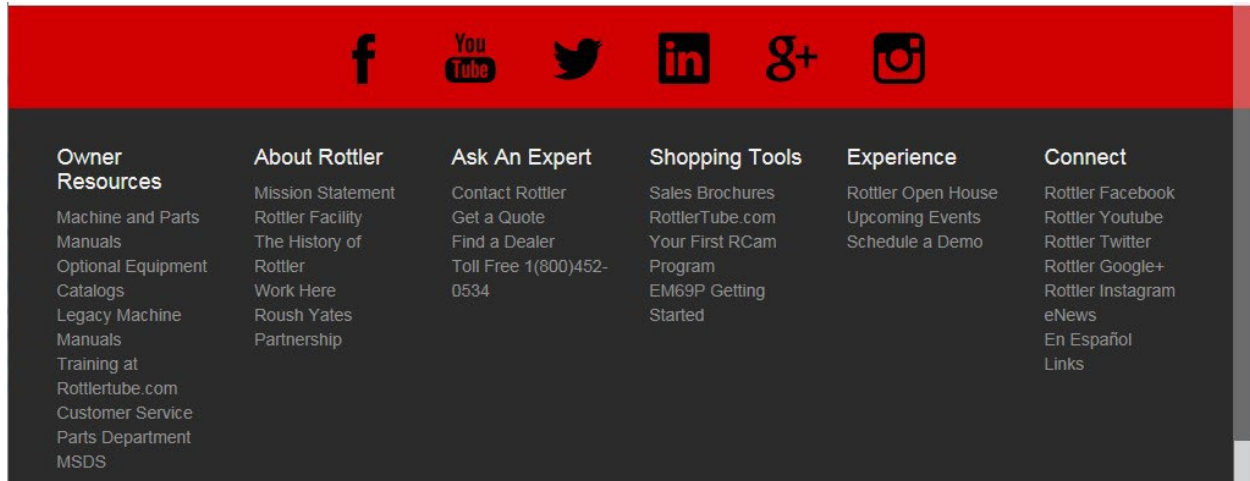

If a log in window pops up asking for user name and password fill in the blanks as shown.

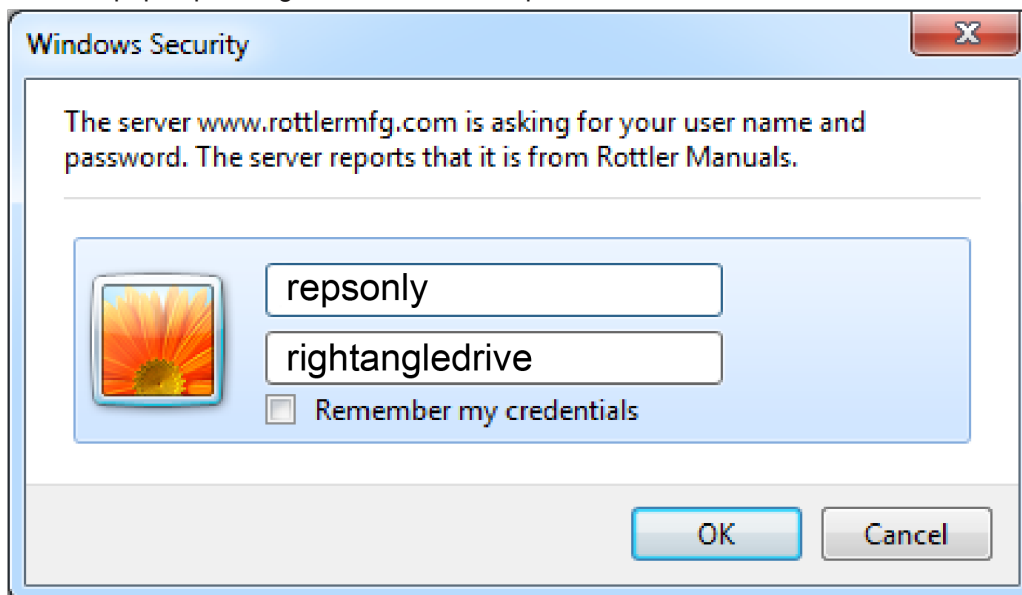

INSTALLATION

Contents

INSTALLATION REPORT	2-2
Installation Procedure	2-8
Machine Installation	2-8
Location	2-8
Unpacking	2-8
Shipping and Hold Down	2-8
Leveling	2-8
Air Supply	2-9
Power Supply	2-10
Grounding	2-11
Transformer Connections.....	2-11
Creating a Skype Account	2-12

ATTENTION OWNER/BUSINESS MANAGER

To validate the warranty on your new Rottler machine, please be sure to sign the installation report after the installation technician has installed the machine and verified the machine is operating correctly and given the operators operation and maintenance training.

Thank you for your cooperation and the opportunity to be of service to you.

ROTTLER MANUFACTURING



INSTALLATION REPORT

F9A / F10A

REV 010924

OFFICE USE ONLY

Route to:

Orders Notified _____ Eng Mgr _____ Srvc Mgr _____ Assem Mgr _____ Andy _____ Srvc Filing _____

Warranty Exp Date _____

ROTTLER MANUFACTURING MUST HAVE THIS REPORT RETURNED TO PROPERLY QUALIFY WARRANTY ON EQUIPMENT

Customer: _____ Address: _____

City: _____ State: _____ Zip: _____ Phone: _____

Country: _____

Machine Model: _____ Serial Number: _____ Representative: _____

MACHINE INSTALLATION: Electrical information MUST be complete to validate this report.



VERY IMPORTANT: Modern design machines contain electronic low voltage circuitry that provides great advantages and a better machine life. **BUT**, you must have an excellent, stable power supply along with a good earth ground. If not, electrical noise problems are likely to interfere with machine operation unexpectedly.

Customer is responsible for providing electricity to machine in a manner that meets the local electrical code requirements.

_____ **BEFORE** turning power on to the machine. Check all wires for security by using the correct screw driver and turning CW until movement stops. Stranded wire can “spread” slightly from vibration during transport.

_____ Install electrical component covers inside the electrical enclosure with fasteners provided.

_____ Check machine level for equal support on feet.

_____ This machine requires between 208 and 240 Volts AC, Single Phase, 50/60 Hz power supply.

Measure the incoming voltage between L1 and L2. Current requirements for this machine are 30 amps. Measure the incoming AC voltage at least twice during installation.

1) _____ VAC 2) _____ VAC

_____ Measure each leg of the incoming supply to ground. When using a one leg and neutral of a 380 VAC three phase supply L1 should measure 240 VAC and Neutral should measure almost 0 VAC.

L1 to ground _____ VAC L2 to ground _____ VAC.



Neutral and machine ground are not the same thing. You should measure an open circuit between Neutral and ground.



IF VOLTAGE IS OUTSIDE THE CORRECT RANGE AT ANY TIME THE MACHINE WILL NOT OPERATE PROPERLY AND MAY BE DAMAGED.

_____ Air of the proper pressure and capacity connected to the machine. Air supply must be free from oil and water. Oil or water will damage electrical and air components. A of at least 80 PSI will use 1 cu. Ft./min. Maximum.

- _____ Each main system is protected internally by circuit breakers. Green the breaker is “tripped” and red indicates the breaker is “Hot” (conducting electricity).
- _____ Loosen the shipping bolt and adjust in accordance with the machine manual.
- _____ Clean any rust inhibitor from the machine surfaces. Slide the spindle base from side to side continually cleaning the machine base until all inhibitor is removed.
- _____ Have the operator read through the operation manual before training begins. This will help him be familiar with the button pushing sequences. Have the operator read through the manual again after training and some of the sequences will make more sense.

MACHINE START-UP



CAUTION When starting the machine for the first time, it may move out of control. Make sure all hands are clear of machine parts. Be ready to press the Emergency Stop button if needed.

- _____ Turn main power on at the main disconnect switch located on the rear enclosure.
- _____ If any of the circuit breakers “trip”, reset and call factory for possible trouble shooting.

MACHINE MOVEMENTS

- _____ Make sure there is nothing obstructing the full vertical travel of the machine.
- _____ Perform the Inner and Outer spindle adjustments per the instructions in the manual.
NOTE: These adjustments must be performed at machine start-up or the travel and accuracy of the machine will be off.
- _____ Put the machine in hand wheel mode and verify operation. Put an indicator on the cutter head and verify .001” movement per detent in course mode and .0001” in fine mode. If the indicator is jumpy the outer spindle adjustment may be too tight. Refer to manual and re-adjust.
- _____ Use the rapid buttons and verify proper vertical travel.
- _____ Start spindle and verify proper operation in all speeds.
- _____ Move the machine to its vertical limits and verify Home and down limit operation.
- _____ Check the spindle sweep of the machine. It should be within .0005”

INSTRUCTING THE OPERATOR:



WARNING *Note: Rottler employees and representatives per company policy are not permitted to provide end user of Rottler equipment with any OEM specifications for the workpiece that is created by end user using Rottler equipment.*

- _____ Explain to the customer and operator that at NO time is there to be any software or hardware other than Windows Auto Update and Rottler installed on this machine. This includes screen savers, anti-virus software, and any hardware device that installs software on the machine. Installation of screen savers and anti-virus software can cause dangerous control problems. Any installation of software or hardware will void the warranty on the machine.
- _____ Explain to the customer and operator that the machine should be hooked up to the Internet anytime it is on. The software on the machine will automatically connect to our server to send back useful information on machine status.
- _____ Connect customer supplied Internet to the machine. Verify that the Internet is accessible from the machine.
- _____ Once the machine has been fully setup and is ready for operation create a Skype account for the machine following the instructions in the Installation Section of the manual.
- _____ Explain to the customer and the operator how the to log onto Skype and communicate with Rottler when needed.

! WARNING Computer Viruses will cause the machine control system to become unstable. This may cause the machine to make uncontrolled moves which could create a dangerous environment for the machine operator.

IMPORTANT Refer to Chapter 4, Control Definitions of the Machine Manual, Section: Computer and Controller System Safety. Explain and discuss this section carefully with Owner/Manager/Operator and have them sign off. Failure to do so will result in the machine warranty being Null and Void.

Signature / Title

- _____ Explain to the customer the importance of backing up the block profiles to a separate device. Any computer failure or possible operator input error can result in the loss of all block profiles that were created for the machine. Refer to Chapter 5 of the machine manual for detailed instructions on backing up and restoring block profiles.
- _____ Using the operating manual as a guide explain the function of all buttons.
- _____ Cycle all machine movements and supervise the handling of same by operator.
- _____ Demonstrate the differences of Manual and Auto operation.
- _____ Verify .0035" tilt of spindle base when auto retracting.
- _____ Fully explain the entire Auto Cycle from Centering to Auto Retract.
- _____ Explain machine parameters and error messages. It is very important that the customer does not change parameter settings without first checking with Rottler Manufacturing. If certain parameters are changed the machine may make uncontrolled move or not operate at all.
- _____ Point out safety features to customer and operator. Do not push any buttons without thinking of safety first.
- _____ Have operator sharpen a tool bit (remove handle) if a sharpener has been supplied.

! CAUTION Do not assume the cutterhead micrometer has been calibrated.

- _____ The following is a checklist to go through every time the machine is started to begin a cut or automatic cycle.
 - Work piece secure
 - RPM set
 - Feed Rate set
 - Correct program in use
 - Program oriented correctly (vertical zero at correct place)
 - Centering range adequate
 - Guards in place
 - Cutterhead secure
 - Tool holder adjusted to the correct size
 - Tool holder locked in place
- _____ Proceed to have operator bore block to size.
- _____ (V6/8 Fixture) Demonstrate V fixture use on 60 and 90 degree blocks. Explain the necessity of carefully checking that no bearing cap or extensions interfere with the accurate seating of pan rails and main bearing bar. Work out the best block handling system with the operator. Fully explain main bearing index method from figures in the manual and the locator bar twist during bank switch required on all new 502-1-72F fixtures. The UP mark must always be visible. **Stress caution and personal safety.**
- _____ Thoroughly explain V6/8 fixture safety requirements of main bearing caps or dummy caps on V blocks.

- _____ Demonstrate and explain boring with the electronic hand wheel.
- _____ Fully demonstrate full and partial clamp force use.
- _____ Explain the correct Feed rates and speeds for carbide, R4, R2 coated tools and sleeve cuts.
- _____ Cutter head change and expected stub bar performance.

Parts ordering, refer to the operating manual for part numbers and description.

- _____ Offset tool bits, calibration of micrometer and anvil setting.
- _____ Review Emergency stop procedure with operator per operating manual.

MAINTENANCE SECTION

- _____ Use the manual as a reference when explaining routine maintenance and lubrication.
- _____ Overload devices, There are no mechanical overload devices on this machine. The machine is protected from overload by the motor controllers. If the system is overloaded the controllers shut the motors off. The controllers can be reset by turning the main power off for at least 1 minute, then turning it back on.
- _____ Explain again the proper Inner and Outer spindle adjustment to the operator.
- _____ Air float adjustment.
- _____ Dampener cleaning.
- _____ Centering and finger changing.
- _____ Micrometer and anvil thread adjustment.
- _____ Diamond wheel dressing.
- _____ Inspection of tool bit hole in tool holders (deformation due to accidental impact).

Rottler Manufacturing and its employees or representatives are not responsible for any information regarding final specifications of any workpiece that is created as a final product when using Rottler equipment. It is the responsibility of the end user of Rottler equipment to determine the final dimensions and finishes of the workpiece that they are working on. Any information regarding final dimensions and finishes that appears in any Rottler literature or that is expressed by anyone representing Rottler is to be regarded as general information to help with the demonstration of or for operator training of Rottler equipment.

Note: Rotter employees and representatives per company policy are not permitted to provide end user of Rottler equipment with any OEM specifications for the workpiece that is created by end user using Rottler equipment.

General remarks on machine performance, adjustments as received and any further organization or parts required to complete the installation.

Instructions given to: _____

Sales/Service Technician: _____ Date _____

Shop Foreman/Superintendent or Owner: _____ Date _____

Once completed e-mail this form to:

service@rottlermfg.com

Installation Procedure

Machine Installation

Location

The productivity of the F9/10A will depend a great deal on the proper initial installation. Pay particular attention to the means by which work pieces are lifted into and out of the machine as well as the material handling to and from other operations in your shop. The proper loading arrangements and work location for your F9/10A is extremely important.

A slow travel (6' to 10' per minute) power hoist, operated from either a bridge or jib crane arrangement works very well. A 1000 lb. Is generally adequate for lifting most engine blocks. An air hoist with speed control makes an ideal method for fast, efficient loading and unloading.

For shops where large production runs are anticipated, the work pieces should be loaded and unloaded directly from a conveyor. If this is not the case, we suggest you pay considerable attention to the crane so that it covers an adequate area to allow the operator to back up and remove work pieces without creating a cluttered, dangerous work area.

Unpacking

Use care when removing the crate materials from the machine. Be careful not to use force on any part of the machine.

Remove the Toolbox, Parallels and optional equipment from the machine. Completely clean these articles along with the rest of the machine with solvent, rust inhibitor was applied at the time of shipment. Any of the rust inhibitor left on the machine will allow Cast Iron dust to build up and cause premature wear to the machine.

Shipping and Hold Down

Remove the sheet metal cover from the rear of the Spindle Base by removing the four (4) round head Allen screws.

Pull out the Cotter Key from the Castle nut located in the center of the Spindle Base and loosen the nut. Turn the machine on and place it in Neutral. Hand tighten the nut to take out all the play in the Roller Key assembly. Loosen the nut approximately 1/12 of a turn. Place the Cotter Key in the nearest slot of the Castle Nut. Put the machine in Float and move the machine from side to side and remove the rust inhibitor that was placed under the Spindle Base. This may have to be done several time to remove all of the rust inhibitor.

Switch the machine to Clamp and check for proper operation of the clamp assembly. Check for proper release and movement when put back into Float.

Note: Clamp cylinder rods should move a minimum of 5/8" when Spindle Base is clamped.

Leveling

Four square head bolts (504-1-12A), four jam nuts (502-1-12F), and four chamfered washers (502-1-12) are provided with the machine for leveling. Screw the jam nuts all the way onto the bolts, insert the bolts at the base support points (corners). Screw the bolts in until they are just protruding from the bottom of the base casting. Lower the machine onto the washers, making sure the bolts seat into the chamfered area of the washers.

Using a precision level, level the upper table within .003" per foot in both directions. Make sure that the machine weight is equally supported at all four support points.

Air Supply

It is very important that the air source for the F9/10A be moisture free. Water and oil in the air lines will result in early cylinder and valve failure as well as introducing moisture into the Inner spindle bearings. ***The factory recommends installing a water trap at the machine.***

Attach a 100 PSI. air source to the main air intake located on the right hand side of the main rear enclosure.

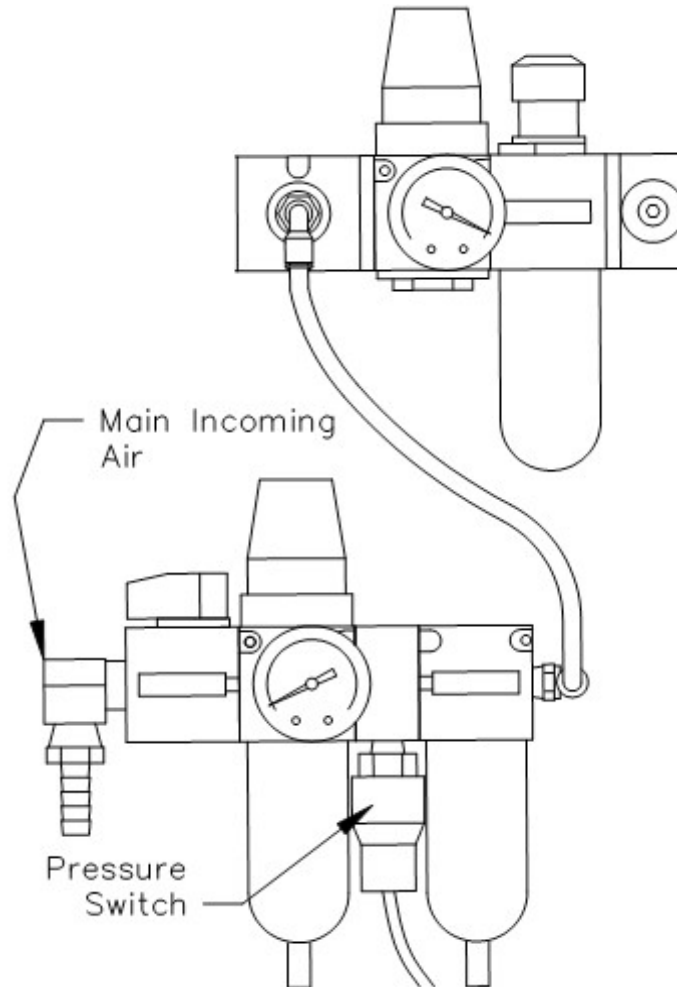

Power Supply

This machine has the following power requirements:

- 208 to 240 VAC
 - Single Phase Power
 - 50 or 60 Hz
 - 30 Amps
- See illustration below for correct connection of incoming power. Measured power at the machine's main breaker must be within the required range listed above. If incoming power is not within range, a transformer must be used. Failure to do so will cause the machine to function abnormally and cause permanent damage to the electronic control system.
 - Some electrical services contain a "Hot Leg, High Leg, or Wild Leg", where one leg measures 208VAC to Ground instead of 120VAC. Use of the "Hot Leg, High Leg, or Wild Leg" is NOT permitted on this machine. If a "Hot Leg, High Leg, or Wild Leg" is present, connect the machine in the Single Phase configuration shown below.

IMPORTANT

- **Electrically connect in accordance with national and local electrical codes.**



CAUTION

Do not attempt to connect more 240VAC to this machine.

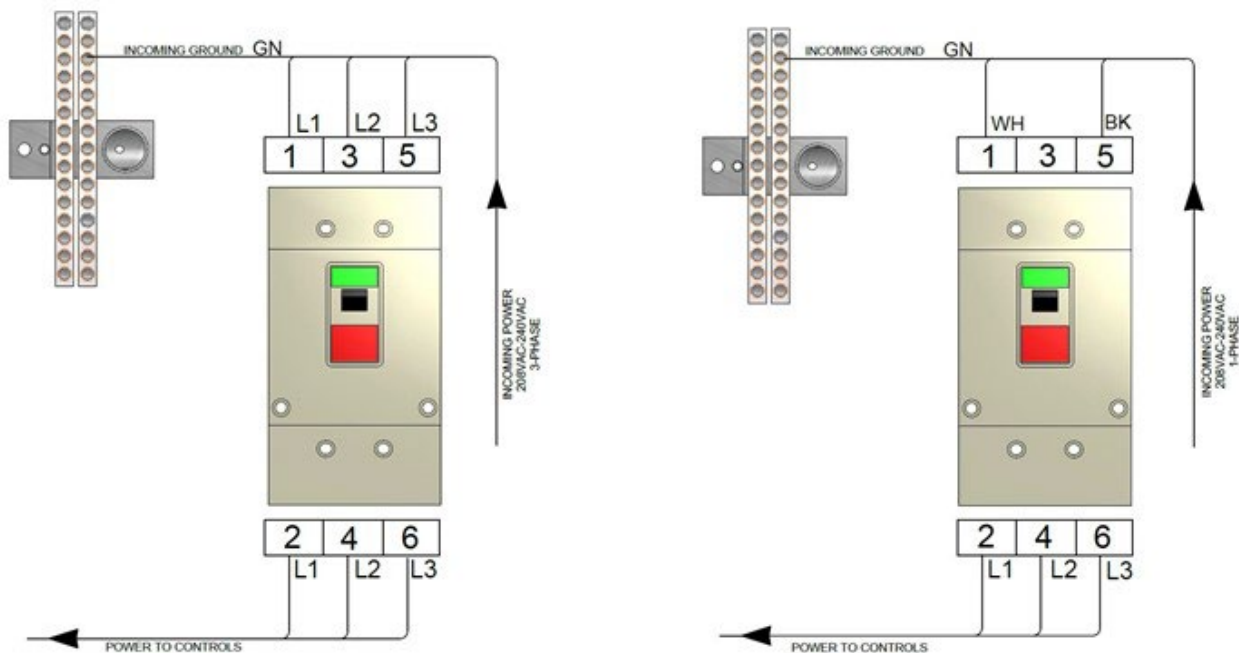

• Grounding

- The machine requires a good earth ground. The grounding conductor from the incoming power source must be connected to the grounding block located inside of the electrical cabinet. A ground rod installed in addition to the electrical service grounding conductor is permitted, but must be connected directly to the grounding block inside of the electrical cabinet. Connecting the ground rod to the machine base is not permitted. Consult a Licensed Electrician in your area to assess the installation, and install the appropriate ground rod if necessary. Failure to do so may lead to an installation that is unsafe and does not meet national and local electric codes.

Transformer Connections

This machine has the following minimum transformer size requirement:

- 10 kVA

If a transformer is necessary for machine installation, please refer to the diagram below for connection information. Transformers must be sized to meet the minimum power requirements listed above.

Consult a Licensed Electrician in your area for transformer selection and installation.

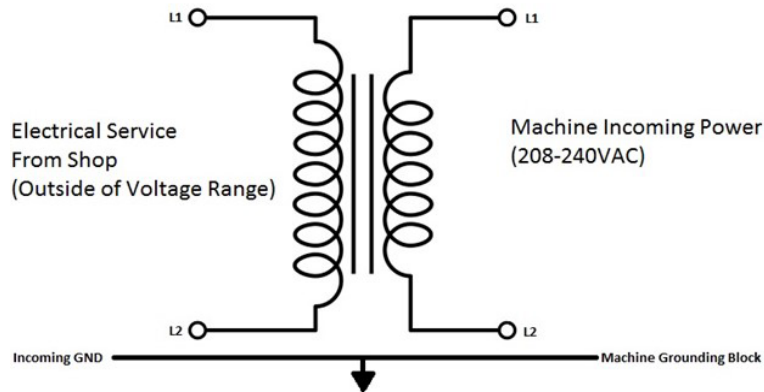

Creating a Skype Account

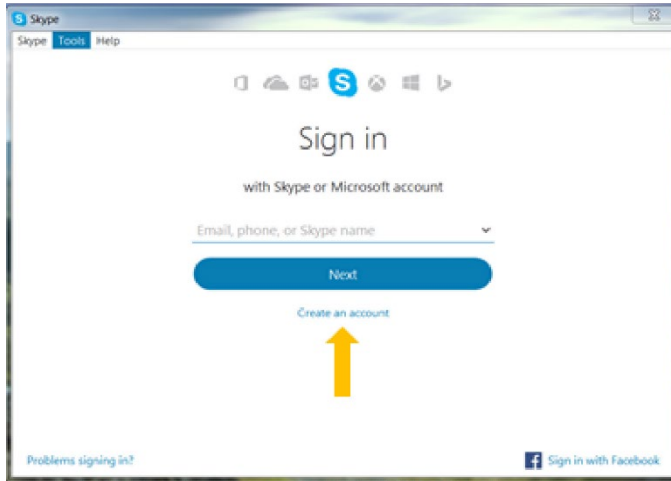

Click on create an account

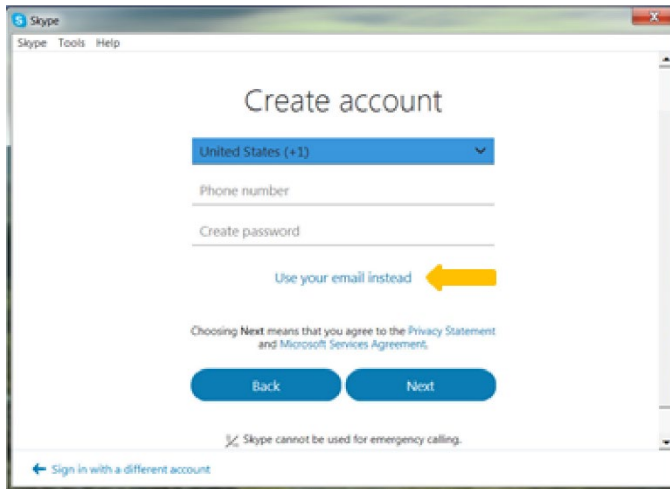

Click on: Use your email instead

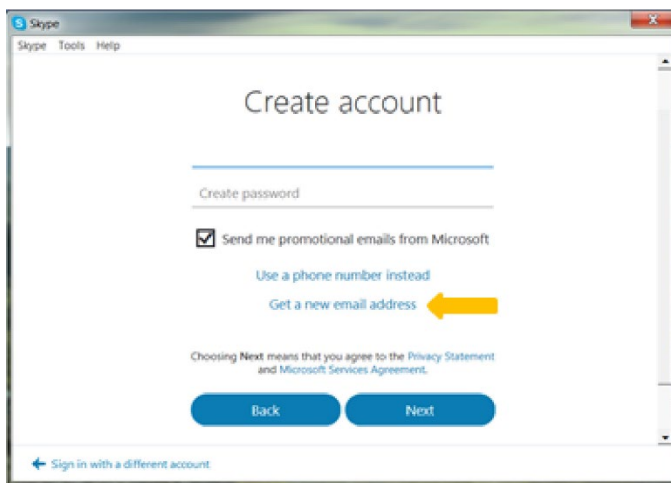

Click on: Get new email address

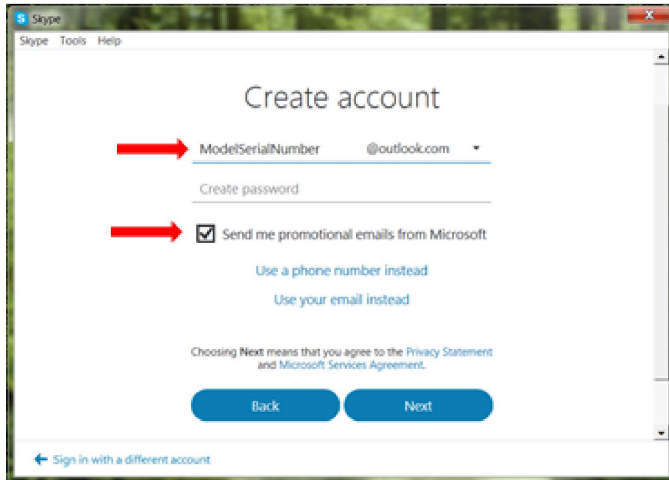

Name the email account using the Rottler machine Model and Serial number.
Ex: H85A111, EM69P001

Create a password that is easy to remember.

Uncheck the box to receive emails from Microsoft.

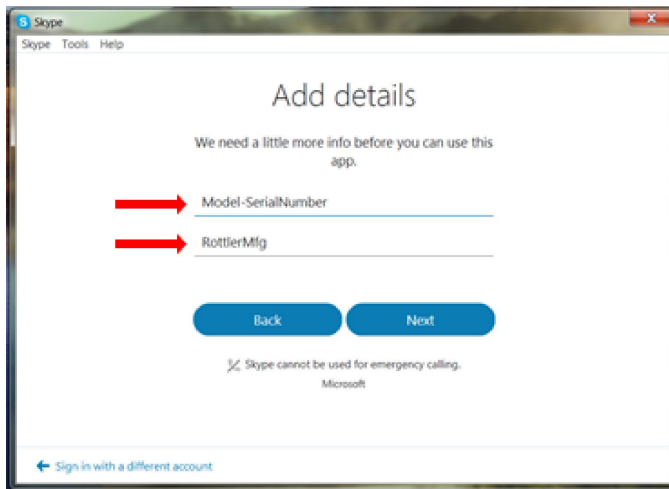

First Name: Model-Serial Number

Ex: H85A-111, EM69P-001

Last Name: RottlerMfg

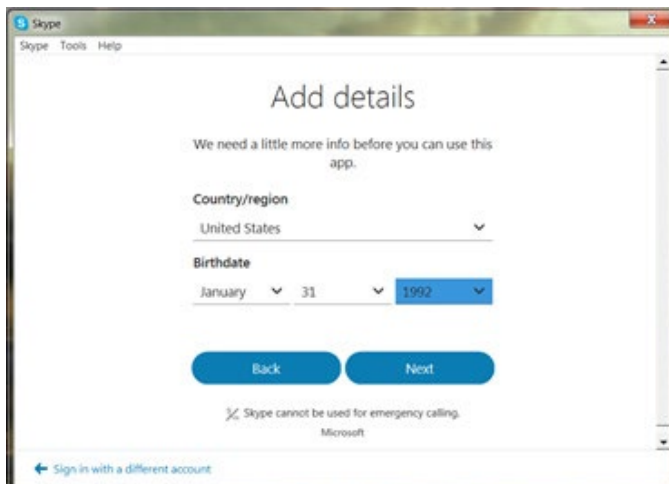

Select your Country/region

Birthday: Today's date, year 1992

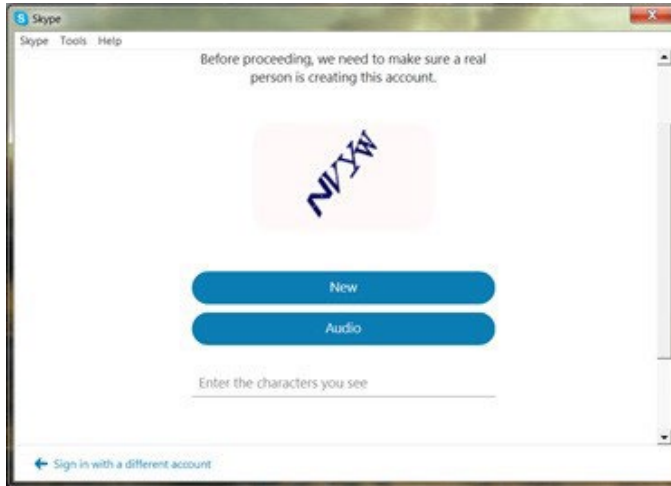

Type the code exactly as it appears.

Click "Next"

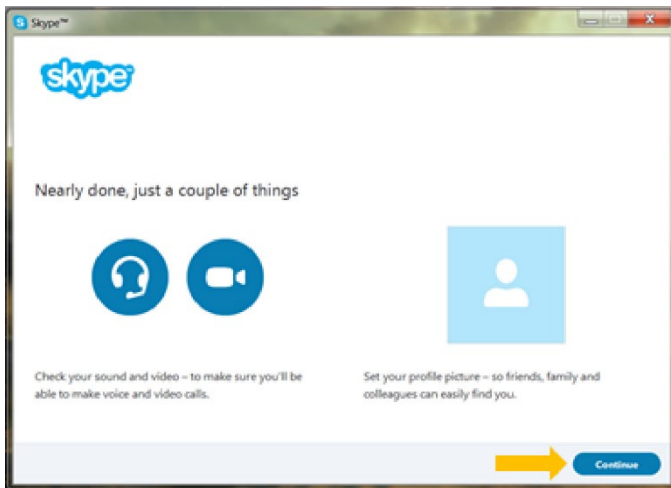

Click "Continue"

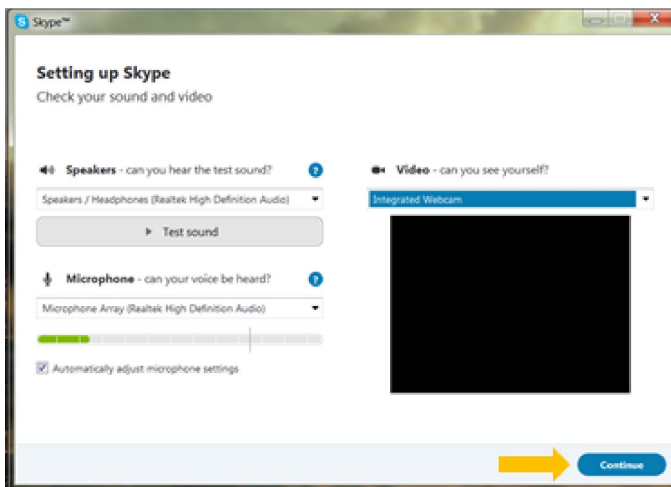

If your headset and/or web camera are hooked up you can verify that they are working here.

Otherwise, click "Continue"

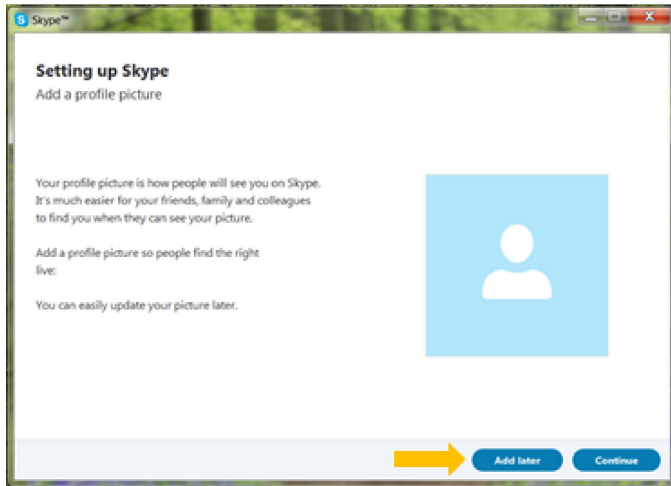

Click "Add later" to skip this part.

Your Skype account is set up and ready for use.