

ROTTLER

EM103/4/5H SERIES CNC MACHINING CENTER MACHINE INSTALLATION MANUAL



PARTS ORDERING

For optional equipment catalogs, please visit <https://www.rottlermfg.com/documentation.php>

For fastest service ordering parts or equipment, contact us via e-mail with the information below. For customers within the U.S., send emails to parts@rottlermfg.com, for customers outside of the U.S., use intlparts@rottlermfg.com

Have the following information on hand to expedite the ordering process:

1. Your name, business name, and contact number
2. Customer number, or your billing address if you do not have a customer number
3. Shipping address if different from the billing address
4. Machine model and serial number
5. Part number and description of the item(s) to order
6. Preferred method of shipment

For customers outside of the U.S. requiring faster service, contact your local distributor.

In some cases, you may be requested to send a photo of the part you are ordering if it is a replacement part or does not appear in our database.

If you are unsure which part you need to order, contact our service department, and ask to speak to one of our service consultants. They will assist you in determining which part(s) you require.

THERE IS A MINIMUM ORDER OF \$25.00

MANUAL SECTIONS

INTRODUCTION

INSTALLATION

INTRODUCTION

Contents

Introduction	1-1
Description	1-2
Disclaimer	1-2
Limited Warranty	1-3
Online Documentation Access	1-4

Introduction

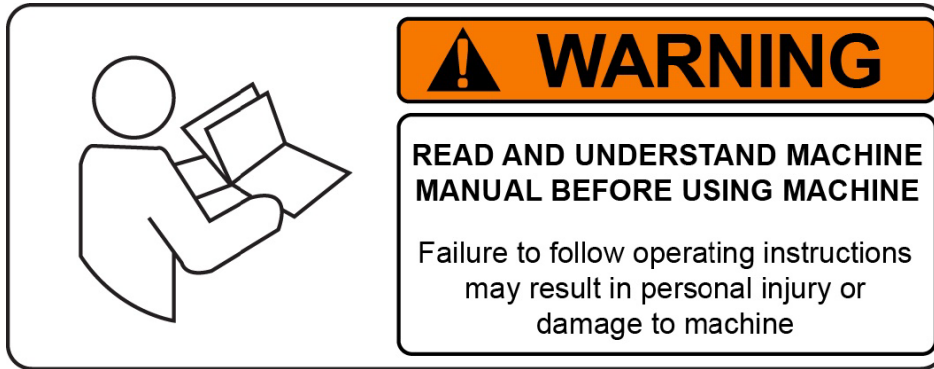

READ THE SAFETY SECTION OF THE OPERATIONS MANUAL BEFORE INSTALLING THE MACHINE. THOROUGHLY UNDERSTAND ALL SAFETY ISSUES BEFORE OPERATING MACHINE.

ATTENTION OWNER/BUSINESS MANAGER

To validate the warranty on your new Rottler machine, please be sure to sign and complete the “Installation Report” located in this manual.

We suggest that the new user(s) of the EM103/4/5H read the “Control Definitions” section of the Operations Manual to understand how the machine operates.

The “Operating Instructions” section of the Operations Manual should be read in order to familiarize the user with the actual button pushing sequences required to carry out a job. These sections in the manual should be considered an introduction. As the operator(s) of the EM103/4/5H series machine gain experience with using the different functions of the machine, complicated setups and programs will make more sense.

The Maintenance and Parts Manual contains information on part number references and routine machine maintenance. The operator(s) should read and become familiar with these areas as well.

Description

The model EM103/4/5H machine is a precision, single point boring, and high-speed surfacing unit. It can be equipped with tooling and accessories for surfacing and re-boring most medium to large gas and diesel engine blocks, both in-line and V-type.

EM103/4/5H machines can be easily tooled to machine a wide range of engines, including European and Asian engines. It can also be easily adapted to perform other boring and surfacing operations.

The machine is designed to maintain alignment of cylinder bores, cylinder heads, and deck surfaces to the pan rails and main bearing bore locations, as was done in the original factory machining. This overcomes the many inaccuracies and out-of-alignment problems associated with clamping portable boring bars to the cylinder head surface of blocks.

Convenient controls, fast block clamping, and precise 3-axis CNC positioning means considerable savings in floor-to-floor time and operator involvement.

Change over or resetting time required to set up V-type or In-line engines is minimized, making this machine highly suited to shops where engines cannot be run through in model lots.

All feeds and rapid travels are power operated and controlled from the control panel.

Disclaimer

The EM103/4/5H Manual (henceforth to be referred to as the “Manual”) is proprietary to Rottler Manufacturing LLC. (“Rottler Manufacturing”) and no ownership rights are hereby transferred. No part of the Manual shall be used, reproduced, translated, converted, adapted, stored in a retrieval system, communicated or transmitted by any means, for any commercial purpose, including without limitation, sale, resale, license, rental or lease, without the prior express written consent of Rottler Manufacturing.

Rottler Manufacturing does not make any representations, warranties or guarantees, express or implied, as to the accuracy or completeness of the Manual. Users must be aware that updates and amendments will be made from time to time to the Manual. It is the user’s responsibility to determine whether there have been any such updates or amendments. Neither Rottler Manufacturing nor any of its directors, officers, employees, or agents shall not be liable in any manner whatsoever to any person for any loss, damage, injury, liability, cost, or expense of any nature, including without limitation incidental, special, direct or consequential damages arising out of or in connection with the use of the Manual.

Rottler Manufacturing and its employees or representatives are not responsible for any information regarding final specifications of any workpiece that is created as a final product when using Rottler equipment. It is the responsibility of the end user of Rottler equipment to determine the final dimensions and finishes of the workpiece that they are working on. Any information regarding final dimensions and finishes that appears in any Rottler literature or that is expressed by anyone representing Rottler is to be regarded as general information to help with the demonstration of or for operator training of Rottler equipment.

Limited Warranty

Rottler Manufacturing Company Model EM103/4/5H parts and equipment is warranted as to materials and workmanship. This limited warranty remains in effect for one year from the date of installation or two years from the date of the original shipment from Rottler or whichever date occurs first. This only applies if the machine is owned and operated by the original purchaser and is operated and maintained as per the instructions in the manual. A machine is warranted only if the Installation Report has been properly executed by a certified installation person and received by Rottler at the time of actual installation.

The products are warranted upon delivery to conform to their published specifications and to be free from defects in material and workmanship under normal use for a period of one year from shipment. Should a product not be as warranted, Rottler sole obligation shall be, at its option, to repair, correct or replace the product or to refund the amounts paid for the Product upon its return to a location designated by Rottler. No warranty shall extend to rapid wear Products (including tooling) or to Products which have been subject to misuse (including any use contrary to Rottler instructions), neglect, accident (including during shipment), improper handling or installation, or subject to any modification, repair or service not certified by Rottler. Rottler shall not be liable for any consequential, direct or indirect damages or for any other injury or loss. Buyer waives any right, beyond the foregoing warranty, to make a claim against Rottler. No warranty is provided for any Products not paid in full.

Merchandise cannot be returned to Rottler without prior approval. Customer must contact the Parts Department to get approval and to be issued a Return Goods Authorization number (**RGR#**). Merchandise authorized for return must be returned prepaid. If merchandise is returned with shipping charges collect, the actual amount of these charges may be deducted from any credit which may be due the customer. The **RGR #** assigned by the Parts Department should be written on the shipping label and must appear on a copy of the invoice(s) covering the original shipment. This invoice copy must be included in the box with the parts. Shipment must contain **ONLY** those items on the **RGR** as approved for return. Merchandise must be received within 10 days of the date of **RGR** or the **RGR** will be canceled. All returned merchandise may be subject to a 20% restocking fee on under \$1,000.00 amount or 10% on any items over \$1,000.00. Parts or tooling over 30 days old are considered as customer property and can only be returned with prior approval from Rottler Corporation Management.

The issuance of a **RGR DOES NOT** guarantee credit - it is only authorization for the return of the goods. Credit for return merchandise is at the sole discretion of Rottler. Credit will be issued only after inspection of returned goods.

Tools proven to be defective within the warranty period will be repaired or replaced at the factory's option.

We accept no responsibility for defects caused by external damage, wear, abuse, or misuse, nor do we accept any obligation to provide compensation for direct or indirect costs in connection with cases covered by the warranty.

Online Documentation Access

Online documentation for machines and optional equipment, including manuals and catalogs, can be accessed at the Rottler website. To access documentation, open your browser and navigate to <https://www.rottlermfg.com>

Scroll to the bottom of the page and under the “Owner Resources” title, click the type of documentation you want to access.

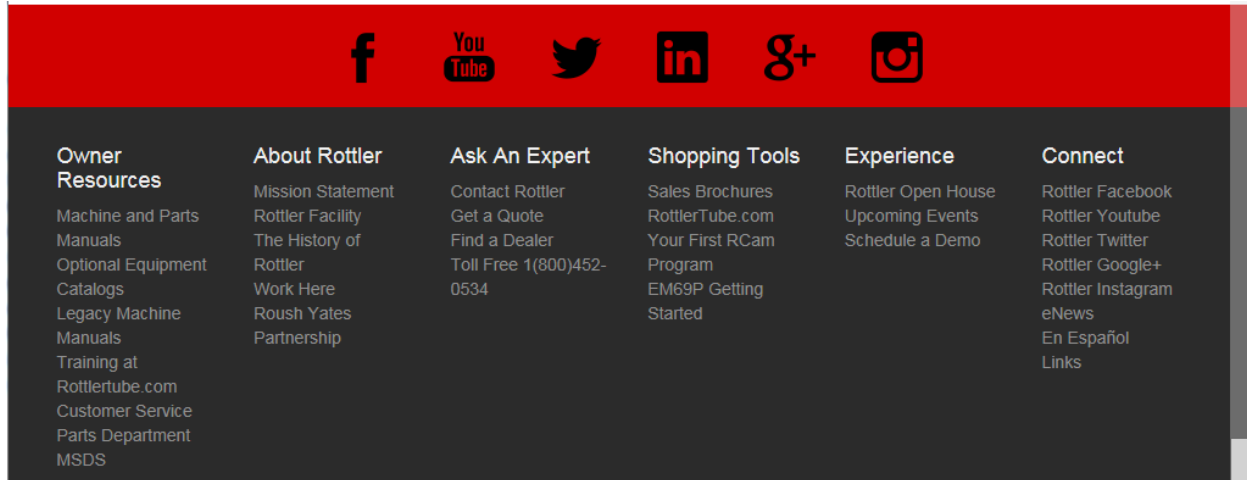

If a log-in window pops up asking for a user name and password, fill in the blanks as shown:

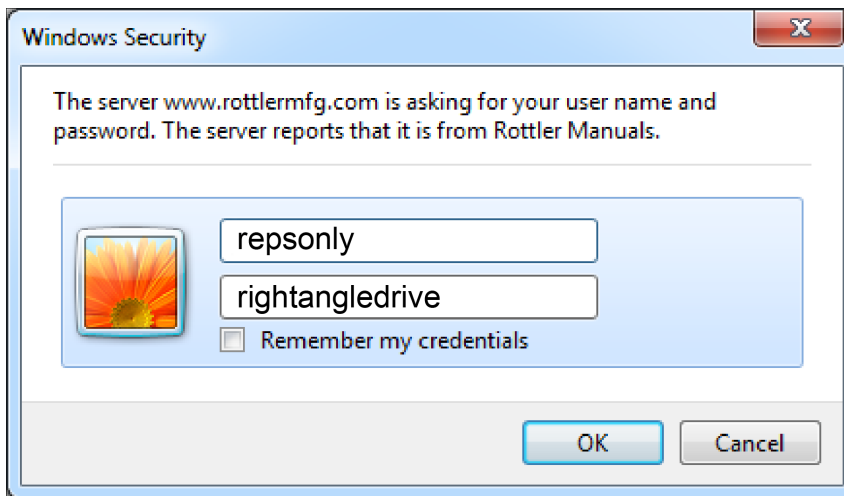

INSTALLATION

Contents

Installation Preparation Requirements	2-1
Installation Report	2-3
Removing Machine from Shipping Container.....	2-11
Installation Procedure	2-13
Rottler EM103/4/5H Foundation and Hold Down Requirements.....	2-13
Lifting Machine with Provided Lift Eyes	2-14
Location.....	2-17
Unpacking	2-17
Column Hold Down.....	2-17
Leveling	2-17
Air Supply.....	2-18
Power Supply	2-19
Grounding	2-20
Transformer Connections	2-20
Phase Converters	2-20
Setting Soft Limits	2-22
Creating a Skype Account.....	2-25

INSTALLATION CUSTOMER PREPARATION REQUIREMENTS

1. The floor needs to be prepared with anchor bolts installed. Rottler highly recommends the Hilti system.
2. Machine needs to be set in place with a leveling pad under each leveling bolt. After setting the machine in place, check that each anchor bolt nut turns freely and that there is no damage to the anchor bolt threads.
3. Rough level the machine.
4. Electrical connection made to the machine. Provide 208-240 VAC 3 phase power. 60 amp service is required (80 if using a Vertical Lathe)
5. Air supply to the machine. Minimum 100 PSI of clean, dry air.
6. Fixtures removed from the machine bed and cleaned of rust preventative.
7. Machine cleaned of rust preventative
8. Machine requires an Internet connection, preferably wireless.
9. Have a scrap block available for operator training, preferably a block commonly repaired at your facility.

ATTENTION OWNER/BUSINESS MANAGER

To validate the warranty on your new Rottler machine, please complete and sign the installation report after the installation technician has installed the machine, verified the machine is operating correctly, and given the operator(s) operation and maintenance training.

Thank you for your cooperation and the opportunity to be of service to you.

ROTTLER MANUFACTURING



INSTALLATION REPORT

EM103/4/5H

REV 091720

OFFICE USE ONLY

Route to:

Parts _____ Service Mgr _____ Assem Mgr _____ Eng Mgr _____ Parts _____ Andy _____ Parts _____

Warranty Exp Date _____

ROTTLER MANUFACTURING MUST HAVE THIS REPORT RETURNED TO PROPERLY QUALIFY WARRANTY ON EQUIPMENT

Customer: _____ Address: _____

City: _____ State: _____

Country: _____

Machine Model: _____ Serial Number: _____ Representative: _____

MACHINE INSTALLATION: Electrical information MUST be complete to validate this report.

_____ Customer has read and fully understands the importance of machine location as explained in the installation section of this manual.

The following is the customer’s responsibility prior to the arrival of the Rottler technician. Please initial each item when it is completed.

Customer must provide foundation and hold down bolt system, see the foundation drawing and the “Foundation and Hold Down Requirements” section of this manual.

CAUTION **VERY IMPORTANT:** Modern machines contain electronic low voltage circuitry that provides great advantages and a better machine life. BUT you must have an excellent, stable power supply and a good earth ground. If not, electrical noise problems are likely to interfere with machine operation unexpectedly.

Customer is responsible for providing electricity to machine in a manner that meets the electrical code requirements.

_____ Remove machine from truck. Weight: EM103 14,000lb (6,350kg), EM104 16,000lb (7,257kg), EM105 18,000lb (8,165kg)

_____ If the machine was shipped in a container, follow the removal procedure in the installation section of the manual.

_____ Remove fixturing and misc. parts from machine and clean off the rust preventative.

_____ Install the machine on the foundation with supplied jack pads under the jacking bolts.

_____ Install hold down nuts and bolts. This must be done first.

_____ Rough level the machine using a precision level so there is equal tension on all bolts.

_____ This machine requires between 208 and 240 Volts AC, 3-Phase, 50/60Hz power supply. For voltages above or below this range a 30kva transformer will be required. Measure the incoming voltage between L1 and L2, L2 and L3, and L1 and L3. 60amp (80 with vertical lathe) is required for this machine. Measure the incoming AC Voltage at least twice during installation.

1. L1 to L2 _____ L2 to L3 _____ L1 to L3 _____
2. L1 to L2 _____ L2 to L3 _____ L1 to L3 _____

_____ Measure each leg of the incoming supply to ground. Sometimes you may find a “high” leg to ground. When this happens, ensure that the high leg is running to L3.
 L1 to Ground _____ L2 to Ground _____ L3 to Ground _____

**CAUTION**

Neutral and machine ground are not the same thing. You should measure an open circuit between Neutral and ground.

**CAUTION**

IF VOLTAGE IS OUTSIDE OF THE CORRECT RANGE AT ANY TIME, THE MACHINE WILL NOT OPERATE PROPERLY AND MAY BE DAMAGED.

**IMPORTANT**

AIR REGULATOR SHOULD BE SET AT 120PSI (8.3 BAR), MINIMUM SHOP SUPPLY SHOULD BE 100PSI (6.9 BAR).

_____ Air of the proper pressure and capacity connected to the machine. Air supply must be free from oil and water. Oil or water will damage electrical and air components.

_____ Customer should attempt to have a junk work piece available.

_____ Have the operator(s) read through the Operation Manual before training begins. This will help them be familiar with the button pushing sequences. Have the operator(s) re-read the manual after training.

_____ Have an Internet connection available for the machine, either via ethernet cable or wireless. The machine comes with a USB Wireless adapter.

The following is the Rottler technician’s responsibility

_____ Remove the top and left-side rails from the Column.

_____ Check the column top and spindle base bottom for rust and nicks, clean and stone as required.

_____ When lifting the spindle unit, keep in mind that the center of gravity is located approximately 12in (305mm) from the front.

_____ The electrical system is protected internally by circuit breakers. Verify that the breakers are set correctly. Green indicates that the breaker has “tripped” and red indicates the breaker is “hot” (conducting electricity)

_____ Clean any rust inhibitor from the machine surfaces. Move the column from side to side to ensure all surfaces are clean.

_____ Install the spindle unit on the column using one of the approved methods described in this manual. (Spindle unit weighs 3,800lb, 1,724kg)

Using forklift angle brackets

_____ Bolt brackets to each side of the spindle base.

_____ Use large C-clamps to clamp the forks to the brackets. This will prevent any accidental slips.

_____ Use a forklift to lift the spindle unit onto the column. Be careful to watch the clearance of all items.

_____ Lightly coat the spindle base ways with oil

_____ Carefully push the spindle base against the installed side rail.

_____ Install the left side rail (9202A) with 2 belleville washers (9024E) opposing each other () on each set screw (9202D) and 2 turcrite pucks (10003L), torque side rail bolts to **80 ft-lb**.

_____ Adjust the set screws (9202D) on the SIDE rails by tightening them until they bottom out, then unscrewing them by 1/8 turn and lock the jam nuts.

_____ Measure the protrusion of the siderails above the spindle base and record:

Right: Front _____ Rear _____

Left: Front _____ Rear _____

_____ Install the left and right top rails (9202B) with 2 belleville washers opposing each other () on each set screw (9202D) and 2 turcrite pucks (9024A). Torque to **80 ft-lb**.

_____ Adjust the set screws (9202D) on the TOP rails by tightening them until they bottom out, then unscrewing them by 5/8 turn and lock the jam nuts.

- _____ Remove brackets from the Spindle Base.
- _____ Connect air and oil lines per the Pneumatic Schematic
- _____ Remind customer of the proper air pressure and capacity connected to the machine. Air supply must be free from oil and water. Oil or water will damage electrical and air components.
- _____ Connect electrical wires in the main enclosure per the wiring diagram.

MACHINE START-UP



CAUTION

When starting up the machine for the first time, it may move without control input. Make sure all hands are clear of the machine parts. Be ready to engage the emergency stop if needed.

- _____ **BEFORE** turning power on to the machine. Check all wires for security by using the correct screwdriver and tightening each screw until bottomed. Stranded wire can spread slightly from vibration during transport.
- _____ Install electrical component covers inside the electrical enclosure with provided fasteners.
- _____ Turn main power on at the main disconnect switch located on the rear enclosure.
- _____ If the machine moves without control input, immediately turn the power off and contact the factory for help troubleshooting.
- _____ If any of the circuit breakers trip, reset and call the factor for help troubleshooting.
- _____ Install and test the internet connection to the machine DO NOT download any updates unless instructed by Rottler.
- _____ Check the computer control options and make sure that you turn on Z-Axis 2 and Spindle bit 3.

MACHINE MOVEMENTS

- _____ Put the machine into Y-Axis handwheel mode, 0.001" increment, and slowly move the Y-Axis until the ballscrew mount plate is aligned with the bolt holes in the spindle base. Bolt together and torque to **43 ft-lb**
- _____ Make sure there is nothing obstructing the full X-, Y-, and Z-Axis travel of the machine, taking special notice of the rear enclosure, way travel, and top of the spindle unit.
- _____ Put the machine in handwheel mode and verify Z-Axis operation. Place an indicator on the cutter head and verify 0.001" movement per detent in course mode and 0.0001" in fine mode. If the indicator moves in larger jumps, the outer spindle bushings may be too tight. Refer to the Maintenance and Parts Manual for adjustment instruction.
- _____ Put the machine in handwheel mode and verify X-Axis operation. Put an indicator on the cutter head and verify 0.001" movement per detent in course mode and 0.0001" in fine mode.
- _____ Use the rapid buttons and verify proper X-, Y-, and Z-Axis travel.
- _____ Check that the software travel limits are operating by using the handwheel at each end of travel before using the automatic feed:
 - _____ Z-Axis limit operation verified (Bore Mode)
 - _____ Z-Axis limit operation verified (Line Bore Mode)
 - _____ X-Axis limit operation verified
 - _____ Y-Axis limit operation verified

- _____ Start the spindle to verify operation at all speeds.
- _____ Use the spindle creep buttons to verify proper operation
- _____ Prime the oil system. (See the Maintenance and Parts Manual for instruction).
- _____ Use a precision level to level the machine to within 0.0005" and record:

Back Linear Rail:

P1_____ P2_____ P3_____ P4_____ P5_____ P6_____ P7_____ P8_____

Back Rail to Front Rail:

P1_____ P2_____ P3_____ P4_____ P5_____ P6_____ P7_____ P8_____

Front to Back of Table:

P1_____ P2_____ P3_____ P4_____ P5_____ P6_____ P7_____ P8_____

Record Dial Indicator readings:

Spindle to Back of Table:

P1_____ P2_____ P3_____ P4_____ P5_____ P6_____ P7_____ P8_____

Spindle to Front of Table:

P1_____ P2_____ P3_____ P4_____ P5_____ P6_____ P7_____ P8_____

- _____ Verify that the tool change function operates correctly
- _____ Check mill tilt and lift amounts with the Y-Axis in the middle of its travel and record:
Amount of tilt _____ Amount of lift _____
- _____ Adjust the outer spindle bushings (See the Maintenance and Parts Manual for instruction)
- _____ Adjust the inner spindle bearings (See the Maintenance and Parts Manual for instruction)
- _____ Perform spindle sweep adjustment and record. (See Maintenance and Parts Manual for instruction and rottlertube.com for a video walkthrough)
Back _____
Left _____ Right _____
Front _____

- _____ Verify ALL axis backlash compensations are operating properly, adjust if needed. Record readings after verification:

	Auto	Handwheel
X-Axis	_____	_____
Y-Axis	_____	_____
Z-Axis	_____	_____

- _____ Install way cover brackets and way covers. Way cover support brackets should be flush with linear bearing surfaces.

INSTRUCTING THE OPERATOR

Note: Rottler employees and representatives, per company policy, are not permitted to provide the end user of Rottler equipment with any OEM specifications for the workpiece that is created by the end user of Rottler equipment.

WARNING

- _____ Explain to the customer and operator(s) that at NO time is there to be any software or hardware other than Windows Auto Update and Rottler Software installed on this machine. This includes screen savers, anti-virus software, and any hardware device that installs software on the machine. Installation of unauthorized software can cause dangerous control problems. Any installation of unauthorized software or hardware will void the warranty on the machine.
- _____ Explain to the customer and operator(s) that the machine should be connected to the Internet anytime it is turned on. The software on the machine will automatically connect to our server to send useful machine status information.
- _____ Connect customer supplied internet to the machine and verify that the internet is accessible.
- _____ Once the machine has been fully set up and is ready for operation, create a Skype account (instructions in this manual)
- _____ Explain to the customer and operator(s) how to log onto Skype and communicate with Rottler when needed.

WARNING

- _____ Computer viruses will cause the machine control system to become unstable. This may cause the machine to make uncontrolled movements which could create a dangerous environment for the machine operator(s).

IMPORTANT

_____ Have the customer review the “Control Definitions” chapter of the Operations Manual, Section “Computer and Controller System Safety and have them sign off. Failure to do so will result in the machine warranty being Null and Void.

Signature/Title

_____ Explain to the customer the importance of backing up the block profiles to a separate device. Any computer failure or possible operator input error can result in the loss of all block profiles that were created for the machine. Refer to the Operations Manual for instruction.

_____ Explain the function of all buttons using the Operations Manual.

_____ Cycle all machine movements and supervise the handling of these movements by the operator(s)

_____ Demonstrate the differences between manual and automatic operations.

_____ Fully explain the entire Auto Cycle from Centering to Auto Retract

_____ Explain machine parameters and error messages. It is very important that the customer does not change parameter settings without first checking with Rottler Manufacturing. If certain parameters are changed, the machine may make uncontrolled moves or not operate at all.

_____ Point out safety features to the customer and operator(s). Do not push any buttons without thinking of safety first.

CAUTION

Do not assume that the cutterhead micrometer has been calibrated.

_____ Install a work piece in the machine and perform an undersized test bore to qualify the micrometer setting to the customer’s measuring tools.

_____ Explain precision reset of tool in cutterhead.

_____ The following is a checklist to go through every time the machine is started before beginning a cut or automatic cycle:

1. Work piece secure
2. RPM set
3. Feed rate set
4. Correct program in use
5. Guards in place
6. Cutterhead secure
7. Tool holder adjusted to the correct size
8. Tool holder locked in place

_____ Proceed to have operator bore block to size.

_____ Demonstrate and explain boring with the electronic hand wheel.

_____ Explain the correct Feed rates and Speeds from the Cutting Insert Bulletin.

_____ Explain cutterhead changes and expected stub bar performance.

_____ Explain Parts ordering, refer to the Maintenance and Parts Manual for part numbers

_____ Explain offset tool bits, calibration of micrometers, and anvil setting

_____ Train the operator(s) on ALL Rottler programs, even if they need to be run in the air.

_____ If Rottler CAM was provided to the customer, train on any programs supplied by Rottler.

_____ Review Emergency Stop procedure with operator per the Operations Manual.

MAINTENANCE SECTION

_____ Use the Maintenance and Parts manual to explain routine maintenance and lubrication

_____ Overload devices: There are no mechanical overload devices on this machine. The machine is protected from overload by the motor controllers. If the system is overloaded, the controllers shut off the motors. The controllers can be reset by turning the main power off for at least 1 minute, then turning it back on.

- _____ Explain again the proper Inner and Outer spindle adjustment to the operator.
- _____ Explain dampener cleaning
- _____ Explain micrometer and anvil thread adjustment.
- _____ Explain the inspection of the tool bite hole in tool holders (deformation due to accidental impact)

Rottler Manufacturing and its employees or representatives are not responsible for any information regarding final specifications of any workpiece that is created as a final product when using Rottler equipment. It is the responsibility of the end user of Rottler equipment to determine the final dimensions and finishes of the workpiece that they are working on. Any information regarding final dimensions and finishes that appears in any Rottler literature or that is expressed by anyone representing Rottler is to be regarded as general information to help with the demonstration of or for operator training of Rottler equipment.

Note: Rotter employees and representatives per company policy are not permitted to provide end user of Rottler equipment with any OEM specifications for the workpiece that is created by end user using Rottler equipment.

General remarks on machine performance, adjustments as received and any further organization or parts required to complete the installation.

Instruction given to: _____

Sales/Service Technician: _____ Date: _____

Shop Foreman, Superintendent, or Owner: _____ Date: _____

Once completed send this form to:

**Rottler Manufacturing
attn: Orders Department
8029 S 200 St
Kent, WA 98032 USA**

Alternately you may send this form via fax or e-mail:

**fax: [+1] 253-395-0230
e-mail: orders@rottermfg.com**

Removing Machine from Shipping Container

All EM100 machines that are shipped in a container must be unloaded using the following method.

Machines will be loaded into containers at the factory mounted on metal tubes. These tubes will facilitate the sliding of the machine out of the container.

If the machine is to be removed from the container for transfer to its final destination the seal must not be broken.

Use lifting straps or chains placed through the tubes to pull the machine from the container. Make certain that the machine is clear of the container before attempting to lift machine.

The photo below shows the machine packed and sealed for placement into a container.



The photos below show the tubes that the machine sits on. Place straps or chains through these tubes to pull the machine out of the container. Take care not to damage the threads of the bolts holding the tubes to the machine.

**WARNING**

Using an alternative method to remove the machine from the container that results in damage to the foil packaging seal or to the machine itself could result in the warranty being voided.

Installation Procedure

Foundation and Hold Down Requirements

Rottler machines require a good concrete foundation and hold down system. It is not recommended to install a machine on a cracked floor or over an expansion joint. The layout/position of the hold down holes can be found on the foundation drawings. Below are Rottler's recommendations based on customer feedback and experience, we encourage customers to consult with a local specialist to determine the exact foundation needs based on their local conditions.

There are two methods commonly used by customers:

- 1) Drill the concrete floor as per drawing layout before arrival of machine. Foundation drawings are available on the Rottler website or by request.
- 2) Place machine, mark floor through holes in machine base, move machine away then drill the floor.

The machine is provided with jacking bolts and steel pads to place between the jacking bolts and floor. For shipping, the steel pads are packed in a separate box and marked with yellow/black tape so the box is clearly visible. This allows the machine to be unpacked and removed from the shipping crate, placed on the floor on these steel pads without opening the accessory crates. When placing the machine on the jacking bolts, ALWAYS rough level to be sure that the weight of the machine is evenly distributed over all the jacking bolts.

Rottler recommends Hilti products with 3/4" (20mm) diameter X 12" (300mm) long studs at a minimum. **It is the customer's responsibility to determine the appropriate anchors for local conditions.** Drill floor approximately 7" (180mm) deep with 1" (25mm) drill. As it is difficult to drill concrete exactly on center, it is recommended to drill a pilot hole. After drilling and before injecting epoxy, it is also recommended to move the machine into place and make sure all studs fit through the holes in the base and travel all the way down into the holes so that approximately 5" (130mm) protrude out of the floor. The machine may have to be moved a small amount to allow all studs to fit. Once this is checked, the studs can be removed then the epoxy injected into the bottom of the holes. Make sure all dust is vacuumed out of the holes before the epoxy is injected. Ensure that the epoxy is injected starting at the bottom of the holes to be sure the stud has maximum contact with the epoxy. The size of the holes will determine how much epoxy to inject into the holes before fitting the studs. On average, 1/2 to 2/3 of the hole should be filled with epoxy before the stud is installed. Be sure when the stud is installed, that the epoxy fills the hole to the top. Fit the washer and nut and tighten lightly to align the stud then allow the epoxy 24 hours to harden ready for leveling and final anchoring.

The column is tied down with chains for transport, if it is required to move the column to help with installation of the hold down system, the column tie downs can be removed and manually turn the horizontal ball screw nut by hand to move the column sideways. Be sure that the rails are clean and lubed under the column before moving.

The following is a **MINIMUM** recommendation for safe reliable operation.

- 4000 PSI concrete
- Slab thickness of 12" (30cm)

Any slab that is thinner than this may require monitoring of levelness of the machine. It is the customer's responsibility to determine the appropriate flooring for local conditions.

Lifting Machine with Provided Lift Eyes



Lifting a machine using the following method is a dangerous and demanding procedure. Therefore Rottler recommends that the customer hire a licensed and bonded material handling specialist. Rottler will not be held liable for and consequences resulting from mishandling of the machine using this method.

Observe the following precautions:

1. Check the machine invoice to see what the shipping weight was and be certain that the hoists to be used ratings exceed that weight.
2. Be certain that all rigging used is rated for the weight that will be lifted.
3. Check lift eyes for damage and for secure attachment.
4. Nylon straps are preferred over cable and chain in order to prevent damage to machine.



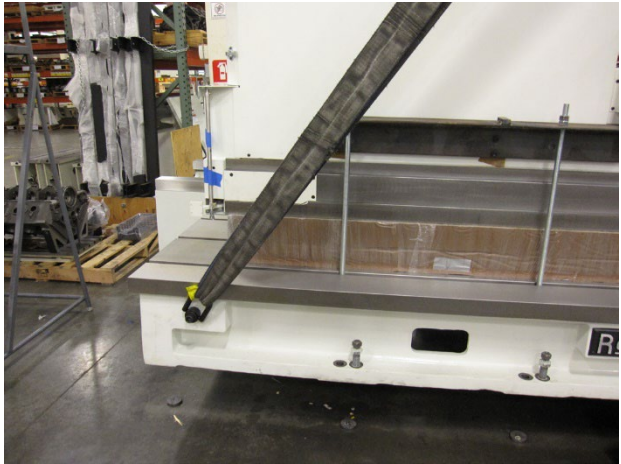

Machine Dimensions

Left Side View

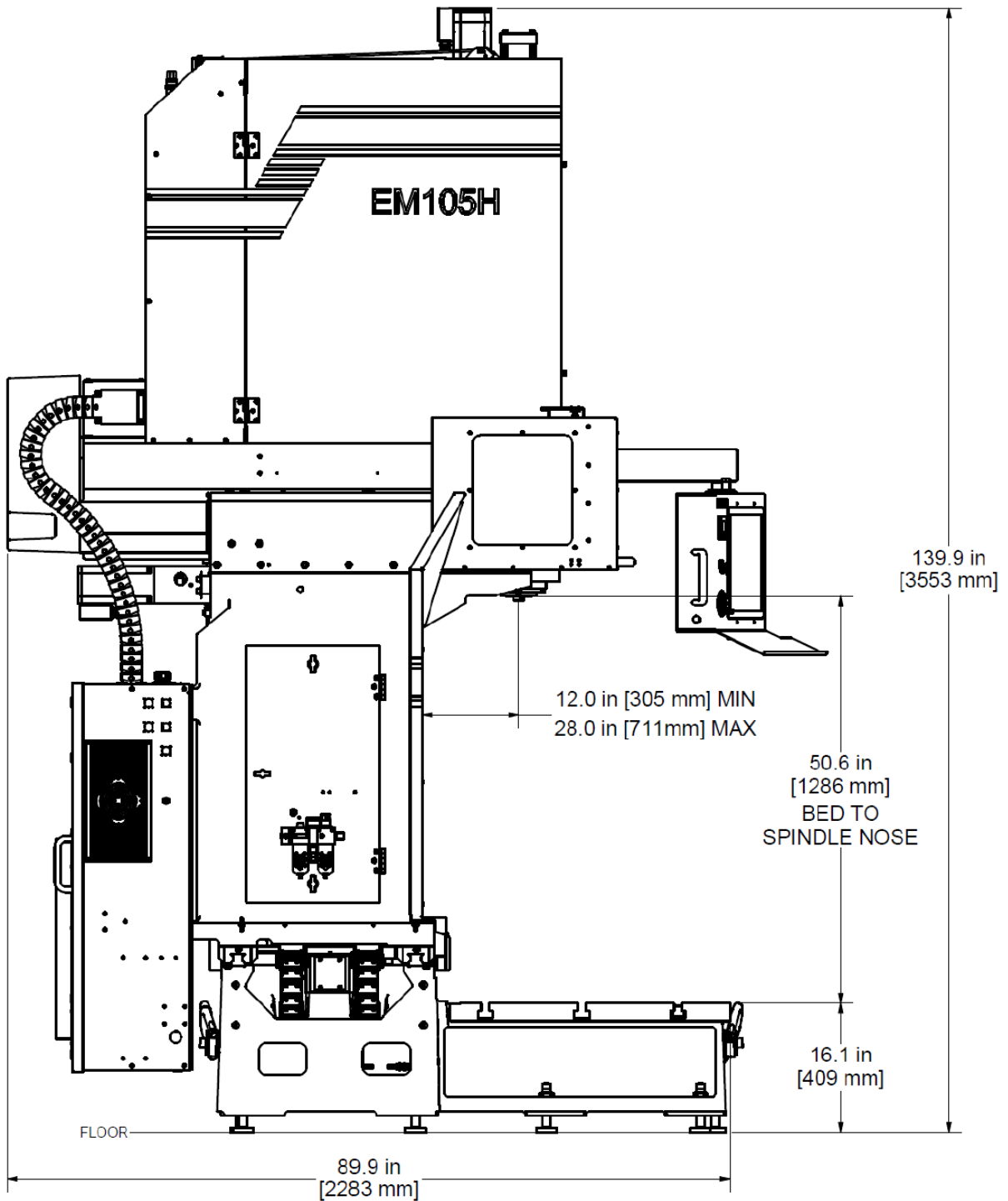

**IMPORTANT! Placement of Machine**

It is critical that the machine be placed in an area of the facility that has a stable thermal environment. The machine should be kept away from direct sunlight, large heating units, and doorways that would allow outside air direct contact on the machine.

Exposure to the above and other extremes in temperature will cause thermal drift to occur in the machines which could have a detrimental effect on machining accuracy. A number of unrepeatable errors in machine performance have been linked to this condition.

Location

The productivity of this machine will depend a great deal on its proper initial installation. Pay particular attention to the means by which work pieces are lifted into the machine as well as the material handling to and from other operations in your shop.

The proper loading arrangement and area location for your EM103/4/5H machine is extremely important.

A slow travel (6' to 10' per minute) power hoist, operated from either a bridge crane or a jib crane arrangement works very well. Verify the hoist has a rating that exceeds the load being lifted.

For shops where large production runs are anticipated, the work pieces should be directly loaded and unloaded from a conveyor. If this is not the case we recommend considerable attention be given to the crane so that it covers an adequate area, to allow the operator to back up and remove work pieces without creating a dangerous, cluttered work area.

Unpacking

Use care in removing the crate materials from the machine. Be careful not to use force on any part of the machine.

Remove the toolbox, parallels and optional equipment from the machine. Completely clean these articles as well as the rest of the machine with solvent. Rust inhibitor was applied at the time of shipment. Any of this left on the machine, will allow cast iron dust to collect in that area, which could cause premature wear.

Column Hold Down

The machine was shipped with the column held in place with chains and turnbuckles to the Main bed. Do not attempt to move the machine under power until these restraints have been removed.

Leveling

Located in the bottom of the main base are the leveling and tie down screws. If care is taken, the main base can be leveled extremely accurately. Start by placing the jacking pads under the jacking screws. Adjust the jacking screws so the lowest point of the main base is at least 1/4" off the jacking pad. Make sure all the jacking screws are touching their jacking pads. Use a precision machinist's level, and check the base at several points to get an idea where the high and low spots are, adjust evenly where necessary. Start with the back linear rail. With your precision level, level the back linear rail in the lengthwise direction to .0005" per foot. Take the readings approximately mid way between the jacking points.

Use a precision metal support to span the distance between the front and rear linear rails. (Support must be parallel within .0005" in its length). Take readings over every jacking bolt and level within .0005" over the length of the base. Be sure to use the jacking points down the middle of the main base.

Recheck the linear rails for level. Now check the machine table. Using the front jacking screws level the table within .0005" in both directions.

Be sure that all jacking bolts have approximately equal weight on them. As you level the base, snug the anchor bolts to help hold the main base in place. Recheck all areas of the main base for level.

Air Supply

It is very important that the air source for the EM103/4/5H machine be moisture free. Water and oil in the line will result in early cylinder and valve failure. The factory recommends installing a water trap at the machine.

Attach a 100 PSI air source to the appropriate intake in the small enclosure located on the right-hand side of the machine near the bottom.

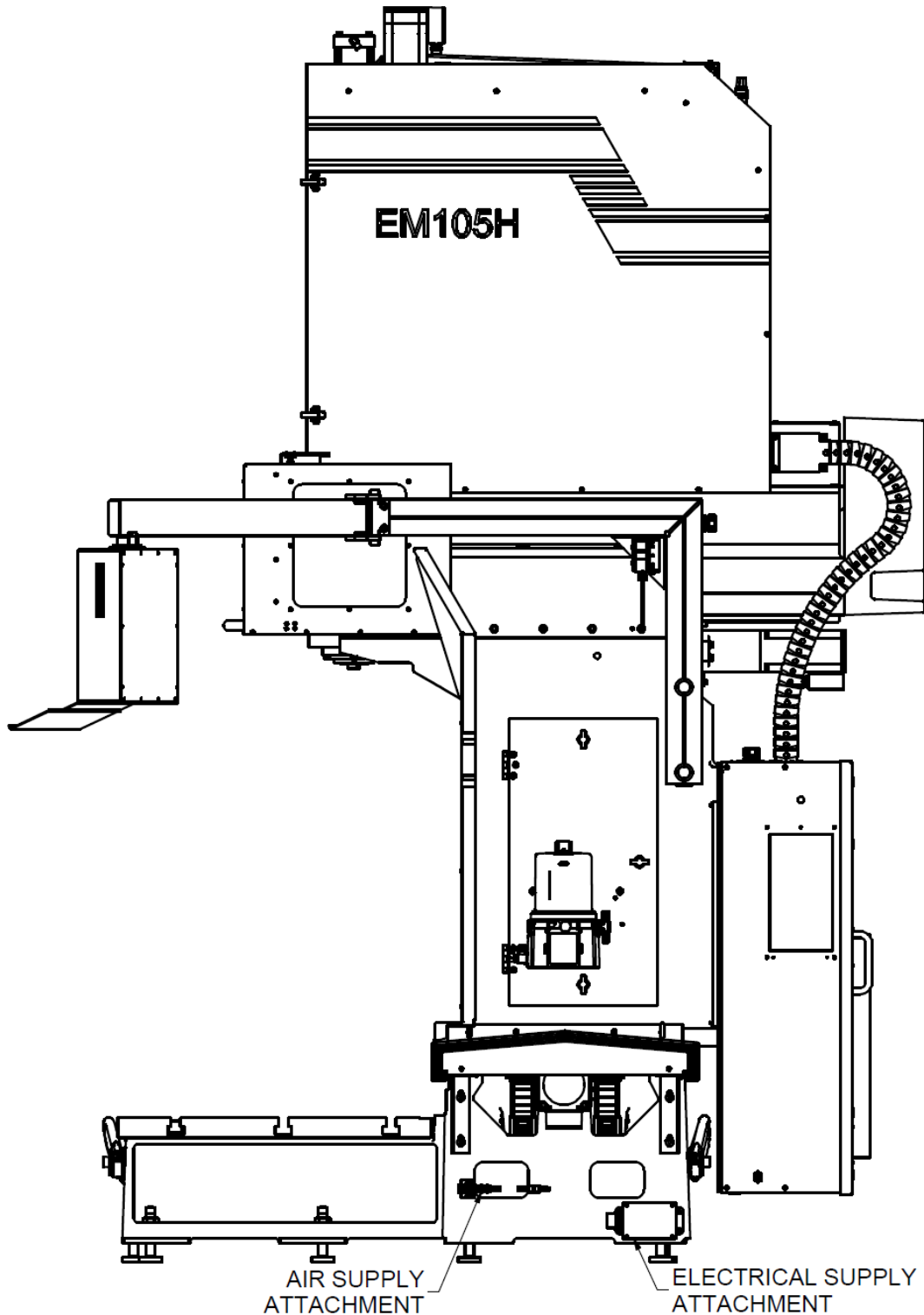

Power Supply

This machine has the following power requirements:

- 208 to 240 VAC
- Three Phase
- 50 or 60 Hertz
- 60 amps

See illustration below for correct connection of incoming power. Measured power at the machine's main breaker must be within the required range listed above. If incoming power is not within range, a transformer must be used. Failure to do so will cause the machine to function abnormally and cause permanent damage to the electronic control system.

Some electrical services contain a "Hot Leg, High Leg, or Wild Leg", where one leg measures 208VAC to Ground instead of 120VAC. It is required to use the "Hot Leg" for L3 when connecting the machine. Voltage measured between the phases must be between 208VAC and 240VAC, while phases 1 and 2 to ground must be ~120VAC. Phase 3 to ground is allowed to measure up to 208VAC.

IMPORTANT

Electrically connect in accordance with national and local electrical codes.



CAUTION

**Do not attempt to connect more than 240 VAC to this machine.
Do not attempt to connect to Single Phase Power.**

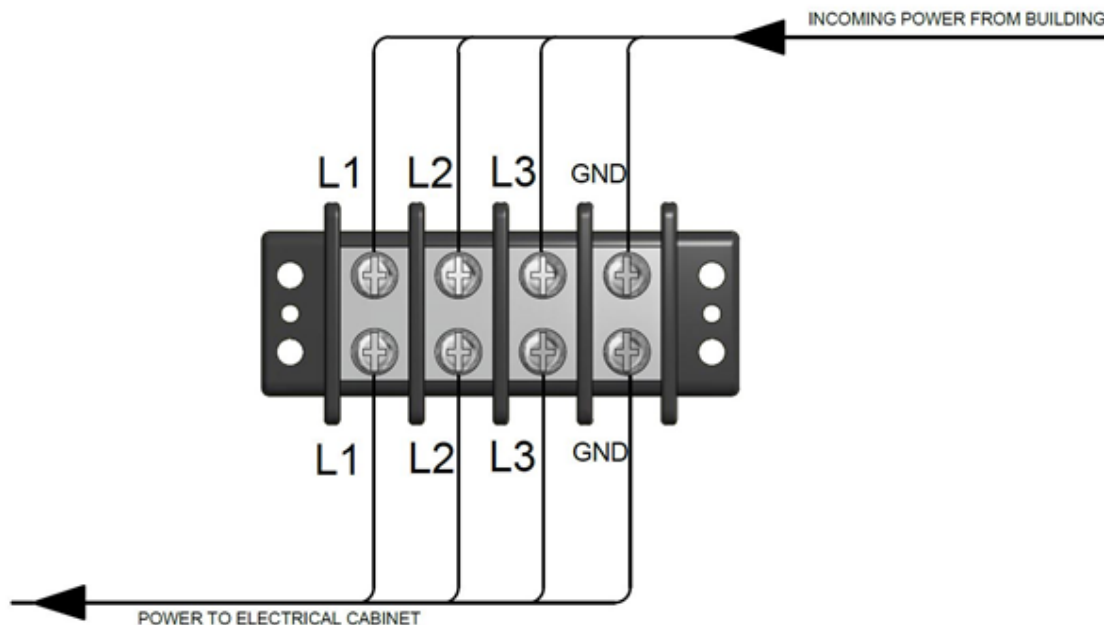

Grounding

The machine requires a good earth ground. The grounding conductor from the incoming power source must be connected to the grounding block located inside of the electrical cabinet. A ground rod installed in addition to the electrical service grounding conductor is permitted but must be connected directly to the grounding block inside of the electrical cabinet. Connecting the ground rod to the machine base is not permitted. Consult a Licensed Electrician in your area to assess the installation and install the appropriate ground rod if necessary. Failure to do so may lead to an installation that is unsafe and does not meet national and local electric codes.

Transformer Connections

This machine has the following minimum transformer size requirement:

- 30 kVA

If a transformer is necessary for machine installation, please refer to the diagram below for connection information. Transformers must be sized to meet the minimum power requirements listed above. Consult a Licensed Electrician in your area for transformer selection and installation.

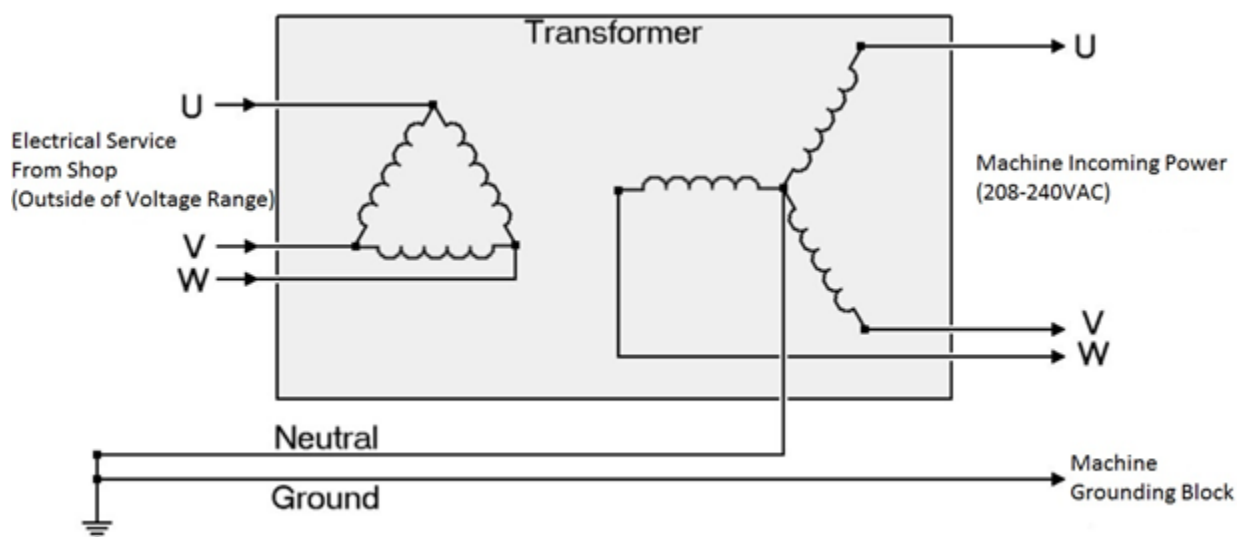

Phase Converters

It is always preferred to provide Three Phase Power directly from the electrical service to the machine. If Three Phase Power is not available in the required installation location, a phase converter may be used to power the machine. A CNC rated phase converter is required for correct operation of the machine. Consult a Licensed Electrician for proper sizing and installation.

Setting Soft Limits for Machine Movements

The soft limits prevent the machine from moving far enough to cause physical contact and possible damage using programmed positions. This setting must be done on initial installation and any time a motor has been replaced.

NOTE: Setting the limits to any values other than those shown below can lead to damage to the machine.

The following steps demonstrate the process for setting the X-Axis soft limit. The process is identical for the Y- and Z-Axis setting.

1. Start the Rottler Block Software
2. Move the machine to the right (up for Z-Axis, to the rear for Y-Axis) until only about 0.200" of the front rail is visible towards the end of the machine (NOTE: it will be necessary to disconnect and pull back the way cover for the X-Axis)
CAUTION: Failure to do this can result in overtravel and damage.
3. From the main screen of the Rottler Block Software, select Setup Electronics → Control. This will bring up the Control Options window.

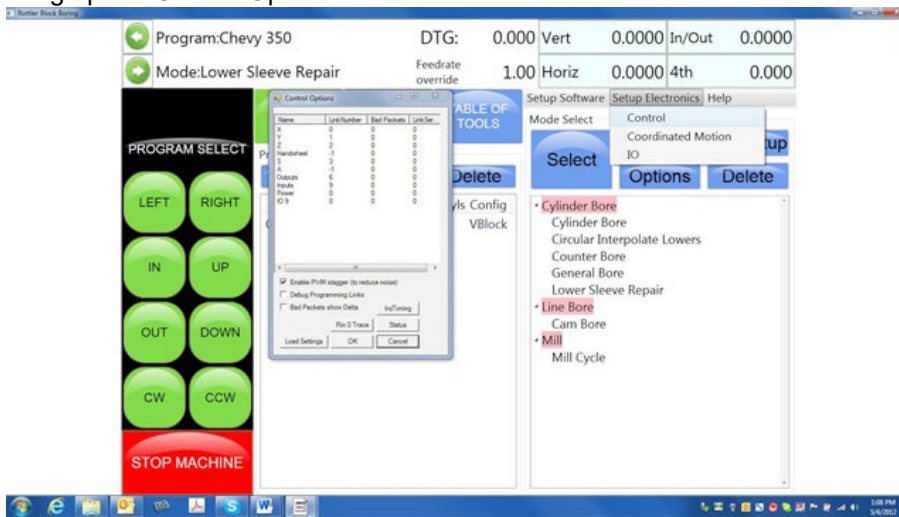

4. Double-click on "X" to open the X-Axis options window
5. Expand the "Limit Setting" arrow
6. Set the "Enable Top Soft Limit" and "Enable Bottom Soft Limit" to "False"
CAUTION: The machine is now capable of over-traveling, do NOT move any axis until this process is complete.

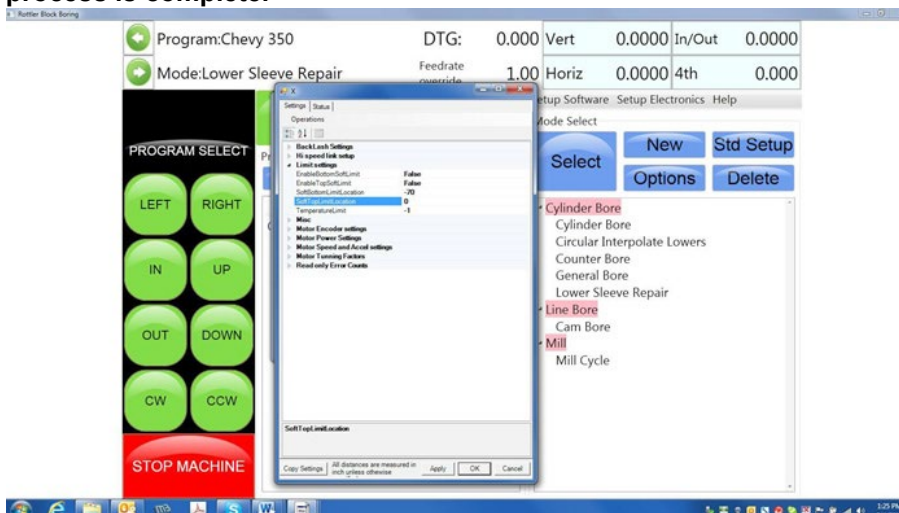

- Set the Bottom Soft limit value according to this table:

Axis	EM103	EM104	EM105
X	-83	-109.8	-134
Y	-16	-16	-16
Z	-29	-29	-29

- Set the “Enable Top Soft Limit” and “Enable Bottom Soft Limit” back to “True”
- Select Operations → Set Home Preset to open a dialog window

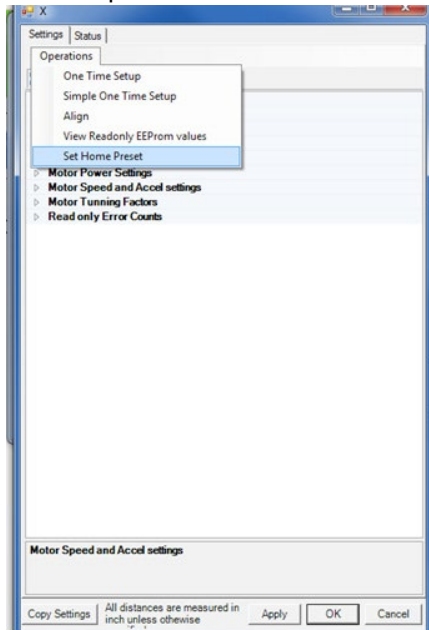

- Type “0” into the input box and press “OK”. This sets the Home position to the current position of the Axis.

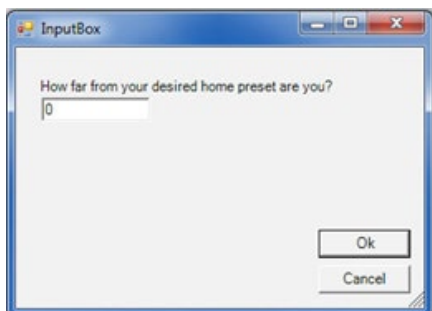

- Close all dialog boxes and windows after setting the limits for each axis
- Select Setup Software → Addins → Line Bore Setup

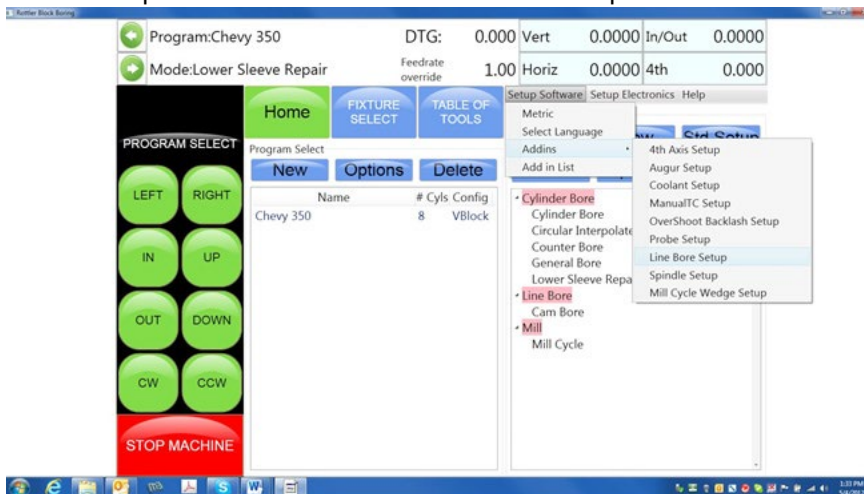

- Expand the Misc arrow in the window that opens

14. Set "Enable Top Secondary Soft Limit" and "Enable Bottom Secondary Soft Limit" to "True"
15. Set the Bottom limit to -17 and the Top limit to -2.5

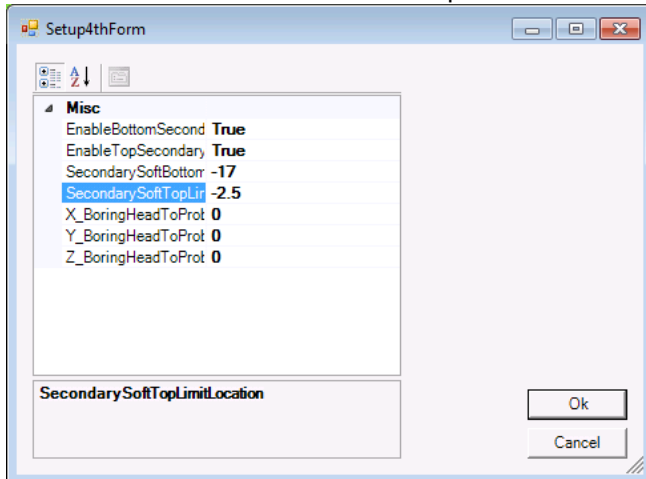

16. Close all dialog boxes. Soft Limits are now fully set.

Creating a Skype Account

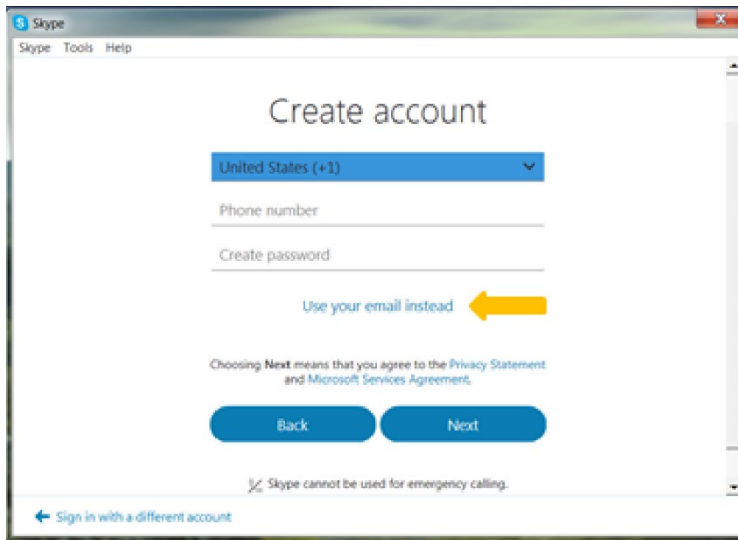

Click on "Create an account"

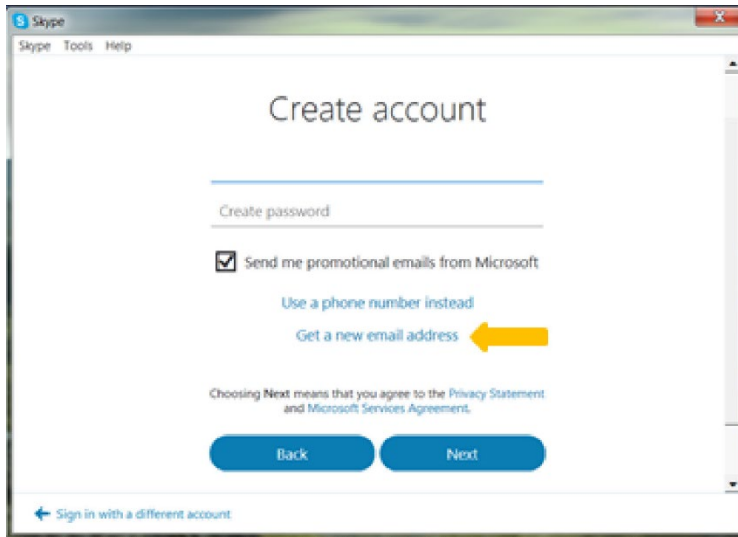

Click on "Use your email instead"

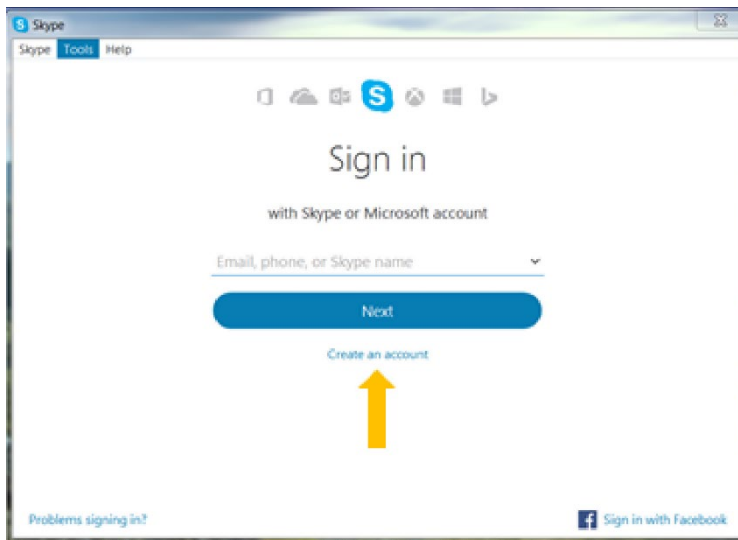

Click on "Get new email address"

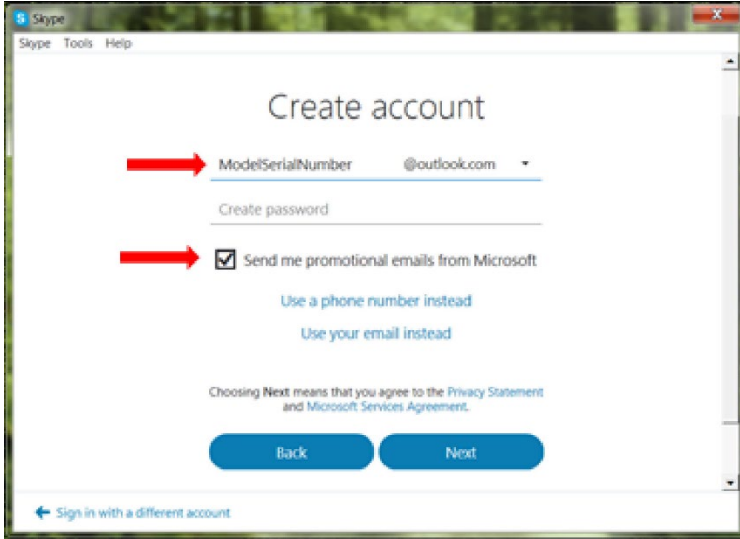

Name the email account using the Rottler machine Model and Serial number.

Ex. H85A111, EM69P001

Create a password that is easy to remember.

Uncheck the box to receive emails from Microsoft.

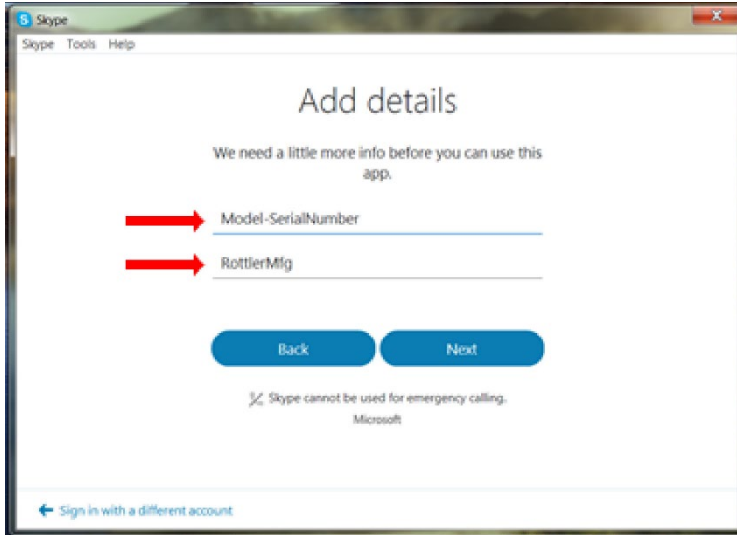

First Name: Model-Serial Number

Ex. EM105-113

Last Name: RottlerMfg

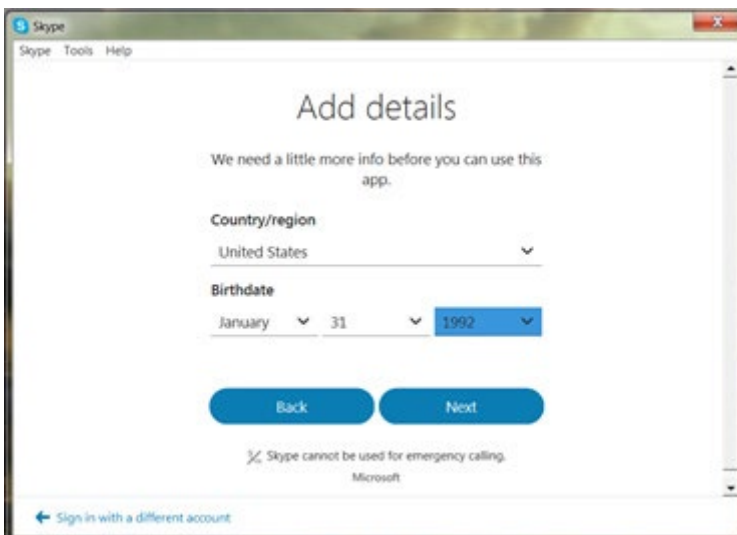

Select your Country/Region

Birthday: Today's Date, 1992