

June 23, 2014



**SG8M**

**SEAT & GUIDE MACHINE**

MACHINE SERIAL NUMBER

---

OPERATIONS AND MAINTENANCE  
MANUAL



MANUFACTURED BY:

ROTTLER MANUFACTURING LLC  
8029 South 200th Street  
Kent Washington 98032  
USA

Phone: (253) 872-7050

Fax: (253) 395-0230

Website: <http://www.rottlermfg.com>

**NOTE:** WHEN ORDERING REPLACEMENT PARTS,  
PLEASE GIVE THE MODEL AND SERIAL NUMBER.  
SEND DIGITAL PHOTO OF PART TO EXPIDITE ORDER.  
ORDER BY PART NUMBER.

**THERE IS A MINIMUM ORDER OF \$25.00**



## **TABLE OF CONTENTS**

<b>Chapter 1</b>	<b>Introduction</b>
<b>Chapter 2</b>	<b>Installation</b>
<b>Chapter 3</b>	<b>Safety</b>
<b>Chapter 4</b>	<b>Control Definition</b>
<b>Chapter 5</b>	<b>Operating Instructions</b>
<b>Chapter 6</b>	<b>Maintenance</b>
<b>Chapter 7</b>	<b>Troubleshooting</b>
<b>Chapter 8</b>	<b>Machine Parts</b>
<b>Chapter 9</b>	<b>Options (located in a separate manual)</b>
<b>Chapter 10</b>	<b>MSDS</b>

**Table of Contents for each chapter are at the beginning of each chapter.**



**⚠ WARNING**

**MACHINE HAZARDS**  
Do not operate this equipment without prior training and instruction. Failure to comply will cause serious injury.

**READ THE SAFETY CHAPTER BEFORE INSTALLING MACHINE. THOUGHERLY UNDERSTAND ALL SAFETY ISSUES BEFORE OPERATING MACHINE.**

**ATTENTION OWNER/BUSINESS MANAGER**

**To validate the warranty on your new Rottler machine, please be sure to sign and complete the “Installation Report” located in the Installation Chapter of this manual.**

We suggest that the new user of the SG8M read the CONTROL DEFINITIONS to get an idea how the machine operates.

The Operating Instructions chapter should be read in order to familiarize the user with the actual button pushing sequences required to carry out a job. These chapters in the manual should be considered an introduction. As the operators of the SG8M series machines gain experience with using the different functions of the machine, complicated setups and programs will make more sense.

The rest of the manual contains information and part number reference on fixtures, cutting tools, and machine maintenance. The operator should read and become familiar with these areas as well.

**Disclaimer**

The SG8M Manual (henceforth to be referred to as the "Manual") is proprietary to Rottler Manufacturing LLC. ("Rottler Manufacturing") and no ownership rights are hereby transferred. No part of the Manual shall be used, reproduced, translated, converted, adapted, stored in a retrieval system, communicated or transmitted by any means, for any commercial purpose, including without limitation, sale, resale, license, rental or lease, without the prior express written consent of Rottler Manufacturing.

Rottler Manufacturing does not make any representations, warranties or guarantees, express or implied, as to the accuracy or completeness of the Manual. Users must be aware that updates and amendments will be made from time to time to the Manual. It is the user's responsibility to determine whether there have been any such updates or amendments. Neither Rottler Manufacturing nor any of its directors, officers, employees or agents shall not be liable in any manner whatsoever to any person for any loss, damage, injury, liability, cost or expense of any nature, including without limitation incidental, special, direct or consequential damages arising out of or in connection with the use of the Manual.

**Limited Warranty**

Rottler Manufacturing Company Model SG8M parts and equipment is warranted as to materials and workmanship. This limited warranty remains in effect for one year from the date of delivery, provided the machine is owned and operated by the original purchaser and is operated and maintained as per the instructions in the manual.

Tools proven to be defective within the warranty period will be repaired or replaced at the factory's option.

The products are warranted upon delivery to conform to their published specifications and to be free from defects in material and workmanship under normal use for a period of one year from shipment. Should a product not be as warranted, Rottler sole obligation shall be, at its option, to repair, correct or replace the product or to refund the amounts paid for the Product upon its return to a location designated by Rottler. No warranty shall extend to rapid wear Products (including tooling) or to Products which have been subject to misuse (including any use contrary to Rottler instructions), neglect, accident (including during shipment), improper handling or installation, or subject to any modification, repair or service not certified by Rottler. Rottler shall not be liable for any consequential, direct or indirect damages or for any other injury or loss. Buyer waives any right, beyond the foregoing warranty, to make a claim against Rottler. No warranty is provided for any Products not paid in full.

Merchandise cannot be returned to Rottler without prior approval. Customer must contact the Order Department or representative to get approval and to be issued a Return Goods Authorization number (**RGR#**). Merchandise authorized for return must be returned prepaid. If merchandise is returned with shipping charges collect, the actual amount of these charges may be deducted from any credit which may be due the customer. The **RGR #** assigned by the Order Department should be written on the shipping label and must appear on a copy of the invoice(s) covering the original shipment. This invoice copy must be included in the box with the parts. Shipment must contain **ONLY** those items on the **RGR** as approved for return. Merchandise must be received within 10 days of the date of **RGR** or the **RGR** will be canceled. All returned merchandise may be subject to a 20% restocking fee on under \$1,000.00 amount or 10% on any items over \$1,000.00. Parts or tooling over 30 days old are considered as customer property and can only be returned with prior written approval from Rottler Corporation Management and/or Shipping Department.

The issuance of a **RGR DOES NOT** guarantee credit - it is only authorization for the return of the goods. Credit for return merchandise is at the sole discretion of Rottler. Credit will be issued only after inspection of returned goods.

Tools proven to be defective within the warranty period will be repaired or replaced at the factory's option. We accept no responsibility for defects caused by external damage, wear, abuse, or misuse, nor do we accept any obligation to provide compensation for direct or indirect costs in connection with cases covered by the warranty.

**Contents**

**ROTTLER SG8M INSTALLATION REPORT ..... 3**

Installation Procedure ..... 7

    Location ..... 7

        Unpacking and Lifting ..... 7

    Positioning the Machine ..... 7

    Removing shipping brackets ..... 8

    Leveling the Machine..... 9

    Air Supply ..... 10

    Air Adjustments ..... 10

        Float ..... 10

    Power Supply ..... 11

        Grounding ..... 11

## **ATTENTION OWNER/BUSINESS MANAGER**

**To validate the warranty on your new Rottler machine, please be sure to sign the installation report after the installation technician has installed the machine and verified the machine is operating correctly and given the operators operation and maintenance training.**

**Thank you for your cooperation and the opportunity to be of service to you.**

**ROTTLER MANUFACTURING**



Route to: Andy  $\longrightarrow$  Machine Packet File  
 SG8M Installation Report Rev 11082013

## ROTTLER SG8M INSTALLATION REPORT

### ROTTLER MANUFACTURING MUST HAVE THIS REPORT RETURNED TO PROPERLY QUALIFY WARRANTY ON EQUIPMENT

Customer: \_\_\_\_\_ Address: \_\_\_\_\_  
 City: \_\_\_\_\_ State: \_\_\_\_\_ Zip: \_\_\_\_\_ Phone: \_\_\_\_\_  
 Machine Model: \_\_\_\_\_ Serial Number: \_\_\_\_\_ Representative: \_\_\_\_\_

**MACHINE INSTALLATION:** Electrical information MUST be complete to validate this report.

Customer is responsible for providing electricity to machine in a manner that meets the local electrical code requirements.

\_\_\_\_\_ BEFORE turning power on to the machine. Check all wires for security by using the correct screw driver and turning CW until movement stops. Stranded wire can "spread" slightly from vibration during transport.

\_\_\_\_\_ Check machine level for equal support on feet.

\_\_\_\_\_ This machine requires between 208 and 240 Volts AC, Single Phase, 50/60 Hz, isolated power supply. Measure the incoming voltage between L1 and L2. Current requirements for this machine are 15 amps. Measure the incoming AC voltage at least twice during installation.

1) \_\_\_\_\_ VAC 2) \_\_\_\_\_ VAC

\_\_\_\_\_ Measure each leg of the incoming supply to ground. On a Delta supply the voltage should be between 100 and 120 VAC each leg to ground. When using a one leg and neutral of a 380 VAC three phase supply L1 should measure 240 VAC and Neutral should measure almost 0 VAC. L1 to ground \_\_\_\_\_ VAC L2 to ground \_\_\_\_\_ VAC.

Make sure all electrical equipment has the proper overload protection. The SG8M should have a **fully isolated** power supply to prevent damage and uncontrolled movement of the machine. If the SG8M is on the same power lines that are running to other electrical equipment (grinders, welders, and other AC motors) electrical noise can be induced into the SG8M electrical system. Electrical noise can cause the controller to see false signals to move.



Neutral and machine ground are not the same thing. You should measure an open circuit between Neutral and ground.



**IF VOLTAGE IS OUTSIDE THE CORRECT RANGE AT ANY TIME THE MACHINE WILL NOT OPERATE PROPERLY AND MAY BE DAMAGED.**

\_\_\_\_\_ Relocate electrical enclosure from shipping location to operating location on lower right side of machine.

\_\_\_\_\_ Air of the proper pressure and capacity connected to the machine. Air supply must be free from oil and water. Oil or water will damage electrical and air components. Air pressure should never drop below 90 PSI at any time. Failure to provide adequate air supply may cause improper floating and clamping.

\_\_\_\_\_ Inspect all wire connections with a screwdriver for security. Stranded wire used in these machines can spread and loosen a connection when shipping.

- \_\_\_\_\_ Remove all shipping brackets in accordance with the machine manual.
- \_\_\_\_\_ Clean any rust inhibitor from the machine surfaces. Slide the spindle base from side to side continually cleaning the machine base until all inhibitor is removed.
- \_\_\_\_\_ Have the operator read through the operation manual before training begins. This will help him be familiar with the button pushing sequences. Have the operator read through the manual again after training and some of the sequences will make more sense.
- \_\_\_\_\_ Calibrate angle sensor

## MACHINE START-UP



When starting the machine for the first time, it may move out of control. Make sure all hands are clear of machine parts. Be ready to press the Emergency Stop button if needed.

- \_\_\_\_\_ Turn main power on from the main incoming breaker box.

## MACHINE MOVEMENTS

- \_\_\_\_\_ Make sure there is nothing obstructing the full vertical travel of the machine.
- \_\_\_\_\_ When the machine is on the clamp mode and the air pressure is with the requirements, tray to move workhead to verify that you have a solid clamp of Work head.
- \_\_\_\_\_ Place the level on the leveling post. The level assembly is referenced to the spindle via the level pin. It is there for important to check alignment of pin in reference to the spindle. Even though the level has been carefully calibrated at the factory, it is a good idea to recheck calibration before putting the machine into service. In the event that the level is dropped or handled roughly then the following recalibration methods should be implemented. If calibration is require refer to manual for Calibrating the Digital Level
- \_\_\_\_\_ Start the spindle and verify operation.

## INSTRUCTING THE OPERATOR:

- \_\_\_\_\_ Using the operating manual as a guide explain the function of all buttons.
  - \_\_\_\_\_ Cycle all machine movements and supervise the handling of same by operator.
  - \_\_\_\_\_ Demonstrate the engaging of the fine feed system.
  - \_\_\_\_\_ Point out safety features to customer and operator.
- Do not push any buttons without thinking of safety first.**



Do not assume the Digital level has been calibrated rotate 180 to verify alignment.

- \_\_\_\_\_ The following is a checklist to go through every time the machine is started to begin machining a seat.
  - Work piece secure
  - RPM set
  - Tool holder adjusted to the correct setting base on the type of seat you will be machining
  - Tool holder locked in place
  - Floating of the Workhead and clamping
- \_\_\_\_\_ Proceed to have operator to machine a seat under you control.
- \_\_\_\_\_ **Parts ordering, refer to the operating manual for part numbers and description.**
- \_\_\_\_\_ Review Emergency stop procedure and with operator per operating manual.

General remarks on machine performance, adjustments as received and any further organization or parts required to complete the set up:

---

---

---

---

---

---

---

---

---

---

---

---

---

---

---

---

---

---

---

---

---

---

Instructions given to: \_\_\_\_\_

Sales/Service Engineer: \_\_\_\_\_ Date \_\_\_\_\_

Shop Foreman/Superintendent or Owner: \_\_\_\_\_ Date \_\_\_\_\_

This page intentionally left blank

## Installation Procedure

### Location

The productivity of the SG8M will depend a great deal on the proper initial installation. Pay particular attention to the means by which work pieces are lifted into and out of the machine as well as the material handling to and from other operations in your shop. The proper loading arrangements and work location for your SG8M is extremely important.

For shops where large production runs are anticipated, the work pieces should be loaded and unloaded directly from a conveyer. If this is not the case, we suggest you pay considerable attention to the crane so that it covers an adequate area to allow the operator to back up and remove work pieces without creating a cluttered, dangerous work area.

### Unpacking and Lifting

Use care when removing the crate materials from the machine. Be careful not to use force on any part of the machine.

Remove the shipping screws (4) from the skid; the shipping brackets will be painted red for easy identification. These screws are located at the four bottom corners of the Main Base.

### CAUTION

THIS MACHINE IS TOP-HEAVY. Use care when lifting and moving Machine. Approximate shipping Weight of Machine is 2800 lbs. (1258 kg).

### Positioning the Machine

#### **WARNING**

Lift Machine using a fork lift. Move fork lift to front of Machine and separate forks so they are visually centered. Insert forks under front-center of Machine, using care not to damage Foot Pedals Valve or Air Lines. Tilt forks slightly upward so Machine will lean toward fork lift and lift Machine.

While Machine is on fork lift, install five (6) Leveling Screws and Jam Nuts in holes provided in bottom of Machine Base. Two (2) Screws installed in rear-corners and one (2) Screw installed in front and rear - center of Machine Base will serve as Leveling Screws; while two (2) Screws installed in front-corners of Machine Base will serve only as Support Screws.

Move Machine to desired location and placed leveling bolts over the center hole of the Leveling Pad. Be certain to allow sufficient clearance to allow access for leveling and also for connecting air and electrical lines. Lower machine onto leveling pads making certain that the leveling bolts align into counterbore on leveling pads.

Be certain nothing interferes with air or electrical lines running from the floating head assembly to the cabinet. Determine there is no possibility of air or electrical lines dragging on wall surfaces or adjacent machinery.

Wipe top Rails with a clean, dry cloth to remove protective shipping oil.

### CAUTION

Do not attempt to move the Work Head unless Air Supply is connected, and air valve is turned on, and foot Pedal is depressed, allowing Head to float on Rails apply (WD40) or similar degreaser and flow the work Head side by side to remove all the shipping oil from under the work head. (Top Upper surfaces rails should be clean and free of oil).

### CAUTION

Do not attempt to move the Work Head unless Air Supply is connected, and air valve is turned on, and foot Pedal is depressed, allowing Head to float on Rails apply (WD40) or similar degreaser and flow the work Head side by side to remove all the shipping oil from under the work head. (Top Upper surfaces rails should be clean and free of oil).

### Removing shipping brackets

Before leveling the machine, loosen and remove the all shipping brackets and bolts. (Figures 1 – 5)

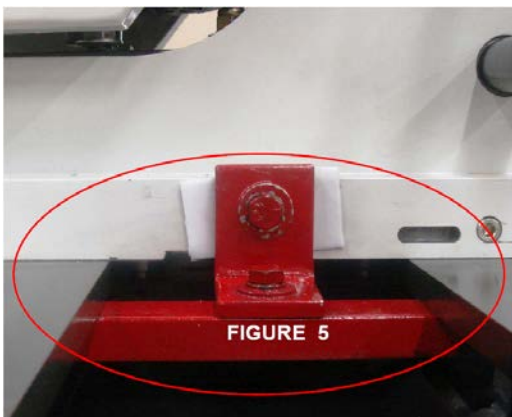
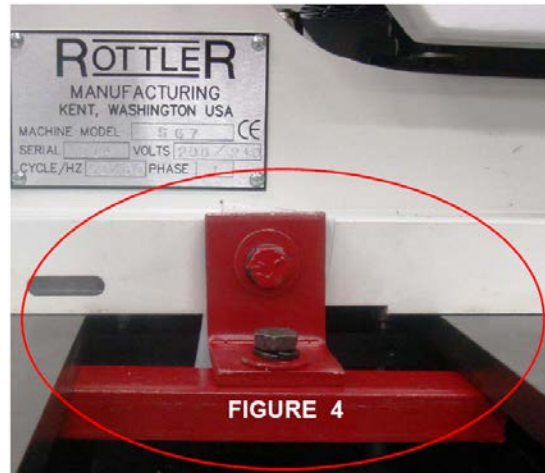
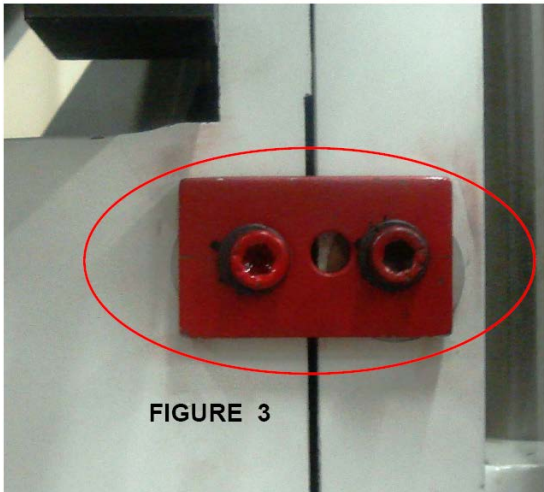
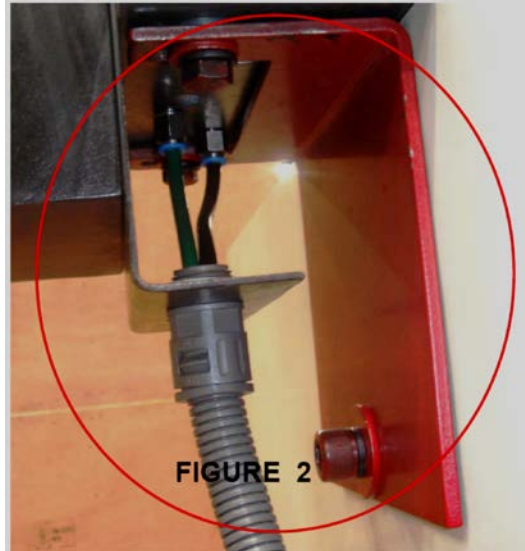
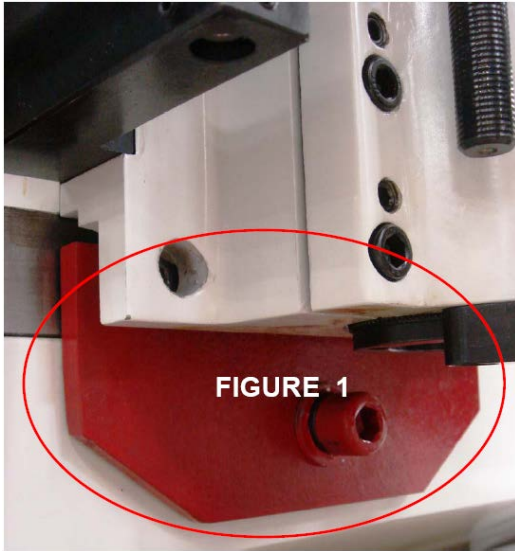

## Leveling the Machine

Use required machinist level. (Starret 98 or better).

NOTE: Rotate Level 180° to check that Level is properly adjusted. If Level does not read same in both directions, recalibrate level.



Use the level on the upper float surface, level the machine as precisely as possible, front to back and side to side.

Adjust 4 corners until level and then extend the 2 center leveling bolts to support machine. Tighten jam nuts on leveling bolts and recheck level



## Air Supply

It is very important the air source for the SG8M machine be moisture free. Water and oil in the line will result in early cylinder and valve failure. The factory recommends installing a water trap at the machine. Attach a 100 P.S.I. air source to the appropriate intake pictured, located on the right rear of the machine near the bottom.



## Air Adjustments

### Float

The float regulator is located to the right of the main regulator.

If the machine is not floating properly, it could be from too much or too little air from the regulator. Turn the regulator all the way off (full counter clockwise). Start turning the regulator slowly clockwise while continually checking the Work Head for proper floatation. Once the correct float is established, lock the regulator into place by pushing in on the blue adjusting knob.

---

**CAUTION** Use as little air as possible to achieve correct floatation. . Using too much air will / could cause excessive movement of workhead.

---



## Power Supply

This machine has the following power requirements:  
 208 to 240 VAC not to exceed 240 Volts  
 Single Phase  
 50 or 60 Hertz  
 15 amps

See illustration below for correct connection of “measured” incoming power. Connect single phase wiring to the main rear enclosure, located on the right rear of machine base. The connection point for power is located inside the enclosure. The connection termination point is the power switch. Connect L1 to the number 2 terminal, L2 (neutral) to the number 4 terminal

### **Important:**

Electrically connect in accordance with national and local electrical codes.

### **Grounding**

This machine must be connected to a good earth ground rod. A 6 foot, ½” diameter, 15 OHM, Copper grounding rod driven into the earth next to the machines is preferred. Not providing a grounding rod could void factory warranty.

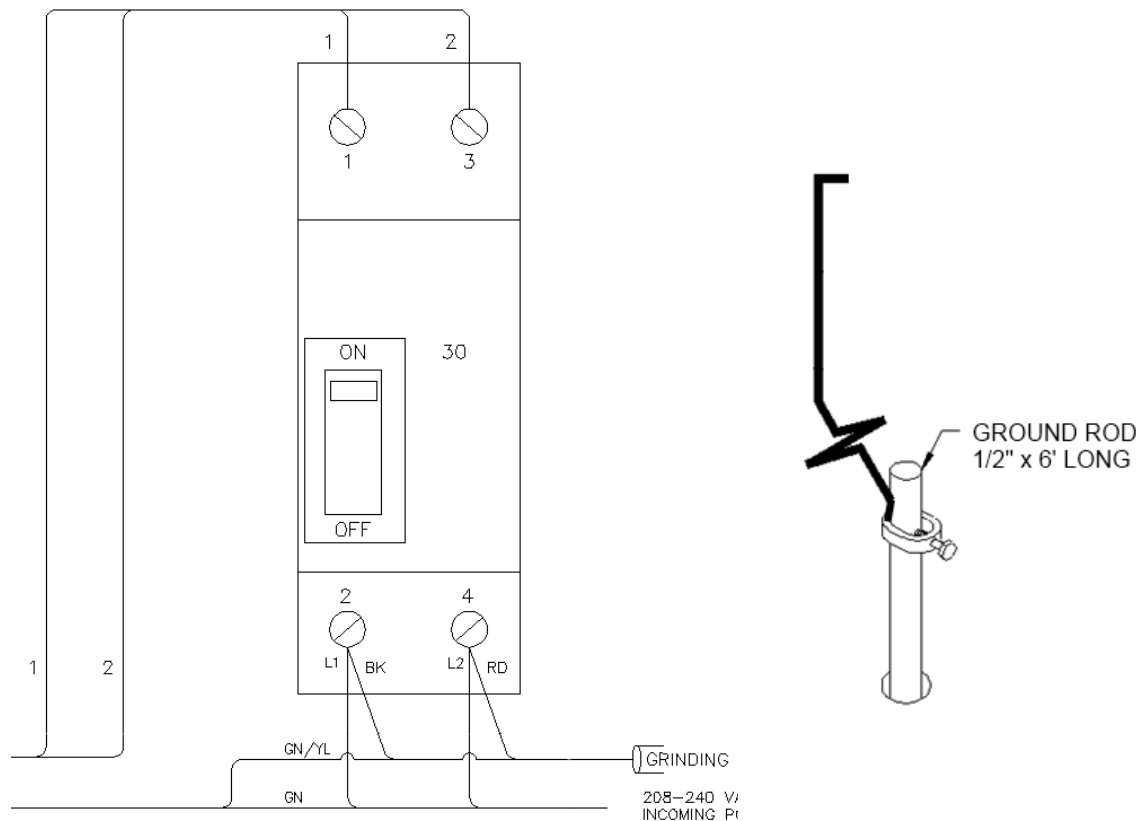

This page intentionally left blank

## Contents

Safety Information .....	2
Safety Instructions for Machine Use.....	2
Electrical Power .....	3
Machine Operator .....	4
Eye Safety:.....	4
Work Area: .....	5
Overreach: .....	5
Hand Safety: .....	5
Machine Capacity: .....	5
Avoid Accidental Starting: .....	5
Careless Acts: .....	5
Job Completion: .....	5
Replacement Parts: .....	5
Misuse:.....	5
Emergency Procedure .....	6

## Safety Information



For Your Own Safety Read This Instruction Manual Before Operating This Machine.



This is the safety alert symbol. It is used to alert you to potential personal injury hazards. Obey all safety messages that follow this symbol to avoid possible injury or death.



DANGER indicates an imminently hazardous situation which, if not avoided, will result in death or serious injury.



WARNING indicates a potentially hazardous situation which, if not avoided, could result in death or serious injury.



CAUTION indicates a potentially hazardous situation which, if not avoided, may result in minor or moderate injury.



CAUTION used without the safety alert symbol indicates a potentially hazardous situation which, if not avoided, may result in property damage.



This machine is capable of causing severe bodily injury.

## Safety Instructions for Machine Use

**ONLY A QUALIFIED, EXPERIENCED OPERATOR SHOULD OPERATE THIS MACHINE. NEVER ALLOW UNSUPERVISED OR UNTRAINED PERSONNEL TO OPERATE THE MACHINE.** Make sure any instructions you give in regards to machine operation are approved, correct, safe, and clearly understood.

**KEEP GUARDS IN PLACE** and in proper working order.

**KEEP WORK AREA CLEAN.** Cluttered areas and benches invite accidents.

**KEEP CHILDREN AND VISITORS AWAY.** All children and visitors should be kept a safe distance from work area.

**WEAR THE PROPER APPAREL. DO NOT** wear loose clothing, gloves, rings, bracelets, or other jewelry which may get caught in moving parts. Non-Slip foot wear is recommended. Wear protective hair covering to contain long hair.

**ALWAYS USE SAFETY GLASSES.** Also use face or dust mask if cutting operation is dusty. Everyday eye glasses only have impact resistant lenses, they are NOT safety glasses.

**DO NOT OVER-REACH.** Keep proper footing and balance at all times.

**USE THE RECOMMENDED ACCESSORIES.** Consult the manual for recommended accessories. The use of improper accessories may cause risk of injury.

**CHECK DAMAGED PARTS.** Before further use of the machine, a guard or other part that is damaged should be checked to determine that it will operate properly and perform its intended function. Check for alignment of moving parts, breakage of parts, mounting, and other conditions that may affect its operation. A guard or other part that is damaged should be properly repaired or replaced.

**NEVER OPERATE A MACHINE WHEN TIRED, OR UNDER THE INFLUENCE OF DRUGS OR ALCOHOL.** Full mental alertness is required at all times when running a machine.

**IF AT ANY TIME YOU ARE EXPERIENCING DIFFICULTIES** performing the intended operation, stop using the machine! Then contact our service department or ask a qualified expert how the operation should be performed.



No list of safety guidelines can be complete. Every shop environment is different. Always consider safety first, as it applies to your individual working conditions. Use this and other machinery with caution and respect. Failure to follow guidelines could result in serious personal injury, damage to equipment or poor work results.

## Electrical Power

Make sure all electrical equipment has the proper overload protection. The SG8M should have **a fully isolated** power supply to prevent damage and uncontrolled movement of the machine.

If the SG8M is on the same power lines that are running to other electrical equipment (grinders, welders, and other AC motors) electrical noise can be induced into the SG8M electrical system.

Electrical noise can cause the controller to see false signals to move. Not supplying a fully isolated supply to the machine may void factory warranty.



All electrical power should be removed from the machine before opening the rear electrical enclosure. It is recommended that the machine have a electrical LOCK-OUT device installed.



Electrocution or a fire can result if the machine is not grounded correctly. Make sure the ground is connected in accordance with this manual. DO NOT operate the machine if it is not grounded. In the event of an electrical short, grounding reduces the risk of electric shock by providing a path of least resistance to disperse electric current.



When you doing any operation on the cylinder head; the machine is capable of throwing metal chips. Eye protection must be worn at all times by the operator and all other personnel in the area of the machine.



The operator and nearby personnel should be familiar with the location and operation of the Emergency Stop Button.



No single list of electrical guidelines can be comprehensive for all shop environments. Operating this machinery may require additional electrical upgrades specific to your shop environment. It is your responsibility to make sure your electrical system comply with all local codes and ordinances.

## Machine Operator

The operator of the SG8M should be a skilled machinist craftsman who is well versed in the caution, care, and knowledge required to safely operate metal cutting tools.

If the operator is not a skilled machinist he/she must pay strict attention to the Operating Instructions outlined in this manual, and get instruction from a qualified machinist in both production and operation of this machine.

The SG8M machines have the following areas of exposed moving parts that you must train yourself to respect and stay away from when they are in motion:



**Cutting Tool Area** – Any operation involving hands in the tool holder, such as inspection or alignment of the tool holder or tools, changing tool holder or insert holders, tool insertion, and removal, tool holder changes, and size checking etc. requires the machine to be in neutral or on the off position.



**Machining** – Eye protection must be worn during all operations of the machine. Hands must be kept completely away from the cutter head.



**Work Loading and Unloading** – Carefully develop handling methods of loading and unloading work pieces so that no injury can result if hoist equipment or lift connection should fail. Periodically check lift components for damage that may cause failure of Cylinder head Handler Assembly.



Machine Maintenance – Any machine adjustment, maintenance or parts replacement absolutely requires a complete power disconnection from the machine, **this is an absolute rule.**

### Eye Safety:

Wear an approved safety face shield, goggles or safety glasses to protect eyes when operating the machine.

**Work Area:**

Keep the floor around the machine clean and free of tools, tooling, stock scrap and other foreign material and oil, grease or coolant to minimize the danger of tripping or slipping. Rottler recommends the use of anti-skid floor strips on the floor area where the operator normally stands and that each machine's work area be marked off. Make certain the work area is well lighted and ventilated. Provide for adequate workspace around the machine.

**Overreach:**

Maintain a balanced stance and keep your body under control at all times.

**Hand Safety:**

NEVER wear gloves while operating this machine.

**Machine Capacity:**

Do not attempt to use the machine beyond its stated capacity or operations. This type use will reduce the productive life of the machine and could cause the breakage of parts, which could result in personal injury.

**Avoid Accidental Starting:**

Make certain the main switch is in the OFF position before connecting power to the machine.

**Careless Acts:**

Give the work you are doing your undivided attention. Looking around, carrying on a conversation and horseplay are careless acts that can result in serious injury.

**Job Completion:**

If the operation is complete, the machine should be emptied and the work area cleaned.

**Replacement Parts:**

Use only Rottler replacement parts and accessories; otherwise, warranty will be null and void.

**Misuse:**

Do not use the machine for other than its intended use. If used for other purposes, Rottler Manufacturing disclaims any real or implied warranty and holds itself harmless for any injury or loss that may result from such use.

## Emergency Procedure

Assuming one of the following has occurred: tool bit set completely off size, work piece or spindle base not clamped, spindle is not properly centered, and these mistakes will become obvious the minute the cut starts

**PRESS THE EMERGENCY STOP BUTTON** (on the front control panel) **IMMEDIATELY!**

Find out what the problem is; return the spindle to its up position without causing more damage. To restart the machine, turn the Emergency Stop Button CW until the button pops out. Make sure the button has been depress for at least 1 ½ minutes or the drive will not have time to reset and they will not function.

Be alert to quickly stop the machine in the event of a serious disruption of the boring process either at the top or bottom of the bores.

**“REMEMBER”** metal cutting tools have the speed and torque to severely injure any part of the human body exposed to them.



# Control Definitions

## SG8 Control Definitions

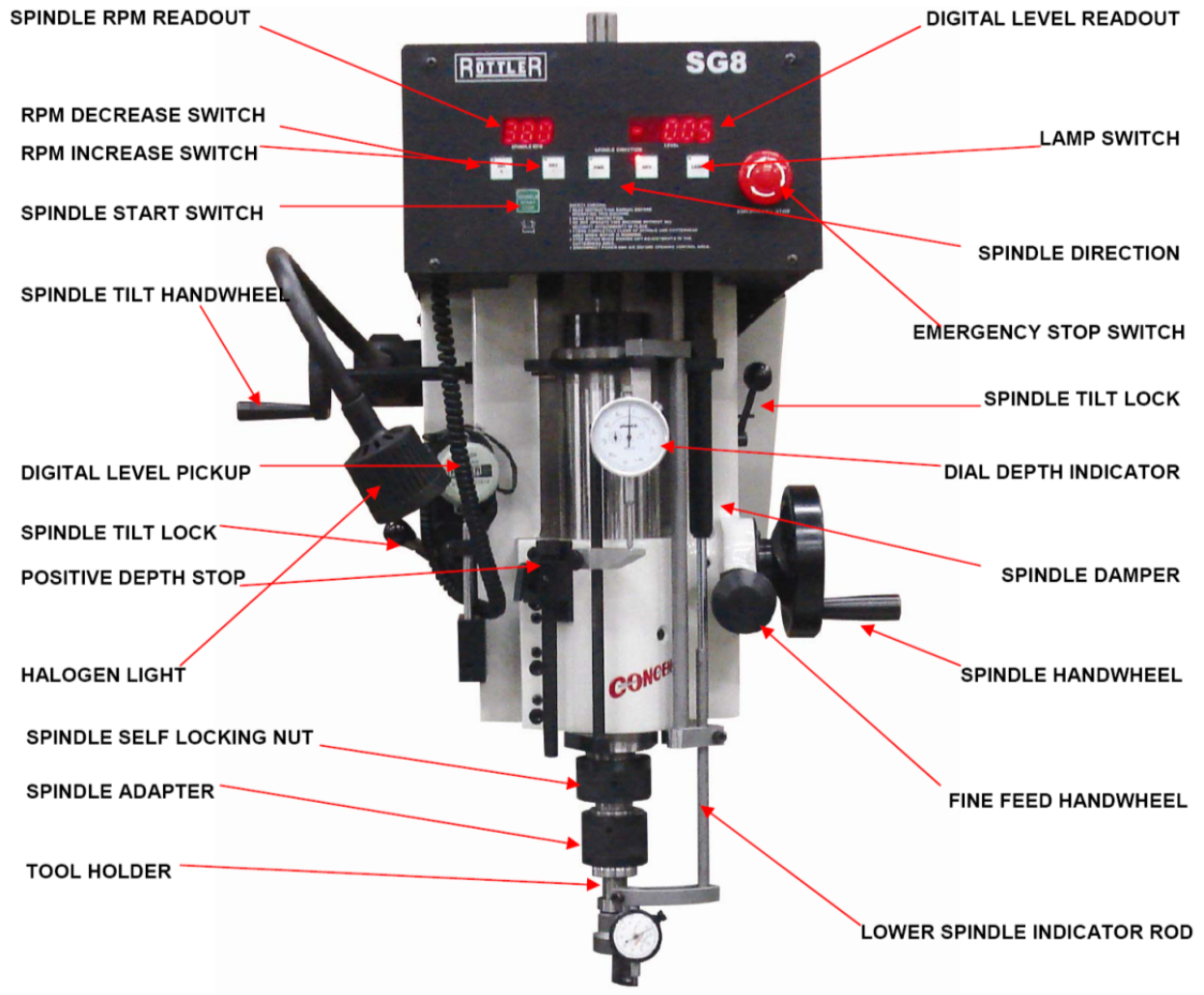

This page intentionally left blank

## Contents

Operating Instructions .....	2
Mounting Tool Sharpener:.....	2
Rottler Tool Bit Sharpener .....	2
Built In Venturi Vacuum Tester:.....	2
Mounting Cylinder Heads:.....	3
360 Degree Rollover Fixtures.....	3
Overhead Cam C Clamp System .....	4
Alignment and Setup: .....	6
Front to Rear Cylinder Head Alignment: .....	6
Left to Right Alignment: .....	7
Canted Valve Cylinder heads (Automotive Application).....	7
Three Angle Seat Cutting: .....	8
Checking Valve Seat Concentricity .....	9
Machining valve seats and Counter Boring:.....	10
Aligning Spindle to Work:.....	10
Changing the Spindle Adapters: .....	10
Installing the Spherical self Aligning Toolholder: .....	10
Fine Feed Engagement: .....	10
Rottler SG8M, SG9M, SG80M Control Panel .....	11
Safety Tips Before Machining: .....	11
Operation Tips before Machining Valve Seats:.....	12
SEAT MACHINING SUGGESTED RPM CHART .....	12
Valve Seat Machining Procedure .....	12
UNIPILOT Centralizing Pilots.....	13
Pilot Diameter .....	13
Shank Diameter.....	13
Extended Length (EL) Pilots.....	13
Modular Carbide Centralizing Pilot System for Valve Guides Over 0.875" (22.23mm) .....	14
Rottler Six and One Instructions .....	15
Adjusting the Square Carbide Inserts:.....	18

## Operating Instructions

### Mounting Tool Sharpener:

Mount tool sharpener on right hand side of machine using the cap screw provided with machine.

### Rottler Tool Bit Sharpener

When you sharpen the Rottler form Carbide bits, consists in restoring the tool cutting angle by grinding the face.

To sharp the carbide bit must be fitted on the bit holder also fitted on the tool holder.

The tool holder will be placed on the adjustable 3/8 fixture of the tool sharpener.

Slide the tool holder on the fixture, and release the adjusting knob.

Adjust the fixture to bring the carbide bit flat against the grinding wheel.

Make sure the carbide tip face is perfectly parallel to the wheel face by pushing it with the thumb. Once a good setting is achieved, lock the adjusting knob.

Before to start the grinding motor, move the carbide bit away from the wheel by rotating the tool holder. The motor should then be started and the carbide tip face will just be cleaned.

There is no need to remove a lot of stock from the carbide bit. Sharpening only consists in providing a new cutting face.



### Built In Venturi Vacuum Tester:

Designed to test valve seat and seat surface seal, and particularly to measure the valve seat surface quality after machining. Including a set of 7 pads and connecting extension.



## Mounting Cylinder Heads:

### 360 Degree Rollover Fixtures

Initial clamp height adjustments to the head trunions can be accomplished by measuring the head thickness then raising the turning clamping block assembly to the appropriate height using the clamping block acme screws. A 10mm T-handle allen wrench works well.

Measure the length of the cylinder head. Spread the trunion assemblies apart from each other so that the cylinder head can be clamped in between the trunions.

Each support has an adjustable stop, located to the front. The stops have indents, allowing a number of different settings. Position of the stops must be checked for each cylinder head put on the supports. In most cases we will install the cylinder head deck side down with the exhaust side of the head against the adjustable stops. This is particularly true of wedge style heads. It is necessary for the clamps to thrust the cylinder head against the stops when clamped. When heads are mounted in this fashion, the tallest portion of the combustion chamber will be at the rear of the machine when the head is rotated into the working position. Try to keep the valve guide center line parallel to the trunion centerline. (Figure 4)

**FIGURE 4**

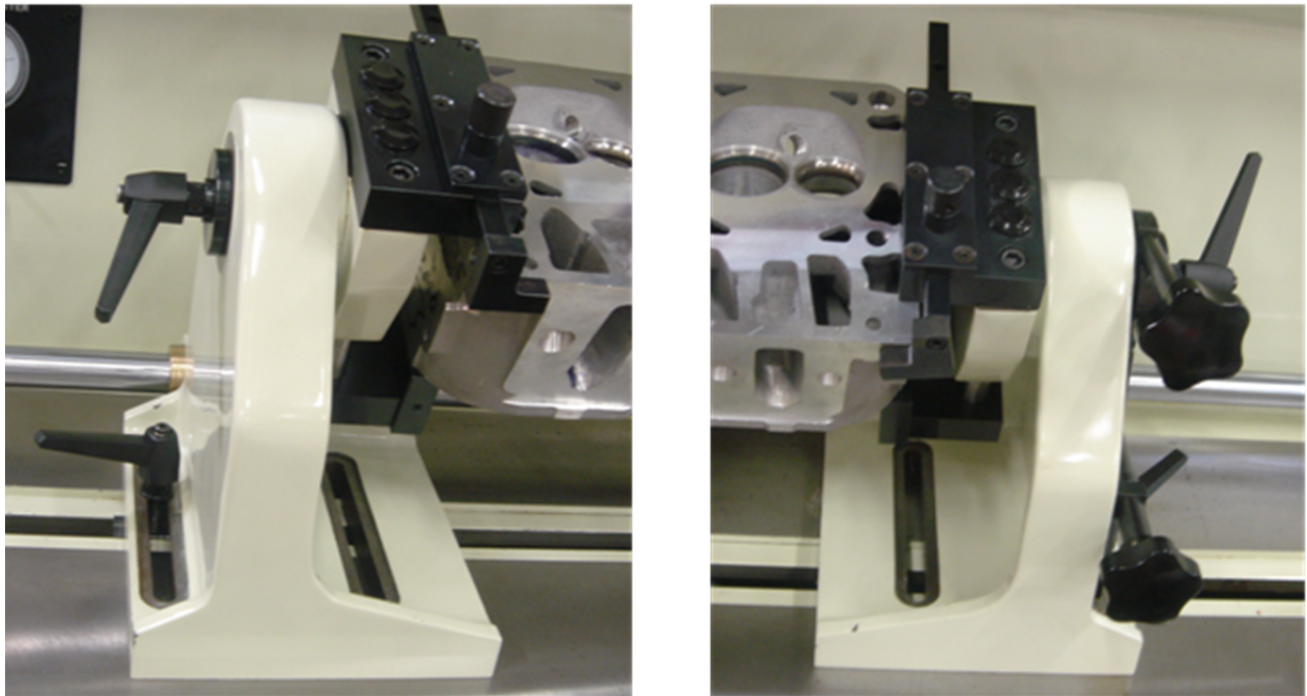

Utilize the grooves in the table to align the trunion supports square to the machine.

### Overhead Cam C Clamp System

Using 10mm Allen wrench, remove the existing lower fixed plate on the 360 degree fixture (left and right)

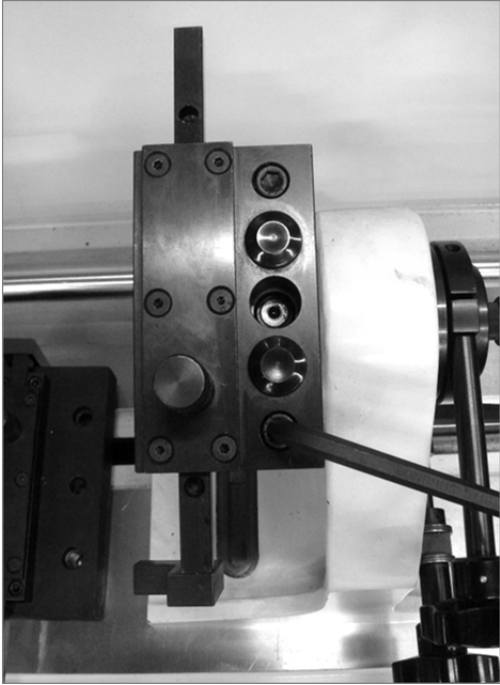

Install the C Clamp, you must use the two bolts included with the fixture and make sure is good and tight

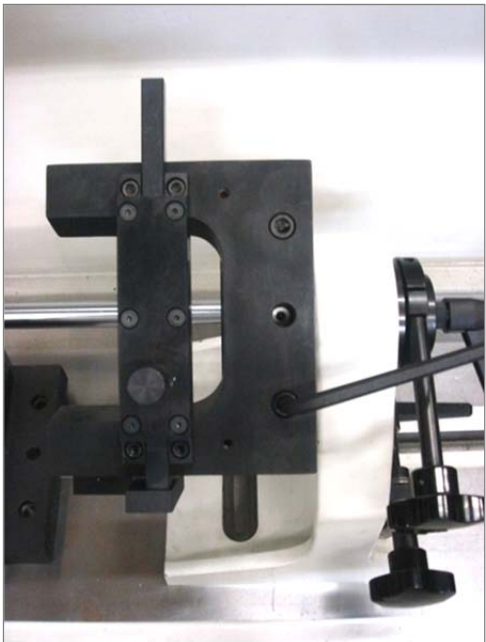

The cylinder head gasket surface must be against the machined surface of the U Clamp Fixture; Slide the stopper rod equally and push the cylinder heads against the stopper rods.

**Note:** for some cylinder heads, you may need a spacer against between the cylinder head and the stopper rod (not included)

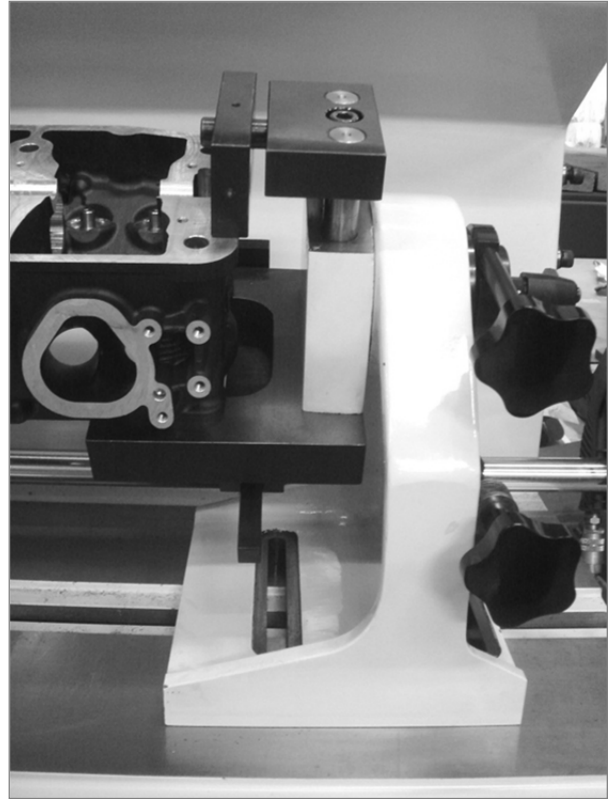
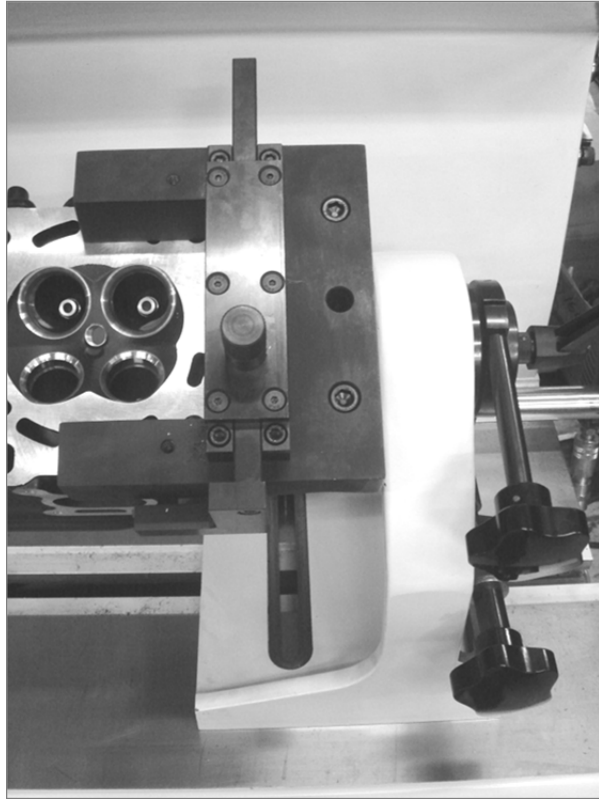

The Quick-Clamp frame is mounted between the trunions and clamped using the clamping plates. (See Pictures) The cylinder head is then held to the frame with the swivel clamp assemblies through the appropriate head bolt holes or used the standard clamp plates.

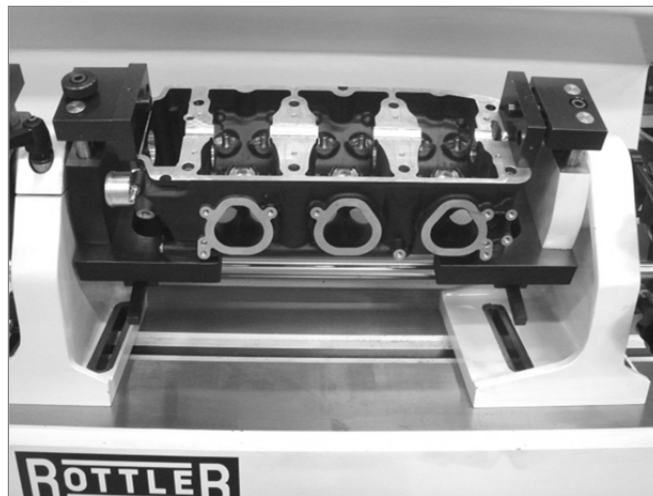

On This cylinder head they using both C frames

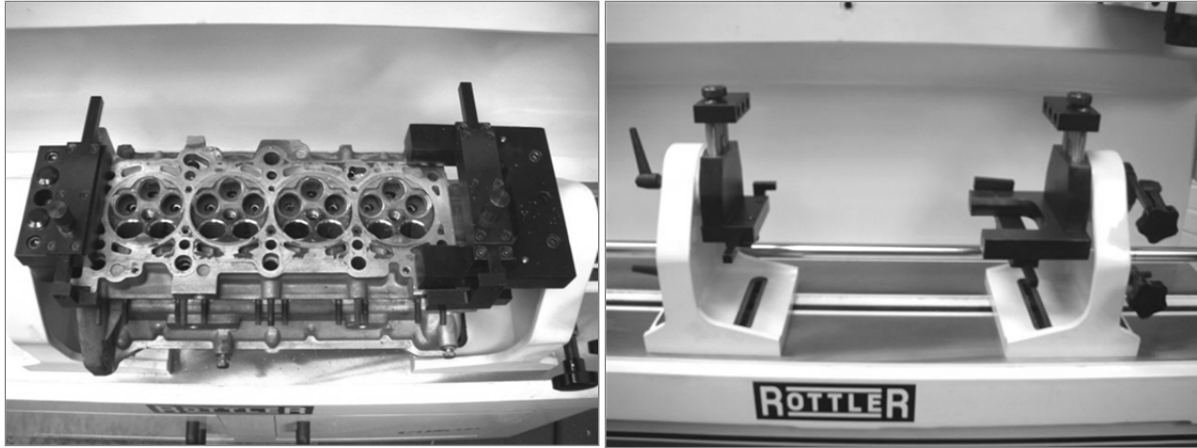

### Alignment and Setup:

Alignment and setup applies to both the cylinder head and the machine's floating head. The goal is to get perfectly align to the spindle centerline of the area of the head to be machined. Most machining operations on cylinder heads use the valve guide centerline as the reference point so we will use that as an example.

**Note: think of the digital electronic level as a comparator. Because the leveling pin is square to the machines spindle, as long as you achieve the same readings front to rear and side to side then the spindle will be in perfect alignment.**

### Front to Rear Cylinder Head Alignment:

Position the level on level pin to read front to rear and take a reading. Rotate the cylinder head so that the valve seats are facing up. Now place the level on a pilot in the cylinder head and position the level to read front to rear. Loosen the lock levers on the supports. Be certain the fine adjustment lock screw is loosened. Coarse adjustment is made by turning the work piece manually, until the level reading is within a couple of degrees of the reading on the leveling post.





Lightly tighten the lock levers on the supports to remove any play. Now tighten the clamp on the fine adjustment screw. Turn the adjustment knob to achieve the exact reading that was observed on the leveling post. You can now completely tighten both the left and right support locks.

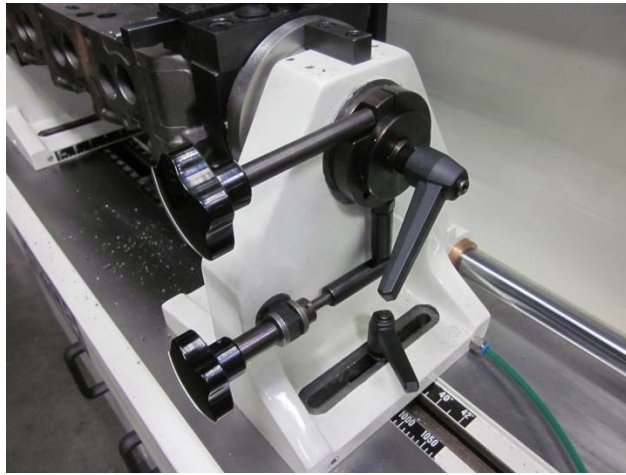

### Left to Right Alignment:

Obtain the left to right reading from a pilot mounted in a guide in the cylinder head. Now place the level on the leveling post. Loosen both of the tilt lock levers on each side of the quill housing. Use the tilt adjusting hand wheel to adjust the reading to be the same as that found on the pilot in the cylinder head. Tighten the tilt lock levers.



### Canted Valve Cylinder heads (Automotive Application)

An optional alignment bar is available that helps establish the front to back alignment on canted valve cylinder heads. The bar is held against two pilots in two adjacent guides. Use the alignment post to adjust the angle. (See Picture)



### Three Angle Seat Cutting:

Place the ball drive adapter in the spindle.  
Align spindle to valve guide.

Place a valve in the setting fixture. Position the pointer on the valve where you wish to place the top of the seat.

Remove the valve; replace it with the correct pilot.

Select the proper diameter tool holder. Place the carbide insert in tool holder. Slide tool holder onto ball head.

Place ball head over the pilot in setting fixture. Use radial adjusting screw to set diameter of cutter to correspond to position of pointer on setting fixture.

Tighten hex socket screws on bottom of ball head. See figure 9

Remove ball head assembly from setting fixture. Place fixed carbide pilot in cylinder head.  
Center the spherical ball head tool holder over the pilot shank.

Required spindle rotation speed will vary, depending on seat hardness. As seat hardness increases, so does the required spindle speed. Some will require full speed.

Special care should be taken in centering the floating head above the valve guide, to achieve a concentric seat.  
Cut seat only enough to clean up surface.

Too much cutting will sink the valve too far in the head. Many operators prefer to use the spindle fine feed when machining seats as extreme control of spindle down feed can be accomplished.

The capacity of the Rottler SG7 / SG8M / SG9M / SG10A associated with a complete tooling range allow working on seats of diameters between 14 and 120 millimeters (0.55"- 4.7").

Three tooling ranges are possible:

❶ For seats diameters between 14 and 25 mm ( 0.55"- 1"): tool holder BH600R1 and Mini tip holder TH1999 for seat range .551" - .984" (14mm-25mm) with pilots with 6.00mm shank diameter.

❷ For seats diameters between 18 and 60 mm ( 0.71"- 2.4"): tool holder BH375R1, or UPT5100 (SG10A,9M only) and tip holder TH2000 for seat range .710" - 1.180" (18mm-30mm) or TH2001 for seat range 1.100" - 1.570" (28mm-42mm) or TH2002 for seat range 1.570" - 2.360" (40mm-60mm), with 9,52 mm ( 3/8 ") pilots of shank diameter

❸ For seats diameters between 40 and 80 mm (1,570" - 3.150"): tool holder BH375WR1 or UPT5300 (SG10A,9M only) and tip holder TH2003 for seat range . 1.570" - 2.360" (40mm - 60mm) or TH2004 for seat range 2.280" - 3.150" (58mm - 80mm), with pilots with 9,52 mm ( 3/8 ") shank diameter.

**IMPORTANT:** When the form tips, the square tips or the triangle inserts are fitted, check that their reference faces are perfectly clean.

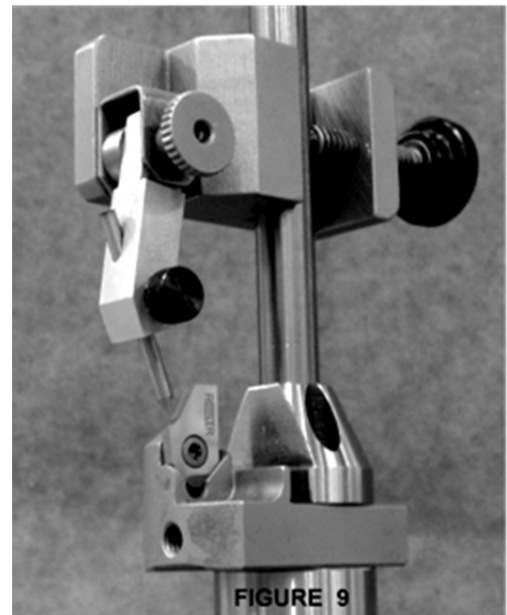
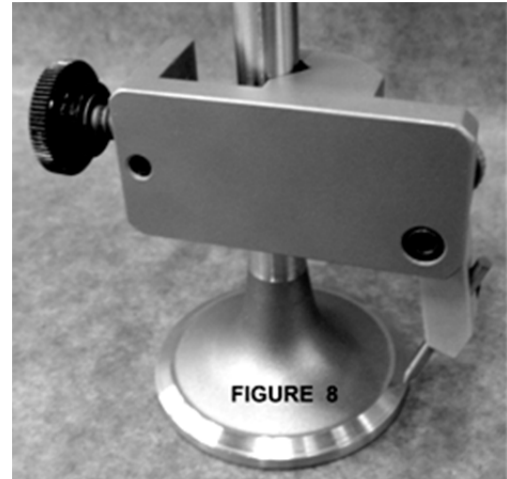

## Checking Valve Seat Concentricity

Make sure pilot and valve seat to be measured are free from dust, burrs, etc. A drop of oil or similar lubricant on valve seat will aid measuring. Loosen brass locking screw and lower dial gauge down over pilot. Make certain the tip of the probe is centered on the valve seat to be inspected.

Grasp brass frame in middle of gauge and move upward approximately 1/8". The dial pointer should move as this is done. Center the pointer of the indicator pointing upward and lock the gauge to the pilot using the brass locking screw. Test proper alignment by moving the brass frame up and down. The pointer should move.

Set the pointer at (0) by turning the dial face.

Inspect the seat run out by rotating the probe around the valve seat by twisting the knurled sleeve with your fingers. Each number on the dial indicator is equal to 0.001", (0.0254mm) run out of the valve seat. Each mark on the dial indicator is equal to 0.0001", (0.00254mm) run out of the valve seat.

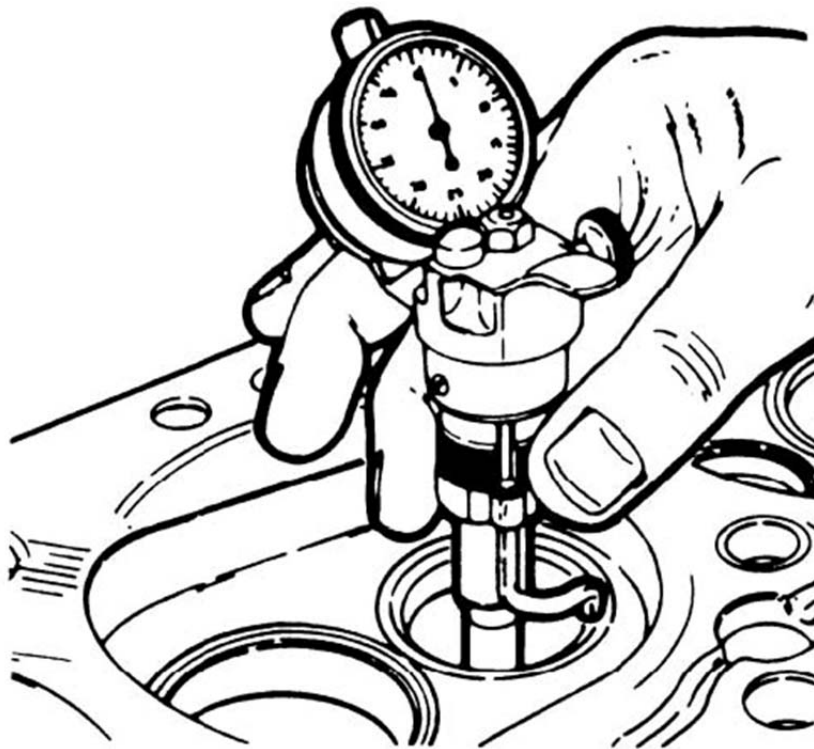

## Machining valve seats and Counter Boring:

### Aligning Spindle to Work:

Most machining operations require the spindle to be directly centered over the work to be performed. This is usually accomplished by air floating the work head above the area to be machined then manually lowering the spindle to engage the tooling that's going to be used. Most of the tooling used with the SG9M has been engineered with this centering feature incorporated into the design

**CAUTION** If the pedal is released too quickly, the floating head may bounce. True centering may not be achieved, if this happens. Slowly releasing the air float pedal gives the best results. Removing your hands completely from the work head during the final seconds of centering will insure that you do not negatively influence centering accuracy.

### Changing the Spindle Adapters:

Once that you have the tool holder setup, fit the ball head tool holder into the spring free spindle adapter.

The SG8M spindle has been engineered to allow ultra-fast tooling changes.

Make sure the spindle spring free locking nut is in the off lock position, line up the two ears of the spindle adapter and insert into the spindle ISO 30 taper. The locking nut automatically will be on the lock position, to remove turn the self-locking nut to the left position, hold the spindle adapter, it may drop on the machine table. Damage will result.

### Installing the Spherical self Aligning Toolholder:

Once the spring free adapter is in the spindle, fit the Rottler Spherical Self aligning Tool holder assembly into the spindle adapter. Make sure to align the locator pins before you fit it into the spindle adapter and push it until you feel it lock.

### Fine Feed Engagement:

To engage the fine feed mechanism it is necessary to push inward on the spindle feed handwheel while rotating the fine feed handwheel until engagement is achieved. To disengage the fine feed simply pull outward on the spindle feed handwheel



## Rottler SG8M, SG9M, SG80M Control Panel

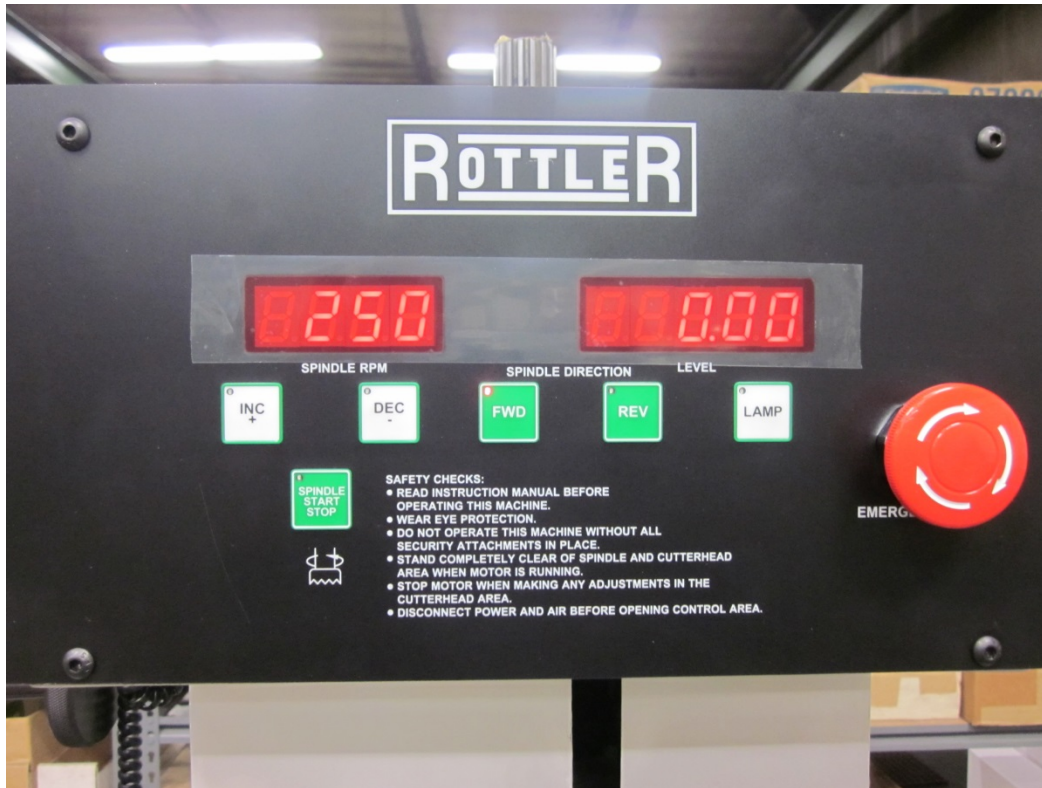

### Safety Tips Before Machining:

- Always wear proper Safety Items (such as safety glasses and other personal safety equipment as necessary or required).
- Never wear loose fitting clothes or jewelry while working on or around Machine.
- Use proper lifting procedures when moving Cylinder Head.
- Use care when installing and/or removing Cylinder Head from Machine. Lock Head Support Assembly before loading or unloading Cylinder Head.
- Keep area around Machine free of paper, oil, water and other debris at all times.
- Keep Machine and area cleaned of excessive lubricant and lubricant spills.
- Keep Machine clear of tools and other foreign objects not needed for the operation.
- Maintain all tools clean and in their proper storage compartments to maintain them in proper working condition and to prolong tool life.
- Before machining always inspect tooling for cracks, burrs or bent parts that might affect operation. Inspect Carbide Inserts (Seat Pocket Cutter) and Carbide Cutters (Seat Angle Cutter) to ensure they are sharp, firmly attached and are not damaged.
- NEVER force tools when operating. Tools will do a better and safer job when operated at speed rate for which they were designed.
- Always turn OFF electrical power when performing service on your machine, if service does not require power.
- High Voltage exists inside Electrical Control Enclosure – use caution when working on or around Enclosure. Machine must be disconnected from main power supply before any work can be performed inside of Enclosure.
- Machine must ONLY be operated with all Safety Guards in place and locked.

### Operation Tips before Machining Valve Seats:

DO NOT depress Foot Pedal once centering is completed as this will change machine and cylinder Head alignment.

Keep Spindle clean and dry. Never Used Oil.

Clean valve guide with a brush to remove foreign matter.

Required spindle rotation speed will vary, depending on seat hardness. As seat hardness increases, so does the spindle speed will change. Some will require full speed

**NOTE:** If valve guides are so badly worn that the proper centering will be impossible, it will be necessary to replace that valve guide to achieve the a concentric valve seat.  
See suggested machining speed chart below.

### SEAT MACHINING SUGGESTED RPM CHART

VALVE SEAT DIAMETER		SPINDLE SPEED
INCH	METRIC	RPM
15/16"	24	175
1.000"	25.4MM	150
1.125"	29MM	150
1.250"	32MM	125
1.375"	35MM	100
1.500"	38MM	100
1.625"	41MM	100
1.750"	44.5MM	100
1.875"	47.5MM	75
2.000"	51MM	75
2.125"	54MM	75
2.250"	57MM	75
2.375"	60MM	50
2.500"	63.5MM	50

### Valve Seat Machining Procedure

Seat Pocket and valve guide must be clean to ensure proper fit of the carbide pilot.

Select the correct Carbide pilot for the valve guide I.D. Diameter

At this point, the spindle and work head should be level according to the position of the cylinder head.

Fit the Rottler Tool Holder and pilot assembly into the spindle cone; make sure to align the locator pins before you fit it into the spindle adapter and push it until you feel that is lock.

The spindle has been engineered to allow ultra fast tooling changes.

Make sure the that spindle Self locking nut is in the off lock position; line up the two ears of the spindle adapter and insert into the spindle ISO 30 taper, the locking nut automatically will be on the lock position  
To remove turn the self-locking nut to the left position, hold the spindle adapter, it may drop on the machine table. Damage will result.

## UNIPILOT Centralizing Pilots

### Rottler UNIPILOT Solid Carbide Centralizing Pilots

are manufactured from fine grain, sintered tungsten carbide and are ground to a very high degree of accuracy, straightness, and surface finish. They are designed for a lifetime of precision machining

#### Pilot Diameter

The straight/parallel part of the pilot that fits in to the valve guide is referred to as the pilot diameter. Rottler pilots are available in 0.01mm (0.0004") increments. For best results, the clearance between the pilot and valve guide should not be more than 0.01mm (0.0004")

Most new valve guides are manufactured to a **nominal size** and the valve stem diameters are manufactured to be smaller than the nominal size to allow clearance for heat expansion of the valve stem when the engine is operating. For example: a 7mm valve guide has an internal diameter of exactly 7.00mm (.2756") The valve stem diameter of the intake valve is 6.98mm (.2748") and the exhaust is 6.96mm (.2740"). In order for the pilot to fit most of the valve guides, the first choice could be UCP0699 to give .01mm (0.0004") clearance. If the valve guide is used and has some wear, then the second choice of pilot could be UCP0700 (0.2756").

#### Shank Diameter

The part of the pilot that fits inside the tool holder is referred to as the shank. Rottler offers three different shank sizes (6.00mm, 9.52mm, and 20.00mm). For longest tool life and best seat cutting results, the shank needs to go as far as possible inside the tool holder when cutting valve seats or boring out valve seat housings.

#### Extended Length (EL) Pilots

Some cylinder heads require extended length pilots because the distance from the top of the valve guide to the head gasket surface is longer than normal. Normally this distance is about 1.0" - 1.5", it is when this distance becomes greater that extended length pilots are needed. The pilots are extended by adding material below the shank and above the tapered section of the pilot.

If you think you need an extended length pilot, please see the order form in the back of the catalog and contact Rottler for ordering assistance.



**PILOT DIAMETER SHOULD ALWAYS BE GREATER THAN VALVE STEM DIAMETER FOR BEST CONCENTRICITY**

## Modular Carbide Centralizing Pilot System for Valve Guides Over 0.875" (22.23mm)

Rottler also offers a modular carbide centralizing pilot system for very large engine applications. This system is versatile because it allows you to use different size sleeves, which are adjustable for different lengths, for different applications while using only one pilot. These sleeves are MADE TO ORDER. Contact Rottler for more information and ordering assistance.



**FCM20EL380** Modular Carbide Centralizing Pilot for Valve Guides Over 0.875" (22.23mm). Requires a set of Interchangeable Sleeves (FCMSLXXX & FCMSUXXX) - 20mmShank Pilot

**FCMSUXXX** Modular Pilot Upper (Tapered) Sleeve - Hardened and Heat Treated - For .XXX" (XX.XXmm) Guide ID

**FCMSLXXX**  
Modular Pilot Lower (Straight) Sleeve - Hardened and Heat Treated - For .XXX" (XX.XXmm Guide ID - 3.0" Overall Length



## Rottler Six and One Instructions



- 1- Checking the calibration of the six and one Setting Fixture included two tool setting fixtures, 1.250" / 31.750MM and .375" / 9.52MM and on the other end is 6.00MM. On the picture you will see master setting tool (.375" / 9.52MM) this one also will be using it to set you tool holders, for .375" (9.52mm) and 6.00MM ID tooling.,

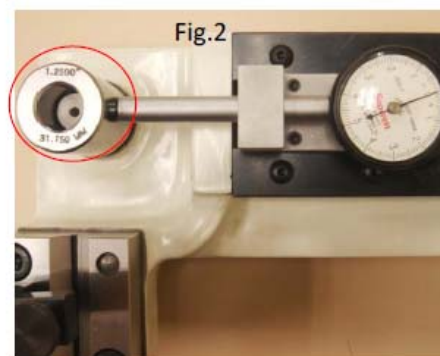
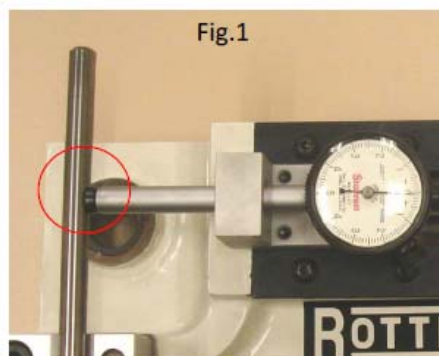

### Calibrating the Digital Micrometer

- 2- Turn the digital micrometer thimble in until the end of the micrometer is flush with the edge of the micrometer frame. Then turn the thimble out until the '0' mark on the thimble lines up exactly with the line on the barrel (see fig.1).



- a. Select mode: Press the **mm/in** button until the desired mode is shown in the digital display.  
**Note:** use a small instrument such as a pen to gently push the buttons; they are quite small and a bit delicate.
- b. Determine which calibrating setting tool you will be using to calibrate the micrometer is going to be used on. (example; calibrating pilot .375" / 952mm side)
- c. Press and hold the **SET** button, then press + or – button. "SET" will be flash in the display. This will place the micrometer in the edit mode
- d. Press and hold the + or – buttons to change the display number to the minimum set diameter Determined earlier (example; setting tool, pilot .375" / 9.52mm side).
- e. After it reach the proper reading, press the **SET** button to exit the edit mode. "SET" should no longer be shown in the display. The digital micrometer head is now set to the setting tool. (After initial setting, there is no need to press the SET button again unless display is lost at which time the micrometer must be reset)

### 3- MEASURE THE HEAD OF THE VALVE

- a. Position the Valve Stem on V Block and bring the Indicator tip to may contact with the head of the Valve until zero show on the indicator dial, the amount showing of the digital micrometer display is the actual diameter of the Head of the Valve.
- b. From that reading 2.0001"

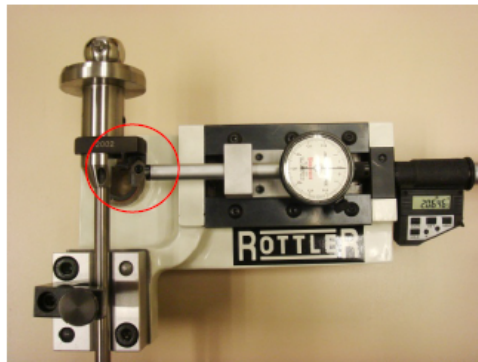
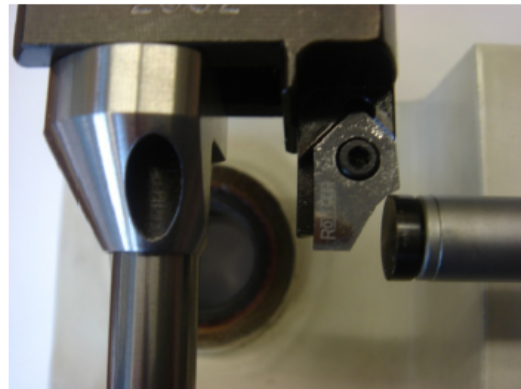
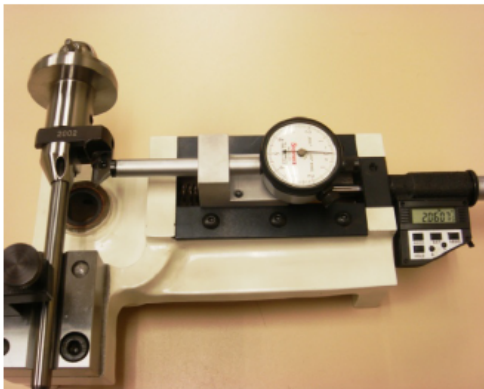
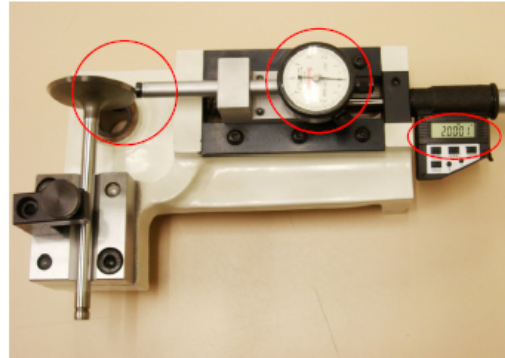

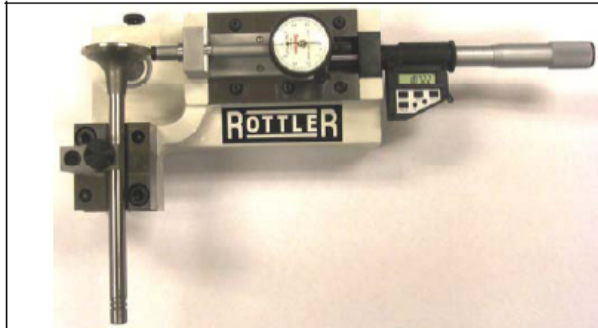

MEASURE VALVE HEAD DIA



MEASURE VALVE STEM AND PILOT DIA.

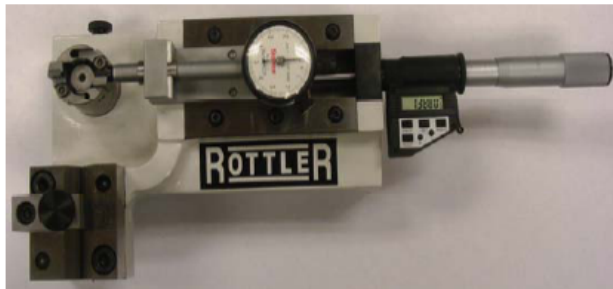

SET ADJUSTABLE DOUBLE INSERT MILLING CUTTERS



SET ADJUSTABLE DOUBLE INSERT MILLING CUTTERS

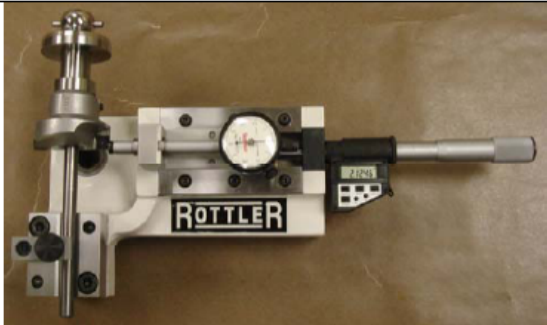

SET BORING INSERT FOR HOUSING DIA.



SET BORING INSERT FOR HOUSING DIA WITH TRIANGLE

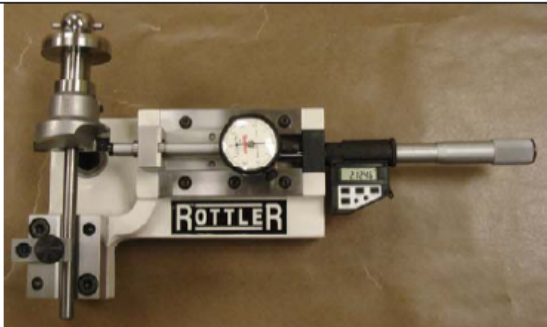

SET BORING INSERT FOR HOUSING DIA.



SET BORING INSERT FOR HOUSING DIA

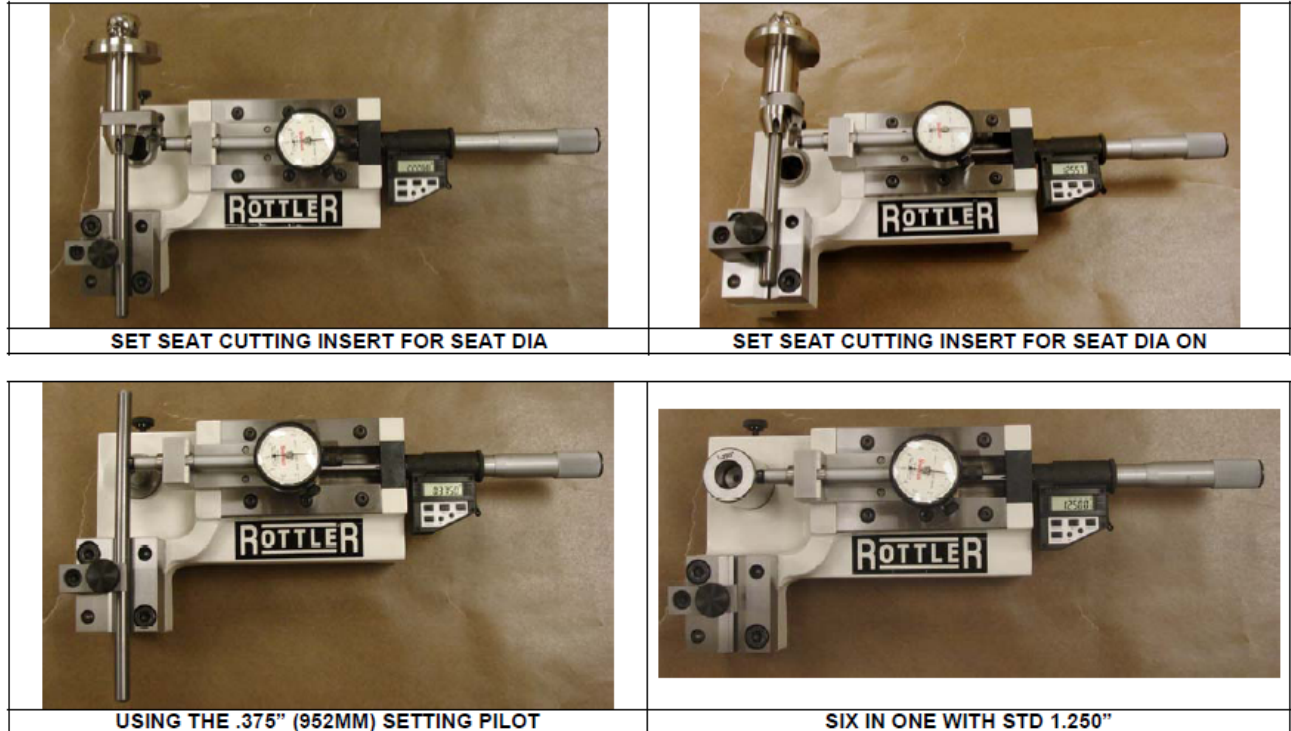

### Adjusting the Square Carbide Inserts:

The micrometer should be used.

Set the Digital micrometer (BM) according to the valve seat insert diameter and the required interference.

Slide the tool holder without the pilot on the micrometer.

With the setting screw, adjust the square tip holder offset.

**IMPORTANT:** When 90 degree bits (RCA512) or the Triangle bits are fitted, check that their reference faces are perfectly clean.



The accuracy of the seat angles depends on this.

While rotating the assembly tool holder/carbide tip holder, the carbide bit's cutting edge should just touch the micrometer spindle.

Once in contact with the micrometer spindle, the carbide tip should not be moved at all. If this is not observed, the cutting edge may be damaged and the resulting surface quality, when machining, will be deteriorated.

## Contents

Maintenance.....	2
Quick Reference Lubrication Chart: .....	2
Preventative Maintenance Quick Reference Chart: .....	2
Air Adjustments: .....	3
Float: .....	3
Float surfaces: .....	3
Calibrating the Digital Level:.....	4
Setting of the foot pedal operated system actuated valve if misadjust .....	5
Adjusting and aligning the outer spindle on SG models.....	6
Adjusting outer spindle clearance. ....	7

## Maintenance

### Quick Reference Lubrication Chart:

Refer to the maintenance section in the manual for lubrication location points and instruction.

Assembly	Frequency	Lube Operation	Recommended Lubricant	Date Serviced
Outer Spindle	8 Hours	Clean and Wipe with oil	Conoco Brand "76 Way Oil HD 68" ISO VG 68	
Brass guide shoes/slide	500 Hours	Clean and wipe with oil	Conoco Brand "76 Way Oil HD 68" ISO VG 68	
Grease spindle Rack and pinion	500 Hours	Clean and grease	Unoba EP2 or equivalent NLGI 2 Multi Purpose Grease	
Grease spindle worm wheel and worm shaft	500 Hours	Clean and grease	Unoba EP2 or equivalent NLGI 2 Multi Purpose Grease	
Grease spindle drive shaft	500 Hours	Clean and grease	Unoba EP2 or equivalent NLGI 2 Multi Purpose Grease	
Grease rollover clamp fixture bearings	200 Hours	Clean and grease	Unoba EP2 or equivalent NLGI 2 Multi Purpose Grease	
Grease clamp fixture Pins and Acme screw	200 Hours	Clean and grease	Unoba EP2 or equivalent NLGI 2 Multi Purpose Grease	

### Preventative Maintenance Quick Reference Chart:

Refer to the procedures in the maintenance section of the manual to make or check these adjustments.

**Not all of the items listed in the table below have adjustment.** The information should be recorded and the amount of wear tracked so the part can be replaced before down time on the machine occurs.

Procedure	Frequency	Date Serviced/Comments
Clean top and bottom float tables	8 Hours	
Outer Spindle Bushing Adjustment	500 Hours	
Brass Shoe Adjustment	500 Hours	
Angle sensor calibration	500 Hours	
Spindle Drive Belt Adjustment	1000 Hours	
Adjust workhead clamp plate bearings	1000 Hours	
Rack and pinion adjustment.	1000 Hours	
Machine Level Adjustment	1000 Hours	

**CAUTION**

All floating surfaces should be dry and clean do not oil the surfaces, oil will cause the work heat not to float properly.

**Air Adjustments:****Float:**

The float regulator is located to the right of the main regulator.

If the machine is not floating properly, it could be from too much or too little air from the regulator. Turn the regulator all the way off (full counter clockwise). Start turning the regulator slowly clockwise while continually checking the Work Head for proper floatation. Once the correct float is established, lock the regulator into place by pushing in on the blue adjusting knob.

**CAUTION**

Use as little air as possible to achieve correct floatation. Using too much air will could cause the spindle base to vibrate and not center properly on the on the pilot.

**Float surfaces:****CAUTION**

Wipe clean daily

All floating surfaces should be dry and clean do not oil the surfaces, oil will cause the work heat not to float properly.

## Calibrating the Digital Level:

**NOTE:** Even though the level has been carefully calibrated at the factory, it is a good idea to recheck calibration before putting the machine into service. In the event that the level is dropped or handled roughly then the following recalibration methods should be implemented.

The level assembly is referenced to the spindle via the level pin. It is there for important to check alignment of pin in reference to the spindle. This is accomplished by mounting a magnetic base dial indicator to the machine spindle and sweeping the pin vertically by raising or lowering spindle to check alignment. Pin alignment should be checked in two positions at 90 degrees to each other. If the pin alignment needs correcting, do so with the set screws located at base of pin block.

Install level on pin. Orient level to read left to right. Tilt head left or right until level reads 0.00. Now rotate level 180 degrees. The reading should be 0.00, if not then it will be necessary to calibrate the inclinometer to the level body. This is accomplished by loosening the inclinometer's two retaining screws and pivoting the inclinometer until it repeats when level is rotated 180 degrees.

Example: level reads 0.05 to the left, when rotated 180 degrees to the right it should read minus 0.05.

Check the level reading with the pickup oriented front to back. It should read 0.00 if the machine has been properly leveled with a machinist level.

If the LED does not read 0.00 then chances are the machine's leveling procedures have not been properly followed or there are internal problems with the level's electronics.

The sensitivity of the level is so great that it may not zero totally, even while the machine is not being touched. The alignment tolerance for installing guides is plus or minus .05 degrees, and for forming three angle seats is plus or minus .05 degrees.





### Setting of the foot pedal operated system actuation valve if misadjusted

When the foot pedal is not pressed, the clearance between the left valve plunger (when looking from the front of the machine) and the foot pedal bracket should be 0.010" (0.20mm) whereas the clearance between the right valve plunger and the foot pedal bracket should be 0.039" (0.75mm).

This can be achieved by loosening the two fixing screws and adjusting the valve mounting bracket.

Tighten back the bracket ( see fig below).

When the foot pedal is pressed, remove the black air tube from the left port and it should be a full air flow, whereas when you remove the green air tube from the right port it should not be any air coming out.

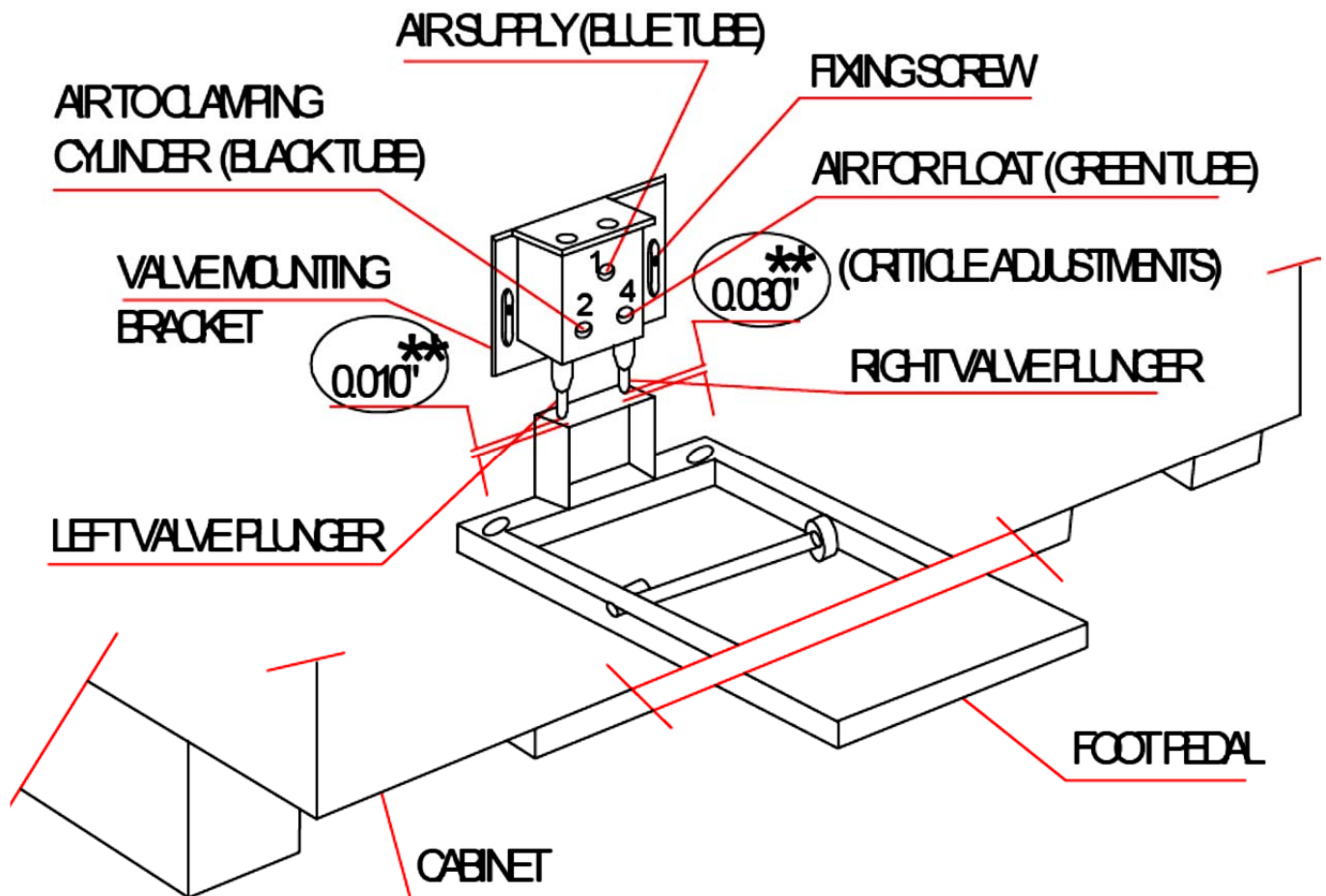

### Adjusting and aligning the outer spindle on SG models

There are 2 brass guide shoes located on the guide plate on top of the spindle that align the rack gear on the back of the spindle with the pinion gear that moves the spindle up and down.

Lower the spindle to the center position of travel.

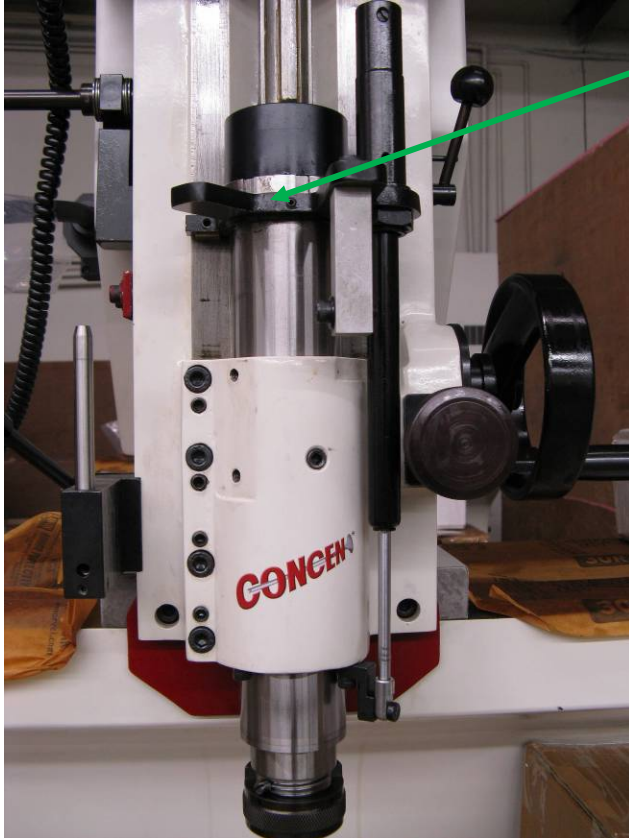

Check the guide plate at the top of the spindle, tighten if necessary.

Clean and lightly lubricate sliding guide surfaces with grease. Adjust brass guide shoes on guide plate so that there is no twisting movement. Run the spindle through its full travel to confirm that there is no binding.

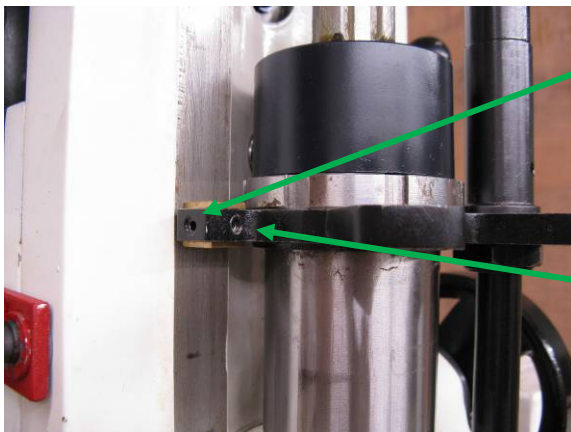

Loosen locking screw to adjust brass guide shoe. Tighten after adjusting.

Use adjusting screw to adjust brass guide shoe.

### Adjusting outer spindle clearance.



Loosen the 4 lock bolts.



Loosen the 4 adjusting set screws.

Clean outer spindle and lubricate – add a few drops of oil to a clean cloth and wipe outer spindle.

Starting with the bottom set of lock bolt and adjusting set screws, tighten the lock bolt until there is drag on the spindle when it is move through its range of travel.

Then tighten the adjusting set screw until the amount of drag on the spindle is reduced to the point that there is a slight drag on the spindle through its range of travel.

You may have to make further adjustment to the lock bolt and set screw the get the spindle adjusted properly.

Repeat the above procedure the other 3 sets of lock bolts and set screws.

This page intentionally left blank

## Troubleshooting

### Eccentricity Problems when Cutting Three Angle Seats:

Spindle floated to improper center location.  
 Excessive pressure when forming seat.  
 Incorrect spindle speed.  
 Worn or improperly selected pilot.  
 Worn Valve Guide.

<p>Workhead base does not float</p> <p>Concentricity is not within the tolerance</p>	<p>1- Insufficient air pressure</p> <p>2- Clamping plate does not drop when unclamped due to less clearance between upper floating base and ball bearings mounted on clamping plate</p> <p>3- Clamping plate does not drop when unclamped due to the improper adjustment of the four clamping bolts.</p>	<p>1- Set air pressure of supplied line should be minimum <b>90 PSI ( 6 Bars)</b></p> <p>2- Adjust 4 corner air adjustment higher</p> <p>2- Take the workhead to one end of the of the upper floating surfaces (Left or Right side) float the workhead and pull it against the front on the T Slatted guide surfaces, then loose the set screws of the eccentric pin to increase clearance by using a feeler gage of 0.008" to 0.010" (0.20mm to 0.25mm) in between the T slotted guide surfaces of the upper base and the eccentric ball bearing; (see fig. below)</p> <div data-bbox="876 840 1412 1176"> </div> <p>Lock the setscrews, remove the feeler gage and inspect if is with the tolerance across the all surfaces. Repeat if it is necessary.</p> <p>3- Adjust nylock nuts (SG10A and SG9M have bolts in this position) to set he correct clearance between the bottom side face of the locking T-Slot of the floating base (Riser) and the top part of the clamping plate. There are 2 clamping bolts , one each side. The dropping clearance when it is on the floating mode should be 0.015" (0.38mm)on all the four corners of the workhead clamping plate (see fig. 5-6)</p>
--	--	---



Fig1

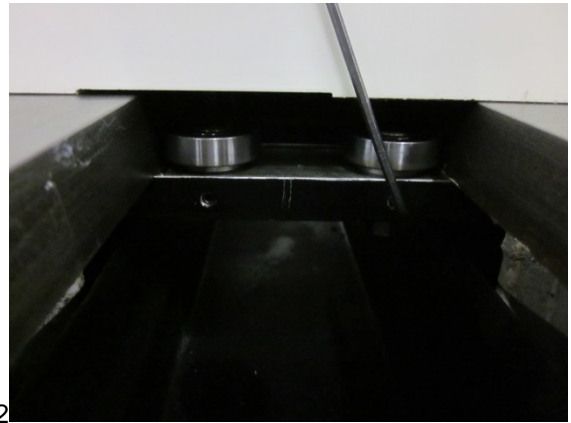

Fig2

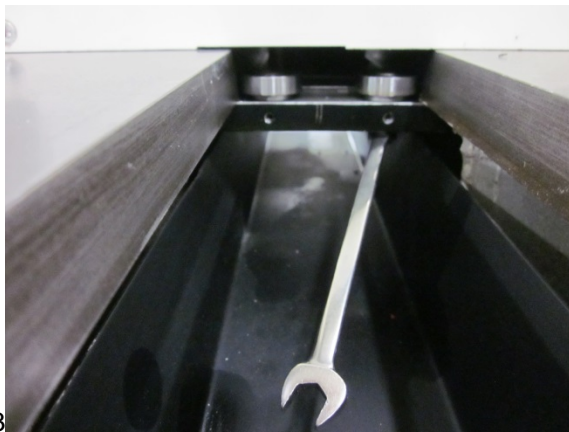

Fig3



Fig4

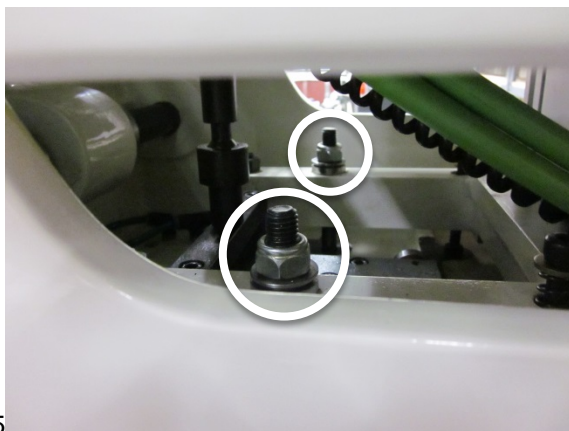

Fig5



Fig6

## SG Fault and Error Codes

Errors are sensed by the SG controller.  
 Faults are sensed by the motor driver.  
 Alarms are sensed by the motor driver.

The left display shows Err.  
 The left display shows FLt.  
 The left display shows ALr.

To clear an error requires the condition be resolved (correct wiring...) and cycle the e-stop.

To clear fault requires the condition be resolved (correct wiring...), press the reset key on the drive front panel, and cycle the e-stop. If e-stop is cycled long enough the drive will power down and that will clear the fault too.

Alarms clear as the condition that caused them disappears (the over torque is relieved...).

Error Display	Description
C bUS	Communications lost with drive
<b>Fault Display</b>	
Uv1	Undervoltage
Uv2	Control Power Supply Undervoltage
Uv3	Soft Charge Circuit Fault
GF	Ground Fault
oC	Overcurrent
ov	Overvoltage
oH	Heatsink Overheat
oH1	Heatsink Overheat
oH3	Motor Overheat (PTC input)
oH4	Motor Overheat (PTC input)
rH	Braking Resistor Overheat
oL1	Motor Overload
oL2	Drive Overload
oL3	Overtorque Detection 1
oL4	Overtorque Detection 2
oL7	High Slip Braking Overload
rr	Dynamic Braking Transistor
EF1	External Fault 1, input terminal S1
EF2	External Fault 2, input terminal S2
EF3	External Fault at input terminal S3
EF4	External Fault at input terminal S4
EF5	External Fault at input terminal S5
EF6	External Fault at input terminal S6
EF7	External Fault at input terminal S7

oS	Overspeed
dEv	Excessive Speed Deviation
PGo	PG Disconnect
PF	Input Phase Loss
LF	Output Phase Loss
oPr	Digital Operator Connection
Err	EEPROM Write Error
CE	MEMOBUS/Modbus Communication Error
bUS	Option Communication Error
CF	Control fault
EF0	PROFIBUS-DP Option External Fault
FbL	PID Feedback Loss
UL3	Undertorque Detection 1
UL4	Undertorque Detection 2
oF1	Hardware Fault
LF2	Output Current Imbalance
Sto	Pullout Detection
PGo	PG Disconnected
SEr	Too many speed search restarts
FbH	PID Feedback Loss
oL5	Mechanical Weakening Detection 1
UL5	Mechanical Weakening Detection 2
CoF	Current Offset Fault
dWFL	DriveWorksEZ Fault
CPF02	A/D Conversion Error
CPF03	PWM Data Fault
CPF06	Drive specification mismatch during Terminal Board or Control Board replacement
CPF07	Terminal Board Communication Fault
CPF08	EEPROM Serial Communication Fault
CPF11	RAM fault
CPF12	Flash memory circuit exception
CPF13	Watchdog circuit exception
CPF14	Control Circuit Fault
CPF16	Clock Fault
CPF17	Timing Fault
CPF18	Control Circuit Fault
CPF19	Control Circuit Fault
CPF20	Hardware fault at power up
CPF21	Hardware fault at communication start up



CPF22	A/D Conversion Fault
CPF23	PWM Feedback Fault
CPF24	Drive capacity signal fault
oFA00	Option compatibility error
oFA01	Option not properly connected
oFA03	Option Self-diagnostics Error
oFA04	Option Flash Write Mode Error
<b>Alarm Display</b>	<b>Description</b>
Uv	Undervoltage
ov	Overvoltage
oH	Heatsink Overheat
oH2	Drive Overheat
oH3	Motor Overheat
oL3	Overtorque 1
oL4	Overtorque 2
EF	Run commands input error
bb	Drive Baseblock
EF1	External Fault 1, input terminal S1
EF2	External Fault 2, input terminal S2
EF3	External Fault 3, input terminal S3
EF4	External Fault 4, input terminal S4
EF5	External Fault 5, input terminal S5
EF6	External Fault 6, input terminal S6
EF7	External Fault 7, input terminal S7
FAN	Cooling Fan Error
oS	Overspeed
dEv	Excessive Speed Deviation
PGo	PG Disconnected
oPr	Digital operator connection fault
CE	Modbus Communication Error
bUS	Option Communication Error
CALL	Serial Communication Transmission Error
oL1	Motor Overload
oL2	Drive Overload
EF0	Option Card External Fault
rUn	Motor Switch command input during run
UL3	Undertorque Detection 1
UL4	Undertorque Detection 2
SE	MEMOBUS/Modbus Test Mode Fault

FbL	PID Feedback Loss
FbH	PID Feedback Loss
dnE	Drive Disabled
PGo	PG Disconnected
HCA	High Current Alarm
HbbF	Safe Disable Input
Hbb	Safe Disable Input
oL5	Mechanical Weakening Detection 1
UL5	Mechanical Weakening Detection 2
dWAL	DriveWorksEZ Alarm
<b>RT4 Error Codes</b>	<b>Description</b>
1	failed communication to display boardd
2	no motor voltage (blown fuse)
3	no motor current (lost motor conn)
4	over current >6.8 amps (short)
5	over current, >4.5 amp for 2 sec (slow)
6	over current >10 amp for 1/100 sec (fast)

## Contents

Machine Parts .....	2
Consumable Parts.....	2
Carbide Inserts: .....	3
Special Profiles.....	3
Carbide Pilots .....	3
Base, Table and Riser Assembly .....	5
Base, Table and Riser Assembly Parts List .....	6
Base Assembly.....	8
Base Assembly Parts List.....	9
Spindle Assembly .....	11
Spindle Assembly Parts List.....	12
Transmission Assembly.....	15
Transmission Assembly Parts List .....	16
HEAD SUPPORT ASSYEMBLY .....	18
HEAD SUPPORT ASSEMBLY PARTS LIST .....	19
Wiring Diagram.....	21
Pneumatic Drawing .....	22
DECIMAL TO METRIC CONVERSION CHART.....	23

## Machine Parts

### Consumable Parts

REFERENCE	DESCRIPTION
SLEEVE R1	Spindle adapter replacement sleeve
BSW002	Diamond Wheel Cutting Bit Sharpener replacement Wheel (3.000" Diameter OD by .375" ID)
PRW600PIN	Replaceable Pins for PRW600 Pilot Removable wrench tool
PRW375PIN	Replaceable Pins for PRW375 Pilot Removable wrench tool
PRW20PIN	Replaceable Pins for PRW375 Pilot Removable wrench tool
VT-FP1562	Replacement Foam Pad for Round Vacuum Pad 1.562" diameter
VT-FP1875	Replacement Foam Pad for Round Vacuum Pad 1.875" diameter
VT-FP2125	Replacement Foam Pad for Round Vacuum Pad 2.125" diameter
VT-FP3125	Replacement Foam Pad for Round Vacuum Pad 3.125" diameter
VT-FP25X22	Replacement Foam Pad for Square Vacuum Pad 2.500" x 2.250" square
VT-FP31X20	Replacement Foam Pad for Square Vacuum Pad 3.125" x 2.000" square
VT-FP33X27	Replacement Foam Pad for Square Vacuum Pad 3.375" x 2.750" square
511-29-12F	T7 Torx driver for 1/4" insert (straight angle insert holders only)
511-29-12E	TORX SCREW M2.5 X 0.45 X (straight angle insert holders only)
T8S	T8 Torx Tip Holding Screws
T15S	T15 Torx Tip Holding Screws
MHS-375	Fixed Double Replaceable Insert Milling Head Screws for Large diameter milling Head (3/8" insert)
MHS-250	Fixed Double Replaceable Insert Milling Head Screws for Small diameter milling Head (1/4" insert)
S1032-250	BH375R1 and BH600R1 Tip Holder Looking Screw (10/32" X 1/4") <b>Req. 2</b>
S250-28-250	BH375WR1 Tip Holder Looking Screw 1/4"-28" X 1/4" <b>Req. 2</b>
S1032-437	TH1999 Adjusting Screw (10/32" X 7/16")
S1032-375	TH2000 Adjusting Screw (10/32" X 3/8")
S1032-500	TH2001 Adjusting Screw (10/32" X 1/2")
S1032-625	TH2002 Adjusting Screw (10/32" X 5/8")
S600-1570	TH2003 Adjusting Screw (6.00mm X 15.70mm)
S600-2015	TH2004 Adjusting Screw (6.00mm X 20.15mm)
M10X15X35	SG7 Rollover Fixture Hold down swivel Handle Zinc Handle 35mm (1.375") Long stud (KHF-725)
500-13X2	SG8M Rollover Fixture Hold down swivel Handle Zinc Handle 2.000" Long stud (KHF-162)
500-13X1375	SG7- SG8M Rollover Fixture Lock swivel Handle Zinc Handle 1.375" Long stud (KHF-158)
ICC003	Insert, Indexable carbide, for Fixed milling heads - large size - for 1.562" and larger cutters
ICC002	Insert, Indexable, carbide, for Fixed milling heads - small size - for 1.250" to 1.500" cutters

### Carbide Inserts:

See Carbide Insert Catalog for a complete list of Insert Profiles available from Rottler Manufacturing.

### Special Profiles

Special Profile Cutter Inserts can be manufactured to your exact specifications and can include a combination of angles and radius blends.

There is three different style insert blanks.

A - Style Blank insert, **RCA** is a small insert for all standard applications.

B - Style Blank insert, **RCB** in design for long profiles like High Performances profiles with multi angles o Radius or other special applications

C - Style Blank insert, **RCC** is a much thicker insert for Heavy Duty tooling and can be use for hard seat materials (will work only on the Large Inserts holders series 3000 style insert holders, for the 20.00mm tooling)

Special Order - Special Profile Carbide Cutter Bits are generally considered to be "Customer Proprietary". These are uniquely numbered, exclusively for the ordering customer; prices will vary depending on quantities and additional charge for initial run.

Call us for a quote.

RT312 Insert, triangular positive rake, 3/8 1/32" (.787mm) radius, for the TH3000 series insert holder and RT212 Insert, triangular positive rake, 1/4" (6.35mm) 1/32 " radius for the TH2000 series, for hard seat materials applications (Counterboring and straight angles only )

### Carbide Pilots

See Carbide Pilot catalog for a complete list of Pilots available.

**Rottler Solid Fixed Carbide Pilots** are manufactured from fine grain sintered tungsten carbide and are ground to a very high degree of accuracy, straightness and surface finish - designed for a life time of precision machining!

The part number of the pilot represents the actual diameter in metric of the straight/parallel part of the pilot where the pilot fits into the valve guide.

For example:

**UCP0700** means that the diameter of the part of the pilot that goes into the valve guide is **7.00mm (0.2756")**

**UCP1270** means that the diameter of the part of the pilot that goes into the valve guide is **12.70mm (0.5000")**

Pilots are available in increments of .01mm (0.0004"). Normally, a small amount of clearance approx .01mm (0.0004") is required between the pilot and the valve guide.

Most new valve guides are manufactured to a **nominal size** and the valve stem diameters are manufactured to be smaller than the nominal size to allow clearance for heat expansion of the valve stem when the engine is operating. For example: a 7mm valve guide has an internal diameter of exactly 7.00mm (.2756") The valve stem diameter of the intake valve is 6.98mm (.2748") and the exhaust is 6.96mm (.2740"). In order for the pilot to fit most all valve guides, the first choice could be UCP0699 to give .01mm (0.0004") clearance. If the valve guide is used and has some wear, then the second choice of pilot could be UCP0700(0.2756").

Rottler makes 3 sizes of shanks of pilots:

6.00mm (0.2362") for small valves guides 6mm (0.236") and below. The part number for these pilots is UCPM.

0.375" (9.52mm) for common size valve guides, 6-14mm (.236-.625"). The part number for these pilots is UCP.

20mm (0.7874mm) for large valve guides for SG8M0A machine. These pilots are made to order specifications.

### Base, Table and Riser Assembly

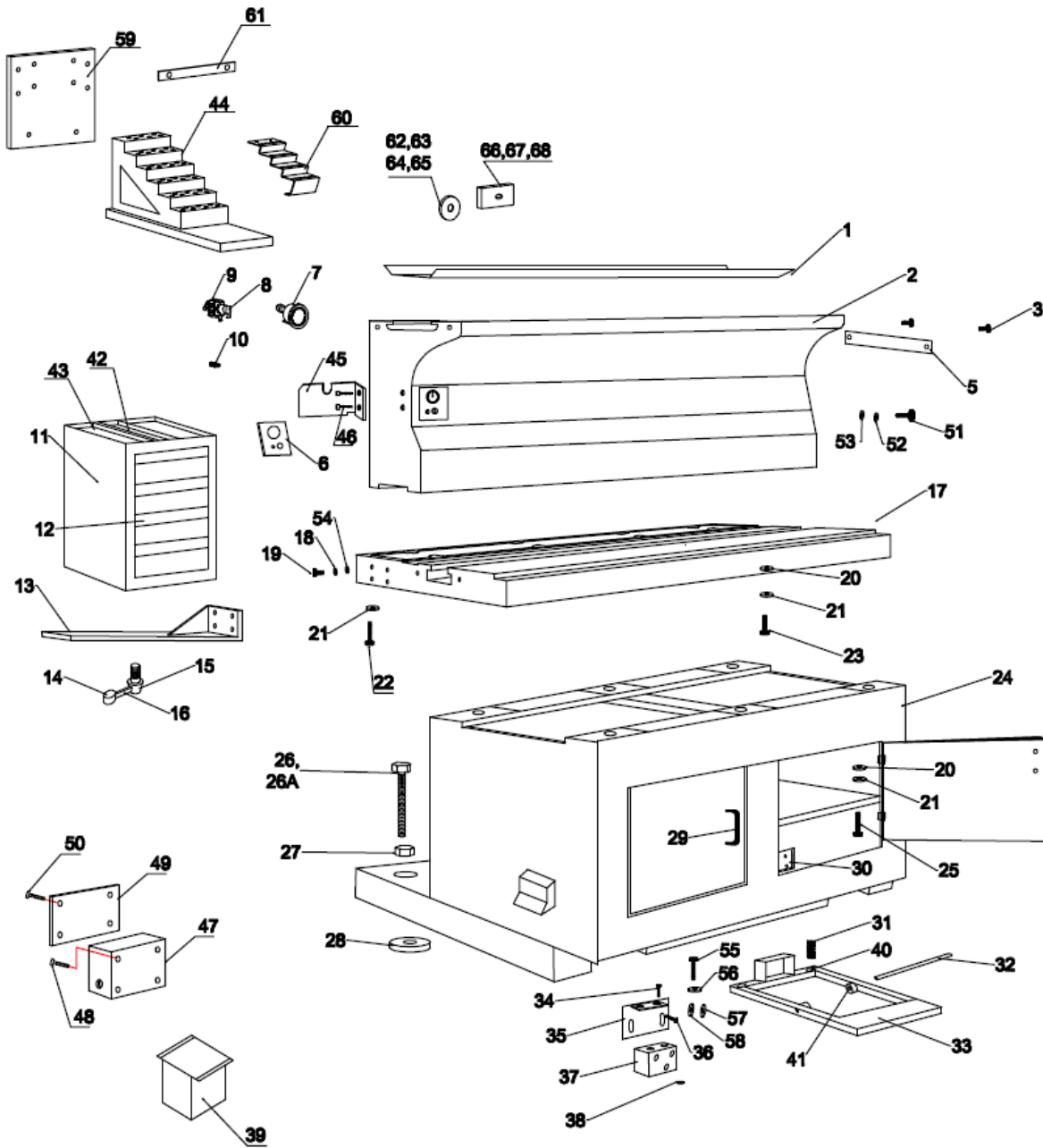

**Base, Table and Riser Assembly Parts List**

S.NO.	PART NO.	DRG. NO.	DESCRIPTION	QTY/M/C
1	430-820-1	8M-38	COVER PAN	1
2	430-815-2	8M-01	RISER	1
3	430-822		BUTTON HEAD SCREW (M6x12)	4
4				
5	430-821-1	8M-27	STOP PLATE	2
6	033-071	033-09	PLATE	1
7	430-830		VACCUM GAUGE 2.5" STD-B X ¼ NPT	1
8	430-831		N-22-SW (9301)	1
9	430-832		SV-3-M5 (6817)	1
10	430-837		QSS-6 (153158)	1
11	430-807	8M-32	TOOL CABINET	1
12	430-816		TOOL TRAY	4
13	430-806	8M-28	MOUNTING BRACKET	1
14	430-802		KNOB (M8XOD25MM)	1
15	430-817-1	8M-08	CLAMP PIN	1
16	430-823	8M-09	CLAMP LEVER	1
17	NC-41	8M-02	TABLE	1
18	VGS-804		SPRING WASHER (M8)	4
19	VGS-803		ALLEN HEAD SCREW (M8x30)	4
20	430-811		PLAIN WASHER	11
21	430-810		LOCK WASHER	14
22	430-809		ALLEN HEAD SCREW (M12x70)	3
23	430-812		ALLEN HEAD SCREW (M12x50)	7
24	430-801	8M-03	CABINET ASSY	1
25	430-813		HEX SCREW (M12x50)	4
26	430-818	8M-16	LEVELING BOLT (M16 X 75)	5
26A	<b>430-818-1</b>	<b>8M-16A</b>	<b>LEVELING BOLT (M16x180)</b>	<b>1</b>
27	430-818A		HEX NUT (M16)	6
28	430-819	8M-17	PAD	6
29	430-825		HANDLE	2
30	430-827		MEGNET BLOCK	2
31	430-833		SPRING	2
32	430-834	8M-18	ROD	1
33	430-835	8M-29	FRAME WELDED	1
34	430-838		ALLEN HEAD SCREW (M5x12)	2
35	430-836	8M-30	FOOT SWITCH MTG. BKT	1
36	430-814		ALLEN HEAD SCREW (M6x20)	2
37	430-828		FOOT SWITCH ASSY	1
38	430-805		NUT (M5)	2
39	430-824	8M-31	CHIP TRAY	1
40	430-835A	8M-10	PAD	2
41	430-835B	8M-11	BUSH	2
42	430-826-1		RUBBER SHEET	1
43	430-829-1	8M-19	TOOL BOARD (L.H)	1
44	430-839-1		PILOT STAND	1
45	033-069	033-07	SUPPORT BRACKET	1
46			ALLEN HEAD SCREW (M6x16)	2
47	430-PP6	8M-33	JUNCTION BOX	1
48			ALLEN HEAD SCREW M5X10	4
49	430-PP7	8M-34	COVER	1
50			ALLEN HEAD CAP SCREW M5X8	4



S. NO.	PART NO.	DRG. NO.	DESCRIPTION	QTY/M/C
51			ALLEN HEAD SCREW (M10x25)	4
52			SPRING WASHER (10mm)	4
53			PLAIN WASHER (10mm)	4
54			PLAIN WASHER (8mm)	4
55			ALLEN HEAD SCREW (M6x30)	2
56			NUT (M6)	2
57			PLAIN WASHER (6mm)	2
58			LOCK WASHER (6mm)	2
59	430-839-2	8M-35	SUPPORT PLATE	1
60	430-839-3	8M-36	RACK (INSERT HOLDER)	1
61	430-839-4	8M-37	NAME PLATE	2
62	101A-109	8M-20	VACUUM PAD	1
63	101A-110	8M-21	VACUUM PAD	1
64	101A-111	8M-22	VACUUM PAD	1
65	101A-112	8M-23	VACUUM PAD	1
66	101A-113	8M-24	VACUUM PAD	1
67	101A-114	8M-25	VACUUM PAD	1
68	101A-115	8M-26	VACUUM PAD	1
69	<b>430-815-S-1</b>	<b>8M-12</b>	<b>SHIPPING CLAMP (NOT SHOWN)</b>	<b>2</b>
70	<b>430-841</b>	<b>8M-13</b>	<b>PIN (NOT SHOWN)</b>	<b>4</b>
71	<b>430-842</b>	<b>8M-14</b>	<b>PIN (NOT SHOWN)</b>	<b>3</b>
72	<b>430-843</b>	<b>8M-15</b>	<b>PIN (NOT SHOWN)</b>	<b>4</b>

### Base Assembly

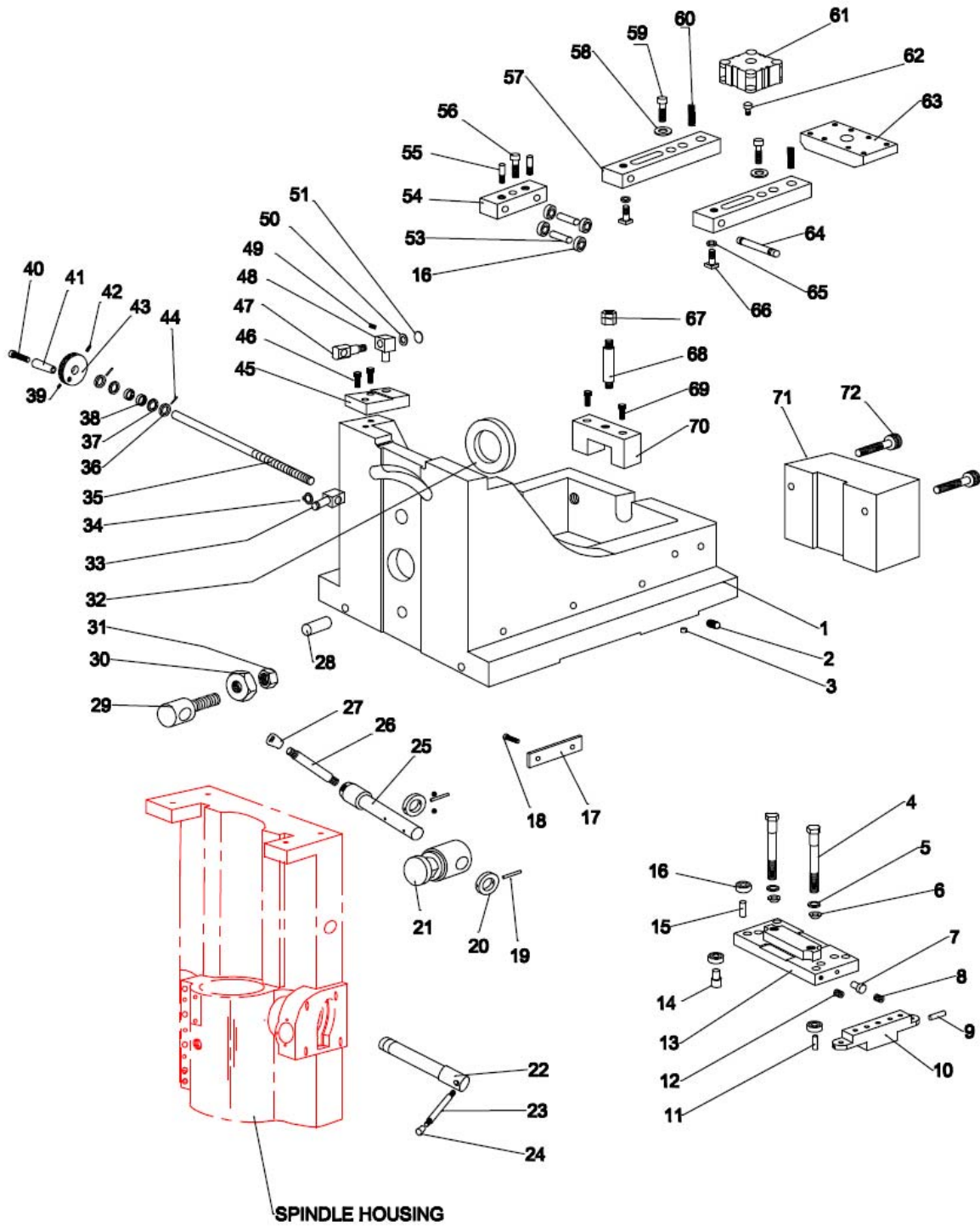

**Base Assembly Parts List**

S. NO.	PART NO.	DRG. NO.	DESCRIPTION	QTY/M/C
1	430-514-1	8M-61	BASE	1
2	VGS-512		PLUG (1/8 NPT)	4
3	VGS-513	8M-79	PLUG (BRASS)	12
4	430-509-1	8M-80	HEX. BOLT (M12x110)	2
5	NC-112-II	8M-81	SPHERICAL WASHER	2
6	NC-112-I	8M-82	SPHERICAL WASHER	2
7	NC-138	8M-83	NYLON PLUG (DIA.0.170"x0.370")	2
8			GRUB SCREW (M6x6)	2
9	NC-139	8M-84	NYLON STOPPER (DIA.0.130"x0.250")	2
10	NC-122	8M-70	CROSS STOP FLAT	1
11	430-504-1	8M-108	PIN	2
12	VGS-507		GRUB SCREW (M5x6)	2
13	430-501-1	8M-62	CLAMP PLATE	1
14	430-506	8M-85	ECCENTRIC PIN	2
15	430-502	8M-109	PIN	2
16	VGS-505		BALL BEARING	10
17	NC-25-1AC	8M-118	CABLE CLIP	1
18			ALLEN HEAD SCREW (M4x12)	2
19	430-552	8M-104	TAPER PIN	2
20	430-510	8M-68	ECCENTRIC COLLAR	2
21	430-629-1	8M-71	CLAMP PIN	1
22	NC-35-1	8M-69	ECCENTRIC CLAMP	1
23	NC-39	8M-110	LEVER PIN	1
24	VGS-522		KNOB (M1/4", O.D.1")	1
25	NC-34-1	8M-86	CLAMP	1
26	430-516	8M-111	LEVER	1
27	430-517		KNOB (M8x50 LONG)	1
28	430-629-2	8M-72	PIVOT PIN	1
29	430-670	8M-87	EYE BOLT	1
30	VGS-640	8M-112	NUT	1
31			NYLOCK NUT (M10)	1
32	430-520	8M-78	SPACER	1
33	430-523	8M-88	ADJUSTING NUT	1
34	430-524		RETAINING RING	1
35	430-526	8M-89	INCLINATION ROD	1
36	430-548	8M-90	RETAINING RING	2
37	430-551		NEEDLE BEARING (12x16x10)	1
38	430-550		THRUST BEARING (12x26x4)	2
39	430-530		GRUB SCR. (M6x6) FLAT PT.	1
40	430-533		ALLEN HD SCREW (M8x70)	1
41	430-532	8M-91	HANDLE	1
42	430-529		SET SCREW (M8x20) FLAT POINT	1
43	430-531	8M-113	KNOB	1
44	430-549		SPRING PIN	2
45	430-521	8M-92	SWIVALING BLOCK	1
46			ALLEN HEAD SCREW (M6x16)	2
47	430-525	8M-93	SWIVALING PIN	1
48	430-522	8M-94	PIN HOLDER	1
49			GRUB SCREW (M6x6)	1
50	430-527	8M-95	WASHER	1
51	430-528		NYLOCK NUT (M10)	1

S. NO.	PART NO.	DRG. NO.	DESCRIPTION	QTY/M/C
53	NC-120	8M-96	ROD	2
54	NC-119	8M-97	BEARING BLOCK	1
55	NC-121	8M-98	JACK SCREW	2
56			ALLEN HEAD SCR. (M6x35)	1
57	NC-109	8M-73	CLAMP ARM	2
58			PLAIN WASHER	2
59			ALLEN HEAD BOLT (M8x90)	2
60			SPRING (1.25x12x9x41)	2
61			PNUMATIC CYLINDER (ADVU-63-10-P-A) 156559	1
62	NC-114	8M-99	CYLINDER PAD	1
63	NC-108	8M-100	CYLINDER MOUNTING PLATE	1
64	NC-110	8M-101	CLAMP ARM TIE ROD	1
65	NC-113	8M-102	SPACER	2
66	NC-111	8M-64	SQUARE BOLT	2
67	VGS-535	8M-114	NUT ( NEST)	1
68	430-534-1	8M-115	STUD	1
69			ALLEN HEAD SCREW (M6x35)	2
70	NC-115	8M-103	PIVOT SUPPORT	1
71	430-518-1	9M-22	WEIGHT	1
72	430-519		ALLEN HEAD SCREW (M12x90)	2
73	430-514-A	8M-105	BASE COVER PLATE (NOT SHOWN)	1
74	430-514-S-1	8M-106	CLAMP PLATE (NOT SHOWN)	1
75	430-514-S-2	8M-107	SHIPPING CLAMP (NOT SHOWN)	2
76	430-514-S-3	8M-116	SHIPPING CLAMP BRACKET	2

# Spindle Assembly

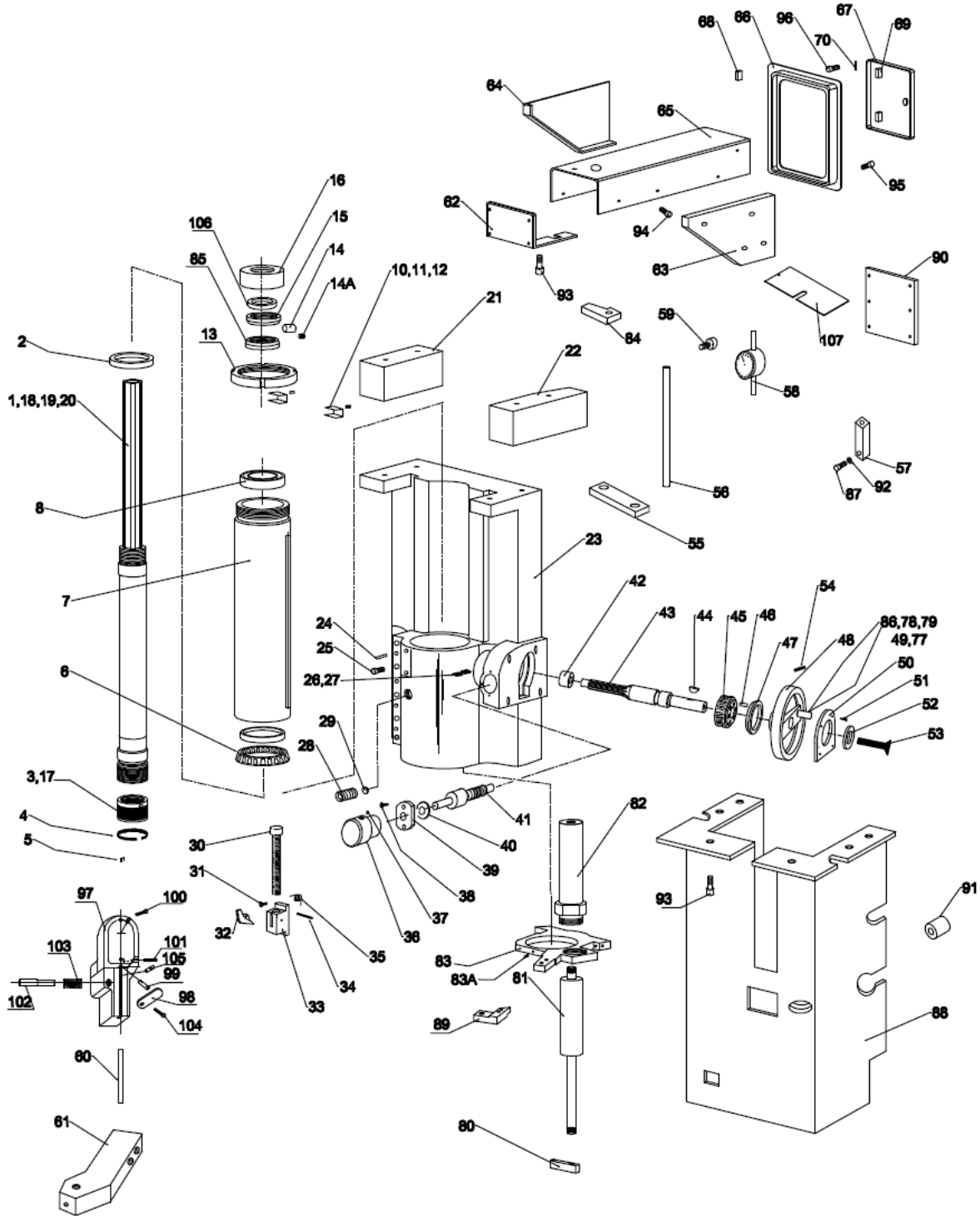

## Spindle Assembly Parts List

S. NO.	PART NO.	DRG. NO.	DESCRIPTION	QTY/M/C
1	430-604 R	8M-131	DRIVE SHAFT	1
2	430-671		RUBBER SEAL (50x70x10)	1
3	KS-08-07	8M-133	QUICK NUT	1
4	KS-08-03		SPRING	2
5	KS-08-02	8M-143	PAD	2
6	430-659		TAPER ROLLER BEARING (40x68x19)	1
7	430-608	8M-132	COLUMN	1
8	430-648		BALL BEARING (40x68x15)	1
9				
10	NC-32	8M-159	BRASS PAD	2
11	430-623A		C.PT. GRUB SCR. (M5x16)	2
12	430-623B		F.PT GRUB SCR. (M5x6)	2
13	NC-33	8M-160	STOP PLATE LOCK NUT	1
14	430-603A		GRUB SCREW (M6x6)	2
14A	430-603B	8M-161	PLUG	2
15	430-603	8M-144	LOCK NUT	1
16	430-601	8M-188	END STOPPER	1
17	KS-08-06	8M-162	COVER	1
18	KS-08-05	8M-189	PIN	1
19	KS-08-04		SPRING	1
20	KS-08-01	8M-163	STOP PIN	1
21	430-711	8M-164	EXTENSION BLOCK LEFT	1
22	430-716-III	8M-165	EXTENSION BLOCK RIGHT	1
23	430-614	8M-134	SPINDLE HOUSING	1
23A	430-614S	8M-196	SHIPPING CLAMP	1
24	430-627		GRUB SCR. D.PT. (M8x25)	4
25	430-609		ALLEN SCREW (M8x30)	4
26	430-621		GRUB. SCR. D. PT. (M8x12)( $\phi$ 0.245"x0.180")	1
27	430-621a		GRUB SCR. F. PT. (M8x8)	1
28	430-619		GRUB SCREW (M10x10)	1
29	430-619A	8M-166	BRASS PLUG ( $\phi$ 0.320"x0.100" LONG)	1
30	430-615 (A & B)	8M-145	CONTROL STOP SCREW ASSY.	1 EACH
31	430-607		C'SINK SCR. (M6x15)	2
32	430-620	8M-146	CONTROL STOP LATCH	1
33	430-606-S	8M-147	STOP ROD BLOCK	1
34	430-617	8M-167	PIN (3/16x3/4)	1
35	430-618		SPRING	1
36	430-664-II	8M-168	KNOB	1
37	430-665		SET SCR. F. PT. (M6x6)	1
38			C' SINK SCR. (M5x12)	2
39	430-663	8M-169	END COVER	1
40	430-662	8M-158	WASHER	1
41	430-660-II	8M-135	WORM SHAFT	1
42	430-631A	8M-170	BUSH	1
43	430-631	8M-136	PINION	1
44	430-632		WOODRUF KEY (3/16x $\phi$ 3/4)	1
45	430-661	8M-137	WORM WHEEL	1
46	430-667	8M-171	PIN	2
47	430-634	8M-172	SPACER	1
48	430-635R	8M-148	HAND WHEEL	1

S NO	PART NO	DRG NO	DESCRIPTION	QTY/M/C
49	430-637R	8M-173	KNOB	
50	430-668	8M-197	COVER PLATE	1
51	430-666		BUTTON HEAD SCREW (M5x10)	4
52	430-636	8M-190	WASHER	1
53	430-636A		C'SINK SCR. (M6x12)	1
54	430-639		M4-BALL PLUNGER SCREW	1
55	VGS-641	8M-191	INDICATOR MTG. FLAT	1
56	VGS-642	8M-174	INDICATOR MTG. ROD	1
57	430-643A-II	8M-192	DIAL CLAMP	1
58	VGS-646		INDICATOR	1
59	430-645A		KNOB	1
60	430-616	8M-138	LEVELING PIN	1
61	NC-37-1	8M-149	PLATE (LEVELING PIN)	1
62	430-650-II	8M-198	CONTROL PANEL MOUNTING	1
63	430-647a	8M-199	RIGHT SIDE COVER	1
64	430-647b	8M-200	LEFT SIDE COVER	1
65	430-647-C	8M-201	TOP COVER	1
66	430-713	8M-202	BACK COVER FRAME	1
67	430-715	8M-203	BACK DOOR	1
68	430-722	8M-150	FIX BLOCK	2
69	430-723	8M-151	SWING BLOCK	2
70	430-724	8M-175	PIN (3/16x3/4 SS)	2
71				
72				
73				
74				
75				
76				
77	430-677		ALLEN HEAD BOLT (M8x65)	1
78	430-678		C-SINK SCREW (M6x12)	1
79	430-679		GRUB SCREW (M6x6)	1
80	430-712-R	8M-176	HOLDER	1
81	430-714-R		GAS SPRING (150N)	1
82	430-717-R	8M-177	TUBE	1
83	430-625-R-II	8M-152	PLATE	1
83A			GRUB SCREW (M5x8)	1
84	430-643 B	8M-193	CLAMP	1
85	430-605	8M-178	SPACER	1
86	430-638 R	8M-179	PLUG (LEVER)	1
87			<b>ALLEN HEAD SCREW (M6x20)</b>	1
88	NC-40-2	8M-204	FRONT COVER	1
89	430-625R-III	8M-180	SUPPORT BRACKET	1
90	430-PP1-1	8M-205	PANEL PLATE	1
91	<b>NC-40-A</b>		<b>SPACER</b>	<b>2</b>
92	<b>VGS-646-1</b>	<b>8M-195</b>	<b>WASHER</b>	<b>1</b>
93			BUTTON HEAD SCREW (M6x12)	8
94			BUTTON HEAD SCREW (M5x12)	27
95			C'SINK SCREW (M5x12)	4
96			ALLEN HEAD SCREW (M5x20)	1
97	430-1049 B	8M-153	LEVEL BLOCK	1
98	430-1025	8M-207	CLAMP	1
S.	PART NO.	DRG. NO.	DESCRIPTION	QTY/M/C

<b>NO.</b>				
<b>99</b>			GRUB SCREW (M5 x 16)	1
<b>100</b>			ALLEN HEAD SCREW (M3 x 12)	2
<b>101</b>			DOWEL PIN (Ø3/16 x 3/4 LONG)	1
<b>102</b>	430-1026	8M-181	CLAMP PIN	1
<b>103</b>	430-1026-1		SPRING	1
<b>104</b>			BUTTON HEAD (SCREW M5 x 10)	1
<b>105</b>	430-1049C	8M-182	SLIDE PIN	1
<b>106</b>	430-601-A	8M-183	SPACER	1
<b>107</b>	NC-131-1	8M-206	BOTTOM COVER	1



### Transmission Assembly

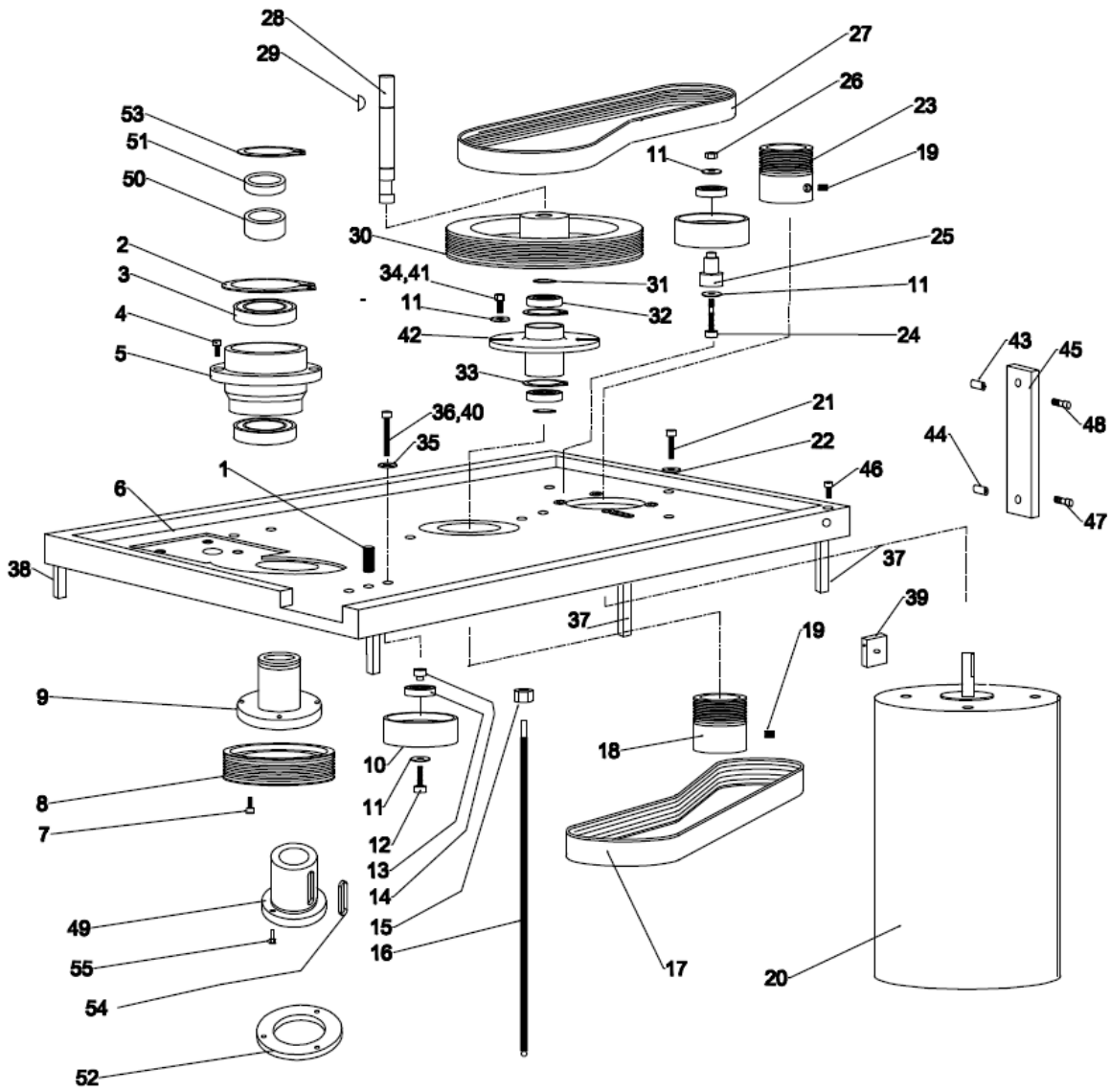

**Transmission Assembly Parts List**

S. NO.	PART NO.	DRG. NO.	DESCRIPTION	QTY/M/C
1			DOWEL PIN (Ø10x80MM)	2
2	<b>NC-155</b>		<b>EXT. CIRCLIP (Ø50)</b>	<b>1</b>
3			BALL BEARING (61910-2RS1)	2
4	430-705A		ALLEN SCREW(M6x16)	6
5	430-705-I	8M-226	BEARING HOUSING	1
6	430-735	8M-221	PLATE	1
7	VGS-703		ALLEN SCREW (M5x12)	4
8	430-702	8M-227	DRIVE PULLEY	1
9	430-701-II	8M-222	FLANGE	1
10	VGS-707	8M-245	IDLER PULLEY	2
11	VGS-740	8M-228	WASHER	5
12	VGS-706-C		ALLEN SCREW (M6x35)	1
13	VGS-708		BEARING (6200 2 Z)	2
14	VGS-709	8M-229	IDLER HUB	1
15	VGS-725		HEX NUT (1/2"-20 NF)	1
16	430-721	8M-230	MOTOR CONTROL SUPPORT	1
17	VGS-710		V-BELT (COUNTER SHAFT) (220-J 10)	1
18	VGS-751	8M-231	PULLEY	1
19	VGS-753		GRUB SCR. F. PT. (M6x8)	3
20	430-726		MOTOR DC 1HP (CDP 3455)	1
21	VGS-731		ALLEN SCR.(3/8x1 ¼")	4
22	VGS-732		WASHER	4
23	430-738	8M-232	PULLEY	1
24	430-706A		ALLEN SCREW (M6x75)	1
25	430-709A	8M-246	IDLER HUB	1
26	430-706B		HEX NUT (M6)	1
27	VGS-737		V-BELT (DRIVE) (300-J-10))	1
28	430-746	8M-233	SHAFT	1
29	VGS-742		WOODRUF KEY 3/16" X 3/4" DIA	2
30	430-741	8M-234	PULLEY	1
31	VGS-745		EXT. CIRCLIP	2
32	VGS-743		BEARING (R10-2 Z)	2
33	VGS-744		INT. CIRCLIP	2
34	VGS-739		ALLEN HEAD SCREW (M6x25)	1
35			SPRING WASHER (M8)	4
36			ALLEN SCREW (M8x70)	4
37	430-718	8M-247	COVER SUPPORT	4
38	430-719	8M-235	COVER SUPPORT	2
39	430-720	8M-236	COVER SUPPORT	6
40	430-735W	8M-237	SPACER ( NOT SHOWN)	4
41			ALLEN HEAD SCREW (M6x20)	1
42	VGS-747	8M-238	FLANGE	1
43	430-PP-8	8M-239	SMALL SPACER	2
44	430-PP-9	8M-240	LARGE SPACER	2
45	430-PP-13	8M-241	SHIPPING CLAMP	2
46			ALLEN HEAD SCREW (M6x25)	6
47			ALLEN HEAD SCREW (M8x70)	2
48			ALLEN HEAD SCREW (M8x30)	2
<b>49</b>	<b>430-701-1</b>		<b>SPLINE BUSH</b>	<b>1</b>
<b>50</b>	<b>430-727</b>		<b>SPACER</b>	<b>1</b>
<b>51</b>	<b>430-728</b>		<b>LOCATING BUSH</b>	<b>1</b>

<b>S NO</b>	<b>PART NO</b>	<b>DRWG NO</b>	<b>PART DESCRIPTION</b>	<b>QTY/M/C</b>
52	430-733		END STOPPER RING	1
53	430-730		INTERNAL CIRCLIP 1-1/2"	1
54	NC-156		KEY 1/4x1-1/4	1
55			ALLEN HEAD SCREW M4x16	4

# HEAD SUPPORT ASSEMBLY

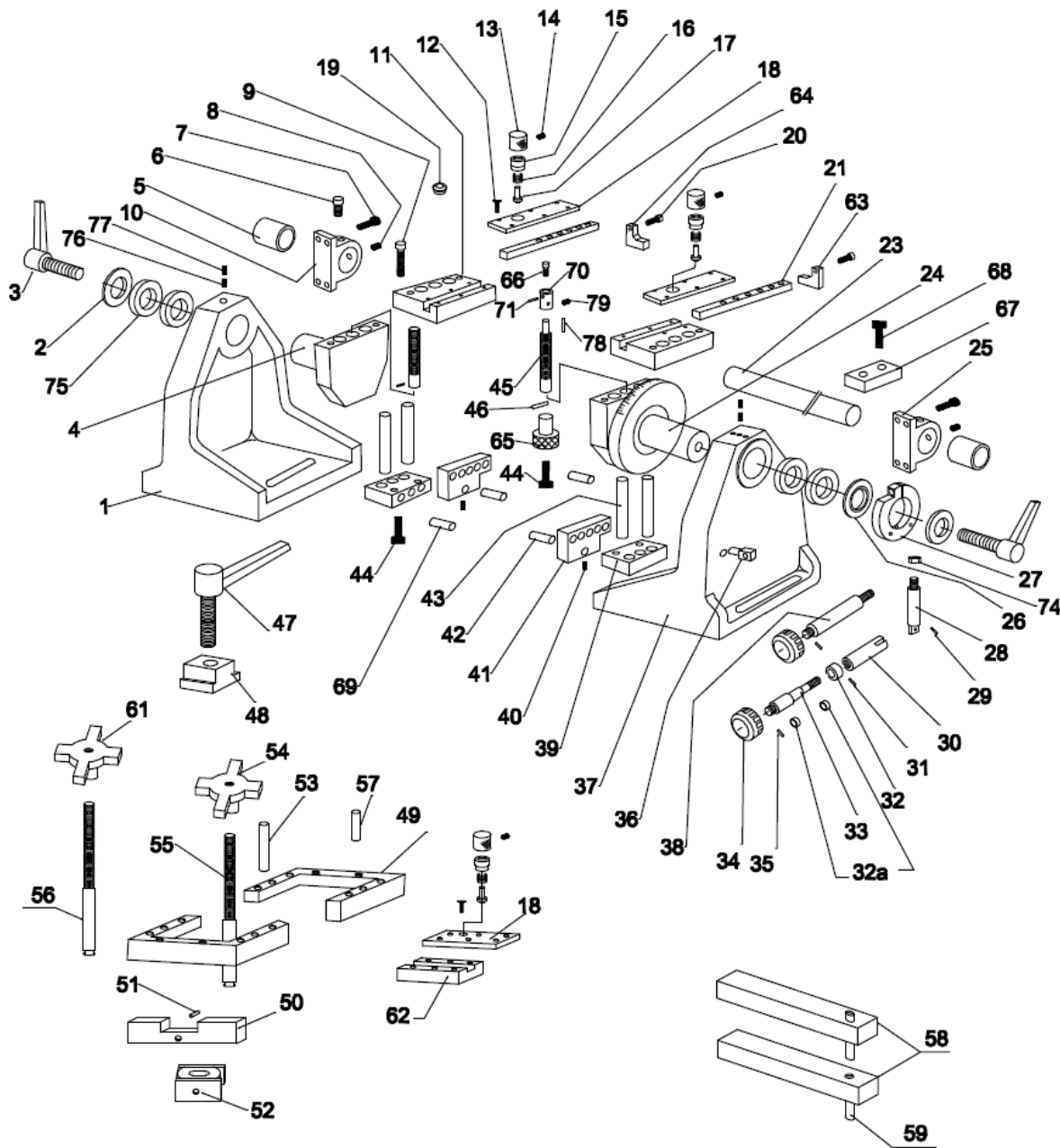

**HEAD SUPPORT ASSEMBLY PARTS LIST**

S. NO.	PART NO.	DRG. NO.	DESCRIPTION	QTY/M/C
1	430-913-A	8M-261	HEAD SUPPORT LEFT	1
2	430-912	8M-287	WASHER	2
3	430-938 A & C	8M-318	CLAMP BOLT L.H & R.H.	2 EACH
3A	430-938 B	8M-320	WASHER	4
3B	430-938 D	<b>8M-319</b>	PIN	4
4	SF-113	8M-262	HOLDER LEFT	1
5	430-901	8M-272	BUSH	2
6	430-911	8M-288	KNOB	1
7	430-906		ALLEN HEAD BOLT (M8x20)	8
8			GRUB SCREW (M8x10)	2
9	VGS-959		ALLEN HEAD BOLT (M10x35 LONG)	4
10	430-902	8M-289	BEARING BUSH LEFT	1
11	SF-101	8M-273	PLATE	2
12	430-925		C <sup>o</sup> SINK SCREW (M5x12)	24
13	430-918	8M-290	KNURLING COLLAR	4
14	430-917		GRUB SCREW (M6x6)	4
15	430-916	8M-291	PIN HOLDER	4
16	430-921		SPRING (SAME AS #100-057)	4
17	430-919	8M-292	PLUNGER	4
18	430-915	8M-293	PLATE	4
19	<b>VGS-960</b>		<b>CAP (BLACK)</b>	<b>4</b>
20	430-936		ALLEN HEAD SCREW (M6x20)	2
21	SF-108	8M-274	FLAT	2
22	-----		-----	---
23	430-914	8M-294	GUIDE ROD	1
24	SF-112	8M-263	HOLDER RIGHT	1
25	430-907	8M-295	BEARING BUSH RIGHT	1
26	430-934	8M-296	SPACER	1
27	430-933	8M-275	COLLAR	1
28	430-929	8M-297	ARM	1
29	VGS-928	8M-298	PIN (1/8"x5/8")	1
30	430-927	8M-299	CLAMP	1
31	430-904		ROLL PIN (1/8"x3/4")	1
32	430-548	8M-90	RETAINING RING	1
32A	430-550		THRUST BEARING (12x26x4)	2
33	430-926	8M-300	ADJUSTING SCREW	1
34	430-923		KNOB	2
35	430-924	8M-301	PIN (1/8" x1 1/16")	2
36	430-922	8M-302	PIVOT BLOCK	1
37	430-920-A	8M-264	HEAD SUPPORT RIGHT	1
38	430-931	8M-303	LOCK COLLAR SCREW	1
39	SF-104	8M-276	CLAMP PLATE	2
40			GRUB SCREW (M5x6)	2
41	430-964-1	8M-277	CLAMP	2
42	430-949	8M-304	PIVOT PIN	2
43	430-961	8M-305	GUIDE PIN	4
44	430-967		ALLEN HD. SCREW (M12x50)	2
45	SF-103	8M-278	SCREW	2
46	VGS-963	8M-306	PIN (5/32"x5/8" LONG)	4
47	430-941		HANDLE	4

S. NO.	PART NO.	DRG. NO.	DESCRIPTION	QTY/M/C
48	430-939	8M-307	T-NUT	2
49	SF-110	8M-279	HEAD SUPPORT	2
50	430-945	8M-308	BAR	2
51	430-946		ROLL PIN (1/4"x1 1/4")	2
52	430-947	8M-271	SWIVEL CLAMP	2
53	430-943	8M-326	TUBE	2
54	430-942	8M-309	KNOB	2
55	430-948	8M-310	TAKE UP ROD	2
56	430-948A	8M-311	TAKE UP ROD ( 1/4" )	2
57	430-943S	8M-327	TUBE (SMALL)	2
58	430-944S	8M-312	PARALLEL FLAT	2
59			DOWEL PIN (1/4" X 1") (PURCHASED)	2
60	430-965-1	8M-321	CLAMPING PIN (NOT SHOWN)	4
61	430-942-A	8M-313	KNOB (1/4")	2
62	430-944-II	8M-280	LOCATING BLOCK	2
63	430-935-I	8M-281	STOP PLATE R. H.	1
64	430-937-I	8M-282	STOP PLATE L. H.	1
65	430-962-2	8M-314	KNOB	2
66			ALLEN HEAD SCREW (M12x25)	2
67	NC-105	8M-283	LOCATING BLOCK	1
68			SCREW (M6x16)	2
69	NC-59B	8M-315	ALIGNMENT BAR	2
70	SF-107	8M-316	TOMMY NUT	2
71	SF-130	8M-317	PIN Ø0.156"x0.970" LONG	2
72				
73				
74			NUT M10	1
75	<b>430-950</b>		<b>NEEDLE ROLLER BEARING</b>	<b>4</b>
76	<b>430-951</b>	<b>8M-328</b>	<b>SETTING SCREW</b>	<b>2</b>
77	<b>430-952</b>		<b>GRUB SCREW M8x10</b>	<b>2</b>
78	<b>430-953</b>		<b>KEY</b>	<b>2</b>
79	<b>430-954</b>		<b>GRUB SCREW M6x6</b>	<b>2</b>

# Wiring Diagram

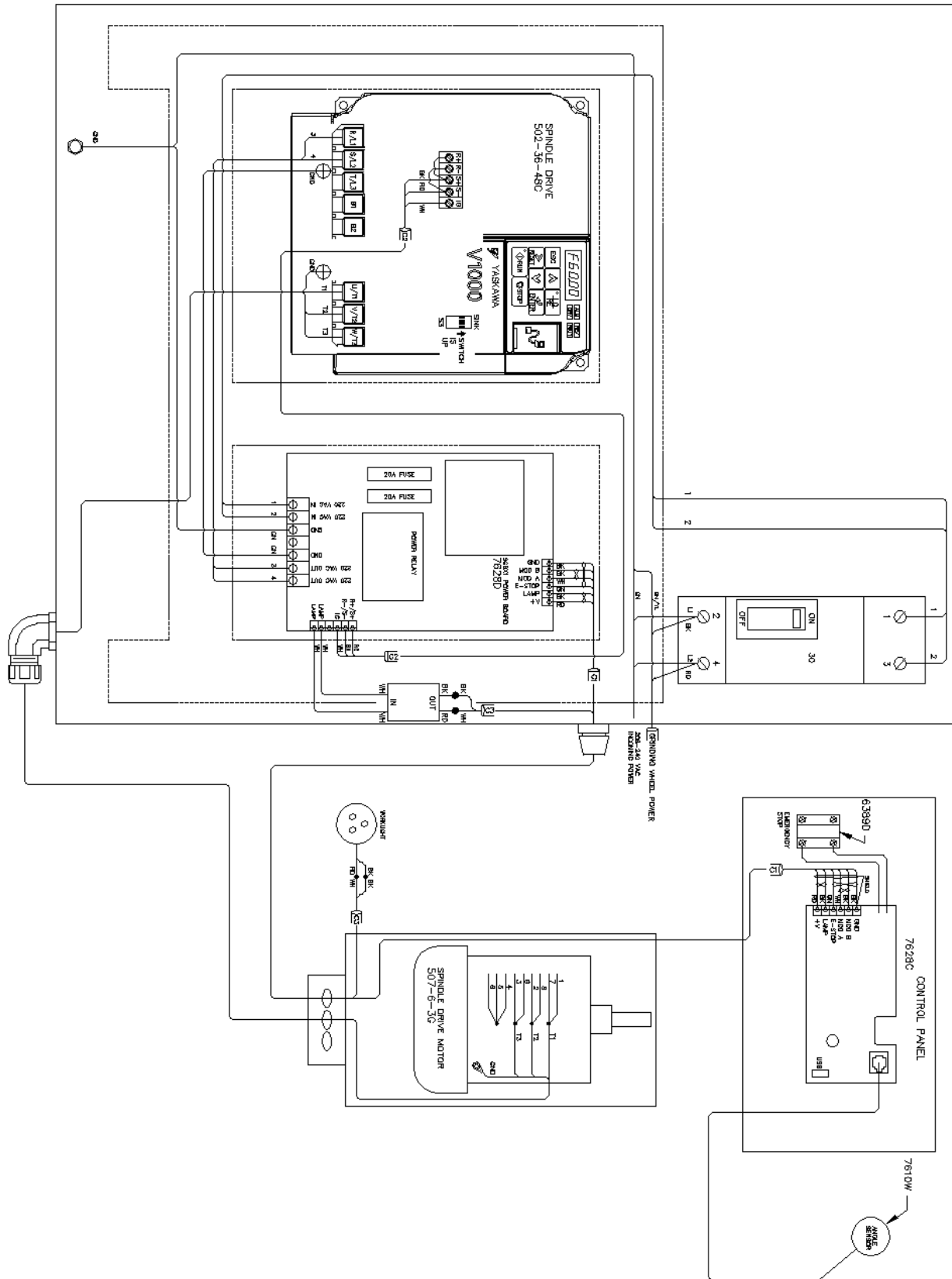

### Pneumatic Drawing

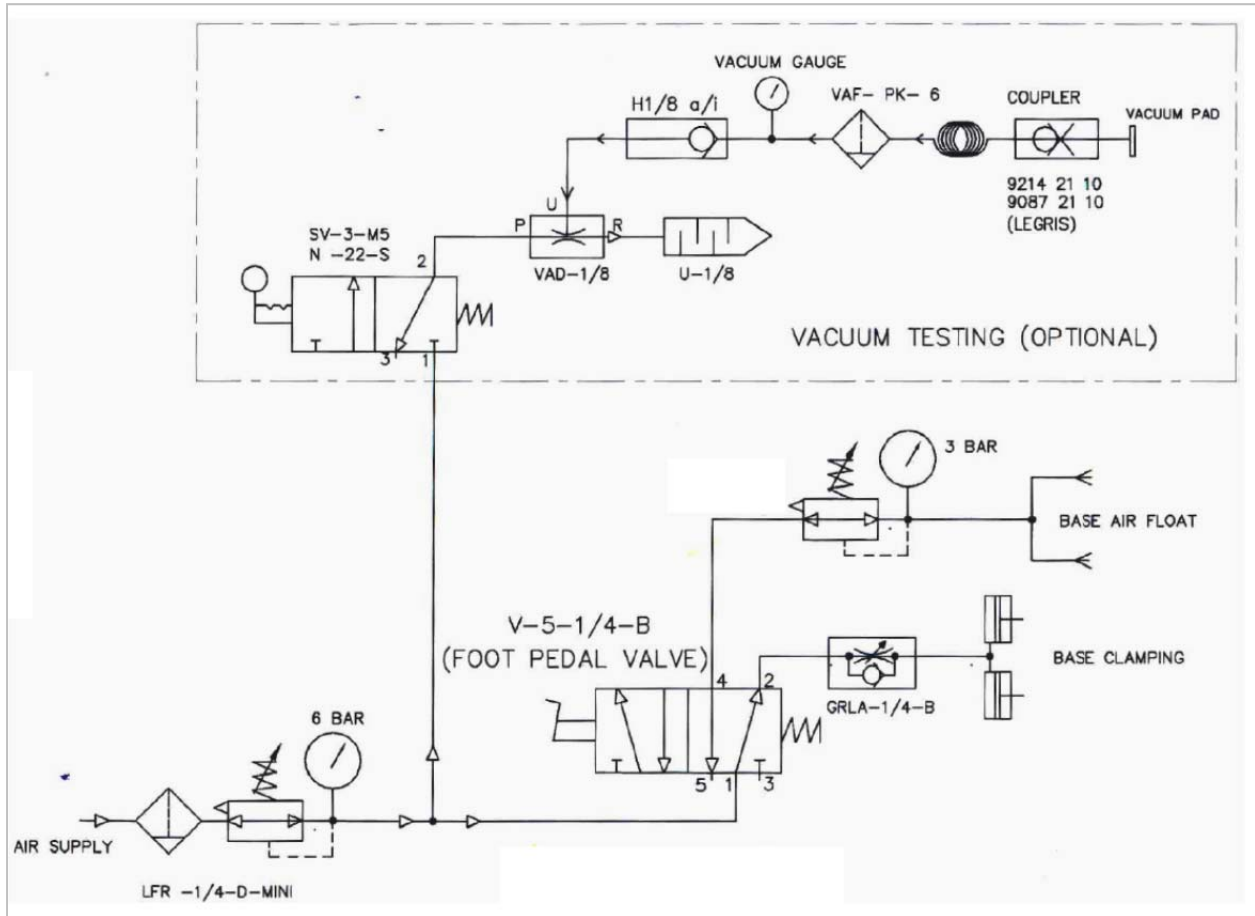



## DECIMAL TO METRIC CONVERSION CHART

### Units of Length

To Convert	Multiply by	To Obtain
mm	0.03937	in.
cm	0.3937	in.
meters	39.37	in.
meters	3.281	ft.
meters	1.0936	yd.
km	3,281	ft.

To Convert	Multiply by	To Obtain
km	1093.6	yd.
km	0.6214	miles
microns	0.00003937	in.
in.	25.4	mm
in.	2.54	cm
in.	0.0254	meters

To Convert	Multiply by	To Obtain
ft.	0.3048	meters
ft.	0.0003048	km
yd.	0.9144	meters
yd.	0.0009144	km
miles	1.609	km
in.	25,400	microns

fraction	decimal	mm
1/64	0.0156	0.3969
1/32	0.0313	0.7938
3/64	0.0469	1.1906
1/16	0.0625	1.5875
5/64	0.0781	1.9844
3/32	0.0938	2.3813
7/64	0.1094	2.7781
<b>1/8</b>	<b>0.1250</b>	<b>3.1750</b>
9/64	0.1406	3.5719
5/32	0.1563	3.9688
11/64	0.1719	4.3656
3/16	0.1875	4.7625
13/64	0.2031	5.1594
7/32	0.2188	5.5563
15/64	0.2344	5.9531
<b>1/4</b>	<b>0.2500</b>	<b>6.3500</b>
17/64	0.2656	6.7469
9/32	0.2813	7.1438
19/64	0.2969	7.5406
5/16	0.3125	7.9375
21/64	0.3281	8.3344
11/32	0.3438	8.7313
23/64	0.3594	9.1281
<b>3/8</b>	<b>0.3750</b>	<b>9.5250</b>
25/64	0.3906	9.9219
13/32	0.4063	10.3188
27/64	0.4219	10.7156
7/16	0.4375	11.1125
29/64	0.4531	11.5094
15/32	0.4688	11.9063

fraction	decimal	mm
1 1/64	1.0156	25.7969
1 1/32	1.0313	26.1938
1 3/64	1.0469	26.5906
1 1/16	1.0625	26.9875
1 5/64	1.0781	27.3844
1 3/32	1.0938	27.7813
1 7/64	1.1094	28.1781
<b>1 1/8</b>	<b>1.1250</b>	<b>28.5750</b>
1 9/64	1.1406	28.9719
1 5/32	1.1563	29.3688
1 11/64	1.1719	29.7656
1 3/16	1.1875	30.1625
1 13/64	1.2031	30.5594
1 7/32	1.2188	30.9563
1 15/64	1.2344	31.3531
<b>1 1/4</b>	<b>1.2500</b>	<b>31.7500</b>
1 17/64	1.2656	32.1469
1 9/32	1.2813	32.5438
1 19/64	1.2969	32.9406
1 5/16	1.3125	33.3375
1 21/64	1.3281	33.7344
1 11/32	1.3438	34.1313
1 23/64	1.3594	34.5281
<b>1 3/8</b>	<b>1.3750</b>	<b>34.9250</b>
1 25/64	1.3906	35.3219
1 13/32	1.4063	35.7188
1 27/64	1.4219	36.1156
1 7/16	1.4375	36.5125
1 29/64	1.4531	36.9094
1 15/32	1.4688	37.3063

fraction	decimal	mm
2 1/64	2.0156	51.1969
2 1/32	2.0313	51.5938
2 3/64	2.0469	51.9906
2 1/16	2.0625	52.3875
2 5/64	2.0781	52.7844
2 3/32	2.0938	53.1813
2 7/64	2.1094	53.5781
<b>2 1/8</b>	<b>2.1250</b>	<b>53.9750</b>
2 9/64	2.1406	54.3719
2 5/32	2.1563	54.7688
2 11/64	2.1719	55.1656
2 3/16	2.1875	55.5625
2 13/64	2.2031	55.9594
2 7/32	2.2188	56.3563
2 15/64	2.2344	56.7531
<b>2 1/4</b>	<b>2.2500</b>	<b>57.1500</b>
2 17/64	2.2656	57.5469
2 9/32	2.2813	57.9438
2 19/64	2.2969	58.3406
2 5/16	2.3125	58.7375
2 21/64	2.3281	59.1344
2 11/32	2.3438	59.5313
2 23/64	2.3594	59.9281
<b>2 3/8</b>	<b>2.3750</b>	<b>60.3250</b>
2 25/64	2.3906	60.7219
2 13/32	2.4063	61.1188
2 27/64	2.4219	61.5156
2 7/16	2.4375	61.9125
2 29/64	2.4531	62.3094
2 15/32	2.4688	62.7063

31/64	0.4844	12.3031
<b>1/2</b>	<b>0.5000</b>	<b>12.7000</b>
33/64	0.5156	13.0969
17/32	0.5313	13.4938
35/64	0.5469	13.8906
9/16	0.5625	14.2875
37/64	0.5781	14.6844
19/32	0.5938	15.0813
39/64	0.6094	15.4781
<b>5/8</b>	<b>0.6250</b>	<b>15.8750</b>
41/64	0.6406	16.2719
21/32	0.6563	16.6688
43/64	0.6719	17.0656
11/16	0.6875	17.4625
45/64	0.7031	17.8594
23/32	0.7188	18.2563
47/64	0.7344	18.6531
<b>3/4</b>	<b>0.7500</b>	<b>19.0500</b>
49/64	0.7656	19.4469
25/32	0.7813	19.8438
51/64	0.7969	20.2406
13/16	0.8125	20.6375
53/64	0.8281	21.0344
27/32	0.8438	21.4313
55/64	0.8594	21.8281
<b>7/8</b>	<b>0.8750</b>	<b>22.2250</b>
57/64	0.8906	22.6219
29/32	0.9063	23.0188
59/64	0.9219	23.4156
15/16	0.9375	23.8125
61/64	0.9531	24.2094
31/32	0.9688	24.6063
63/64	0.9844	25.0031
<b>1</b>	<b>1.0000</b>	<b>25.4000</b>

1 31/64	1.4844	37.7031
<b>1 1/2</b>	<b>1.5000</b>	<b>38.1000</b>
1 33/64	1.5156	38.4969
1 17/32	1.5313	38.8938
1 35/64	1.5469	39.2906
1 9/16	1.5625	39.6875
1 37/64	1.5781	40.0844
1 19/32	1.5938	40.4813
1 39/64	1.6094	40.8781
<b>1 5/8</b>	<b>1.6250</b>	<b>41.2750</b>
1 41/64	1.6406	41.6719
1 21/32	1.6563	42.0688
1 43/64	1.6719	42.4656
1 11/16	1.6875	42.8625
1 45/64	1.7031	43.2594
1 23/32	1.7188	43.6563
1 47/64	1.7344	44.0531
<b>1 3/4</b>	<b>1.7500</b>	<b>44.4500</b>
1 49/64	1.7656	44.8469
1 25/32	1.7813	45.2438
1 51/64	1.7969	45.6406
1 13/16	1.8125	46.0375
1 53/64	1.8281	46.4344
1 27/32	1.8438	46.8313
1 55/64	1.8594	47.2281
<b>1 7/8</b>	<b>1.8750</b>	<b>47.6250</b>
1 57/64	1.8906	48.0219
1 29/32	1.9063	48.4188
1 59/64	1.9219	48.8156
1 15/16	1.9375	49.2125
1 61/64	1.9531	49.6094
1 31/32	1.9688	50.0063
1 63/64	1.9844	50.4031
<b>2</b>	<b>2.0000</b>	<b>50.8000</b>

2 31/64	2.4844	63.1031
<b>2 1/2</b>	<b>2.5000</b>	<b>63.5000</b>
2 33/64	2.5156	63.8969
2 17/32	2.5313	64.2938
2 35/64	2.5469	64.6906
2 9/16	2.5625	65.0875
2 37/64	2.5781	65.4844
2 19/32	2.5938	65.8813
2 39/64	2.6094	66.2781
<b>2 5/8</b>	<b>2.6250</b>	<b>66.6750</b>
2 41/64	2.6406	67.0719
2 21/32	2.6563	67.4688
2 43/64	2.6719	67.8656
2 11/16	2.6875	68.2625
2 45/64	2.7031	68.6594
2 23/32	2.7188	69.0563
2 47/64	2.7344	69.4531
<b>2 3/4</b>	<b>2.7500</b>	<b>69.8500</b>
2 49/64	2.7656	70.2469
2 25/32	2.7813	70.6438
2 51/64	2.7969	71.0406
2 13/16	2.8125	71.4375
2 53/64	2.8281	71.8344
2 27/32	2.8438	72.2313
2 55/64	2.8594	72.6281
<b>2 7/8</b>	<b>2.8750</b>	<b>73.0250</b>
2 57/64	2.8906	73.4219
2 29/32	2.9063	73.8188
2 59/64	2.9219	74.2156
2 15/16	2.9375	74.6125
2 61/64	2.9531	75.0094
2 31/32	2.9688	75.4063
2 63/64	2.9844	75.8031
<b>3</b>	<b>3.0000</b>	<b>76.2000</b>

## **Options**

**Options and Tooling are in separate manuals.**



# Safety Data Sheet



## Section 1: Identification of the substance or mixture and of the supplier

**Product Name:** Multi-Way Oil HD  
**SDS Number:** 817776

**Synonyms/Other Means of Identification:** Multi-Way HD 32  
Multi-Way HD 68  
Multi-Way HD 220

**Intended Use:** Way Oil

**Manufacturer:** Phillips 66 Lubricants  
600 N. Dairy Ashford, 2WL9072F  
Houston, Texas 77079-1175

**Emergency Health and Safety Number:** Chemtrec: 800-424-9300 (24 Hours)

**Customer Service:** U.S.: 1-800-822-6457 or International: +1-83-2486-3363

**Technical Information:** 1-877-445-9198

**SDS Information:** Phone: 800-762-0942  
Email: SDS@P66.com  
URL: www.Phillips66.com

## Section 2: Hazard(s) Identification

This material is not considered hazardous according to OSHA criteria.



## Section 3: Composition / Information on Ingredients

Component	CASRN	Concentration <sup>1</sup>
Lubricant Base Oil (Petroleum)	VARIOUS	>95
Additives	Proprietary	<5

<sup>1</sup> All concentrations are percent by weight unless ingredient is a gas. Gas concentrations are in percent by volume.

## Section 4: First Aid Measures

**Eye Contact:** If irritation or redness develops from exposure, flush eyes with clean water. If symptoms persist, seek medical attention.

**Skin Contact:** Remove contaminated shoes and clothing and cleanse affected area(s) thoroughly by washing with mild soap and water or a waterless hand cleaner. If irritation or redness develops and persists, seek medical attention.

**Inhalation (Breathing):** First aid is not normally required. If breathing difficulties develop, move victim away from source of exposure and into fresh air in a position comfortable for breathing. Seek immediate medical attention.

**Ingestion (Swallowing):** First aid is not normally required; however, if swallowed and symptoms develop, seek medical attention.

**Notes to Physician:** Acute aspirations of large amounts of oil-laden material may produce a serious aspiration pneumonia. Patients who aspirate these oils should be followed for the development of long-term sequelae. Inhalation exposure to oil mists below current workplace exposure limits is unlikely to cause pulmonary abnormalities.

**Medical Conditions Aggravated by Exposure:** Conditions which may be aggravated by exposure include skin disorders.

## Section 5: Fire-Fighting Measures

### NFPA 704 Hazard Class

**Health:** 0   **Flammability:** 1   **Instability:** 0   (0-Minimal, 1-Slight, 2-Moderate, 3-Serious, 4-Severe)

**Unusual Fire & Explosion Hazards:** This material may burn, but will not ignite readily. If container is not properly cooled, it can rupture in the heat of a fire.

**Extinguishing Media:** Dry chemical, carbon dioxide, foam, or water spray is recommended. Water or foam may cause frothing of materials heated above 212°F / 100°C. Carbon dioxide can displace oxygen. Use caution when applying carbon dioxide in confined spaces. Simultaneous use of foam and water on the same surface is to be avoided as water destroys the foam.

**Fire Fighting Instructions:** For fires beyond the initial stage, emergency responders in the immediate hazard area should wear protective clothing. When the potential chemical hazard is unknown, in enclosed or confined spaces, a self contained breathing apparatus should be worn. In addition, wear other appropriate protective equipment as conditions warrant (see Section 8).

Isolate immediate hazard area and keep unauthorized personnel out. Stop spill/release if it can be done safely. Move undamaged containers from immediate hazard area if it can be done safely. Water spray may be useful in minimizing or dispersing vapors and to protect personnel. Cool equipment exposed to fire with water, if it can be done safely. Avoid spreading burning liquid with water used for cooling purposes.

**Hazardous Combustion Products:** Combustion may yield smoke, carbon monoxide, and other products of incomplete combustion. Oxides of sulfur, nitrogen or phosphorus may also be formed.

See Section 9 for Flammable Properties including Flash Point and Flammable (Explosive) Limits

## Section 6: Accidental Release Measures

**Personal Precautions:** This material may burn, but will not ignite readily. Keep all sources of ignition away from spill/release. Stay upwind and away from spill/release. Avoid direct contact with material. For large spillages, notify persons down wind of the spill/release, isolate immediate hazard area and keep unauthorized personnel out. Wear appropriate protective equipment, including respiratory protection, as conditions warrant (see Section 8). See Sections 2 and 7 for additional information on hazards and precautionary measures.

**Environmental Precautions:** Stop spill/release if it can be done safely. Prevent spilled material from entering sewers, storm drains, other unauthorized drainage systems, and natural waterways. Use water sparingly to minimize environmental contamination and reduce disposal requirements. If spill occurs on water notify appropriate authorities and advise shipping of any hazard. Spills into or upon navigable waters, the contiguous zone, or adjoining shorelines that cause a sheen or discoloration on the surface of the water, may require notification of the National Response Center (phone number 800-424-8802). If spill/release in excess of EPA reportable quantity (see Section 15) is made into the environment, immediately notify the National Response Center (phone number 800-424-8802).

**Methods for Containment and Clean-Up:** Notify relevant authorities in accordance with all applicable regulations. Immediate cleanup of any spill is recommended. Dike far ahead of spill for later recovery or disposal. Absorb spill with inert material such as sand or vermiculite, and place in suitable container for disposal. If spilled on water remove with appropriate methods (e.g. skimming, booms or absorbents). In case of soil contamination, remove contaminated soil for remediation or disposal, in accordance with local regulations.

Recommended measures are based on the most likely spillage scenarios for this material; however local conditions and regulations may influence or limit the choice of appropriate actions to be taken. See Section 13 for information on appropriate disposal.

## Section 7: Handling and Storage

**Precautions for safe handling:** Keep away from flames and hot surfaces. Wash thoroughly after handling. Use good personal hygiene practices and wear appropriate personal protective equipment (see section 8).

Spills will produce extremely slippery surfaces. Do not enter confined spaces such as tanks or pits without following proper entry procedures such as ASTM D-4276 and 29CFR 1910.146. Do not wear contaminated clothing or shoes.

**Conditions for safe storage:** Keep container(s) tightly closed and properly labeled. Use and store this material in cool, dry, well-ventilated area away from heat and all sources of ignition. Store only in approved containers. Keep away from any incompatible material (see Section 10). Protect container(s) against physical damage.

"Empty" containers retain residue and may be dangerous. Do not pressurize, cut, weld, braze, solder, drill, grind, or expose such containers to heat, flame, sparks, or other sources of ignition. They may explode and cause injury or death. "Empty" drums should be completely drained, properly bunged, and promptly shipped to the supplier or a drum reconditioner. All containers should be disposed of in an environmentally safe manner and in accordance with governmental regulations. Before working on or in tanks which contain or have contained this material, refer to OSHA regulations, ANSI Z49.1, and other references pertaining to cleaning, repairing, welding, or other contemplated operations.

## Section 8: Exposure Controls / Personal Protection

Component	ACGIH	OSHA	Other
Lubricant Base Oil (Petroleum)	TWA: 5mg/m <sup>3</sup> STEL: 10 mg/m <sup>3</sup> as oil mist, if generated	TWA: 5 mg/m <sup>3</sup> as Oil Mist, if generated	---

**Note:** State, local or other agencies or advisory groups may have established more stringent limits. Consult an industrial hygienist or similar professional, or your local agencies, for further information.

**Engineering controls:** If current ventilation practices are not adequate to maintain airborne concentrations below the established exposure limits, additional engineering controls may be required.

**Eye/Face Protection:** The use of eye/face protection is not normally required; however, good industrial hygiene practice suggests the use of eye protection that meets or exceeds ANSI Z.87.1 whenever working with chemicals.

**Skin/Hand Protection:** The use of skin protection is not normally required; however, good industrial hygiene practice suggests the use of gloves or other appropriate skin protection whenever working with chemicals. Suggested protective materials: Nitrile

**Respiratory Protection:** Where there is potential for airborne exposure above the exposure limit a NIOSH certified air purifying respirator equipped with R or P95 filters may be used.

A respiratory protection program that meets or is equivalent to OSHA 29 CFR 1910.134 and ANSI Z88.2 should be followed whenever workplace conditions warrant a respirator's use. Air purifying respirators provide limited protection and cannot be used in atmospheres that exceed the maximum use concentration (as directed by regulation or the manufacturer's instructions), in oxygen deficient (less than 19.5 percent oxygen) situations, or under conditions that are immediately dangerous to life and health (IDLH).

**Suggestions provided in this section for exposure control and specific types of protective equipment are based on readily available information. Users should consult with the specific manufacturer to confirm the performance of their protective equipment. Specific situations may require consultation with industrial hygiene, safety, or engineering professionals.**

## Section 9: Physical and Chemical Properties

**Note:** Unless otherwise stated, values are determined at 20°C (68°F) and 760 mm Hg (1 atm). Data represent typical values and are not intended to be specifications.

<b>Appearance:</b>	Dark amber
<b>Physical Form:</b>	Liquid
<b>Odor:</b>	Petroleum
<b>Odor Threshold:</b>	No data
<b>pH:</b>	Not applicable
<b>Vapor Pressure:</b>	<1 mm Hg
<b>Vapor Density (air=1):</b>	>1
<b>Initial Boiling Point/Range:</b>	No data
<b>Melting/Freezing Point:</b>	No data
<b>Pour Point:</b>	< 5 °F / < -15 °C
<b>Solubility in Water:</b>	Insoluble
<b>Partition Coefficient (n-octanol/water) (Kow):</b>	No data

<b>Specific Gravity (water=1):</b>	0.865 - 0.884 @ 60°F (15.6°C)
<b>Bulk Density:</b>	7.20 - 7.37 lbs/gal
<b>Viscosity:</b>	5 - 20 cSt @ 100°C; 32 - 220 cSt @ 40°C
<b>Evaporation Rate (nBuAc=1):</b>	No data
<b>Flash Point:</b>	> 320 °F / > 160 °C
<b>Test Method:</b>	Pensky-Martens Closed Cup (PMCC), ASTM D93, EPA 1010
<b>Lower Explosive Limits (vol % in air):</b>	No data
<b>Upper Explosive Limits (vol % in air):</b>	No data
<b>Auto-ignition Temperature:</b>	No data

## Section 10: Stability and Reactivity

**Stability:** Stable under normal ambient and anticipated conditions of use.

**Conditions to Avoid:** Extended exposure to high temperatures can cause decomposition. Avoid all possible sources of ignition.

**Materials to Avoid (Incompatible Materials):** Avoid contact with strong oxidizing agents and strong reducing agents.

**Hazardous Decomposition Products:** Not anticipated under normal conditions of use.

**Hazardous Polymerization:** Not known to occur.

## Section 11: Toxicological Information

### Information on Toxicological Effects of Substance/Mixture

<u>Acute Toxicity</u>	<u>Hazard</u>	<u>Additional Information</u>	<u>LC50/LD50 Data</u>
Inhalation	Unlikely to be harmful		>5 mg/L (mist, estimated)
Skin Absorption	Unlikely to be harmful		> 2 g/kg (estimated)
Ingestion (Swallowing)	Unlikely to be harmful		> 5 g/kg (estimated)

**Aspiration Hazard:** Not expected to be an aspiration hazard.

**Skin Corrosion/Irritation:** Not expected to be irritating. Repeated exposure may cause skin dryness or cracking.

**Serious Eye Damage/Irritation:** Not expected to be irritating.

**Signs and Symptoms:** Inhalation of oil mists or vapors generated at elevated temperatures may cause respiratory irritation. Accidental ingestion can result in minor irritation of the digestive tract, nausea and diarrhea.

**Skin Sensitization:** Not expected to be a skin sensitizer.

**Respiratory Sensitization:** No information available.

**Specific Target Organ Toxicity (Single Exposure):** No information available on the mixture, however none of the components have been classified for target organ toxicity (or are below the concentration threshold for classification).

**Specific Target Organ Toxicity (Repeated Exposure):** No information available on the mixture, however none of the components have been classified for target organ toxicity (or are below the concentration threshold for classification).

**Carcinogenicity:** No information available on the mixture, however none of the components have been classified for carcinogenicity (or are below the concentration threshold for classification). A mortality study sponsored by General Motors and the United Auto Workers suggested a link between cutting oils or machining fluids and various forms of cancer (e.g., esophageal, laryngeal, and rectal) The study evaluated workplace exposures from 1940-1984. Since the composition of these materials has changed substantially since 1940, and because the most notable effects were seen among those with work histories dating back to that time, the relevance of these findings to present-day exposures is uncertain. Cutting oils or machining fluids have not been identified as carcinogens by NTP, IARC, or OSHA.

**Germ Cell Mutagenicity:** No information available on the mixture, however none of the components have been classified for germ cell mutagenicity (or are below the concentration threshold for classification).



**Reproductive Toxicity:** No information available on the mixture, however none of the components have been classified for reproductive toxicity (or are below the concentration threshold for classification).

**Information on Toxicological Effects of Components**

**Lubricant Base Oil (Petroleum)**

*Carcinogenicity:* The petroleum base oils contained in this product have been highly refined by a variety of processes including severe hydrocracking/hydroprocessing to reduce aromatics and improve performance characteristics. All of the oils meet the IP-346 criteria of less than 3 percent PAH's and are not considered carcinogens by NTP, IARC, or OSHA.

**Section 12: Ecological Information**

**Toxicity:** All acute aquatic toxicity studies on samples of lubricant base oils show acute toxicity values greater than 100 mg/L for invertebrates, algae and fish. These tests were carried out on water accommodated fractions and the results are consistent with the predicted aquatic toxicity of these substances based on their hydrocarbon compositions. Classification: No classified hazards.

**Persistence and Degradability:** The hydrocarbons in this material are not readily biodegradable, but since they can be degraded by microorganisms, they are regarded as inherently biodegradable.

**Bioaccumulative Potential:** Log Kow values measured for the hydrocarbon components of this material are greater than 5.3, and therefore regarded as having the potential to bioaccumulate. In practice, metabolic processes may reduce bioconcentration.

**Mobility in Soil:** Volatilization to air is not expected to be a significant fate process due to the low vapor pressure of this material. In water, base oils will float and spread over the surface at a rate dependent upon viscosity. There will be significant removal of hydrocarbons from the water by sediment adsorption. In soil and sediment, hydrocarbon components will show low mobility with adsorption to sediments being the predominant physical process. The main fate process is expected to be slow biodegradation of the hydrocarbon constituents in soil and sediment.

**Other Adverse Effects:** None anticipated.

**Section 13: Disposal Considerations**

The generator of a waste is always responsible for making proper hazardous waste determinations and needs to consider state and local requirements in addition to federal regulations.

This material, if discarded as produced, would not be a federally regulated RCRA "listed" hazardous waste and is not believed to exhibit characteristics of hazardous waste. See Sections 7 and 8 for information on handling, storage and personal protection and Section 9 for physical/chemical properties. It is possible that the material as produced contains constituents which are not required to be listed in the MSDS but could affect the hazardous waste determination. Additionally, use which results in chemical or physical change of this material could subject it to regulation as a hazardous waste.

This material under most intended uses would become "Used Oil" due to contamination by physical or chemical impurities. Whenever possible, Recycle used oil in accordance with applicable federal and state or local regulations. Container contents should be completely used and containers should be emptied prior to discard.

**Section 14: Transport Information**

**U.S. Department of Transportation (DOT)**

**Shipping Description:** *Not regulated*  
**Note:** *If shipped by land in a packaging having a capacity of 3,500 gallons or more, the provisions of 49 CFR, Part 130 apply. (Contains oil)*

**International Maritime Dangerous Goods (IMDG)**

**Shipping Description:** *Not regulated*  
**Note:** *U.S. DOT compliance requirements may apply. See 49 CFR 171.22, 23 & 25.*

**International Civil Aviation Org. / International Air Transport Assoc. (ICAO/IATA)**

**UN/ID #:** *Not regulated*  
**Note:** *U.S. DOT compliance requirements may apply. See 49 CFR 171.22, 23 & 24.*

	LTD. QTY	Passenger Aircraft	Cargo Aircraft Only
<b>Packaging Instruction #:</b>	---	---	---
<b>Max. Net Qty. Per Package:</b>	---	---	---

## Section 15: Regulatory Information

### CERCLA/SARA - Section 302 Extremely Hazardous Substances and TPQs (in pounds):

This material does not contain any chemicals subject to the reporting requirements of SARA 302 and 40 CFR 372.

### CERCLA/SARA - Section 311/312 (Title III Hazard Categories)

Acute Health:	No
Chronic Health:	No
Fire Hazard:	No
Pressure Hazard:	No
Reactive Hazard:	No

### CERCLA/SARA - Section 313 and 40 CFR 372:

This material does not contain any chemicals subject to the reporting requirements of SARA 313 and 40 CFR 372.

### EPA (CERCLA) Reportable Quantity (in pounds):

This material does not contain any chemicals with CERCLA Reportable Quantities. This material contains the following chemicals subject to the reporting requirements of 40 CFR 302.4:

### California Proposition 65:

This material does not contain any chemicals which are known to the State of California to cause cancer, birth defects or other reproductive harm at concentrations that trigger the warning requirements of California Proposition 65.

### International Hazard Classification

#### GHS Classification

None

#### Canada:

This product has been classified in accordance with the hazard criteria of the Controlled Products Regulations (CPR) and the MSDS contains all the information required by the Regulations.

#### WHMIS Hazard Class:

None

### National Chemical Inventories

All components are either listed on the US TSCA Inventory, or are not regulated under TSCA

All components are either on the DSL, or are exempt from DSL listing requirements

U.S. Export Control Classification Number: EAR99

## Section 16: Other Information

Date of Issue:	14-Jun-2012
Status:	FINAL
Previous Issue Date:	04-Aug-2011
Revised Sections or Basis for Revision:	Format change Manufacturer (Section 1) Toxicological (Section 11) Regulatory information (Section 15)
SDS Number:	817776

### Guide to Abbreviations:

ACGIH = American Conference of Governmental Industrial Hygienists; CASRN = Chemical Abstracts Service Registry Number; CEILING = Ceiling Limit (15 minutes); CERCLA = The Comprehensive Environmental Response, Compensation, and Liability Act; EPA = Environmental Protection Agency; GHS = Globally Harmonized System; IARC = International Agency for Research on Cancer; INSHT = National Institute for Health and Safety at Work; IOPC = International Oil Pollution Compensation; LEL = Lower Explosive Limit; NE = Not Established; NFPA = National Fire Protection Association; NTP = National Toxicology Program; OSHA = Occupational Safety and Health Administration; PEL = Permissible Exposure Limit (OSHA); SARA = Superfund Amendments and Reauthorization Act; STEL = Short Term Exposure Limit (15 minutes); TLV = Threshold Limit Value (ACGIH); TWA = Time Weighted Average (8 hours); UEL = Upper Explosive Limit; WHMIS = Worker Hazardous Materials Information System (Canada)

**Disclaimer of Expressed and implied Warranties:**

The information presented in this Material Safety Data Sheet is based on data believed to be accurate as of the date this Material Safety Data Sheet was prepared. HOWEVER, NO WARRANTY OF MERCHANTABILITY, FITNESS FOR ANY PARTICULAR PURPOSE, OR ANY OTHER WARRANTY IS EXPRESSED OR IS TO BE IMPLIED REGARDING THE ACCURACY OR COMPLETENESS OF THE INFORMATION PROVIDED ABOVE, THE RESULTS TO BE OBTAINED FROM THE USE OF THIS INFORMATION OR THE PRODUCT, THE SAFETY OF THIS PRODUCT, OR THE HAZARDS RELATED TO ITS USE. No responsibility is assumed for any damage or injury resulting from abnormal use or from any failure to adhere to recommended practices. The information provided above, and the product, are furnished on the condition that the person receiving them shall make their own determination as to the suitability of the product for their particular purpose and on the condition that they assume the risk of their use. In addition, no authorization is given nor implied to practice any patented invention without a license.



# Unoba® EP Grease (All Grades)

## Material Safety Data Sheet

### 1. Product and Company Identification

<b>Product Name:</b>	Unoba® EP Grease (All Grades)
<b>MSDS Number:</b>	722490
<b>Synonyms:</b>	76 Unoba® EP Grease 00 76 Unoba® EP Grease 0 76 Unoba® EP Grease 1 76 Unoba® EP Grease 2 76 Unoba® EP Grease 3
<b>Intended Use:</b>	Lubricating Grease
<b>Manufacturer/Supplier:</b>	ConocoPhillips Lubricants 600 N. Dairy Ashford, 2W900 Houston, Texas 77079-1175
<b>Emergency Health and Safety Number:</b>	Chemtrec: 800-424-9300 (24 Hours)
<b>Customer Service:</b>	U.S.: 888-766-7676 or International: +1-83-2486-3363
<b>Technical Information:</b>	800-435-7761
<b>MSDS Information:</b>	Internet: <a href="http://w3.conocophillips.com/NetMSDS/">http://w3.conocophillips.com/NetMSDS/</a>

### 2. Hazards Identification

<u>Emergency Overview</u>	<u>NFPA</u>
<b>CAUTION!</b>  Eye Irritant	

**Appearance:** Green  
**Physical Form:** Semi-Solid  
**Odor:** Petroleum

#### **Potential Health Effects**

**Eye:** Eye irritant. Contact may cause stinging, watering, redness, and swelling.

**Skin:** Contact may cause mild skin irritation including redness and a burning sensation. Prolonged or repeated contact can defat the skin, causing drying and cracking of the skin, and possibly dermatitis (inflammation). No harmful effects from skin absorption are expected.

**Inhalation (Breathing):** No information available on acute toxicity.

**Ingestion (Swallowing):** No harmful effects expected from ingestion.

**Signs and Symptoms:** Effects of overexposure may include irritation of the digestive tract, nausea and diarrhea. Inhalation of oil mist or vapors at elevated temperatures may cause respiratory irritation.

**Pre-Existing Medical Conditions:** Conditions which may be aggravated by exposure include skin disorders and eye disorders.

See Section 11 for additional Toxicity Information.

### 3. Composition / Information on Ingredients

Component	CASRN	Concentration*
Lubricant Base Oil (Petroleum)	VARIOUS	<90
Additives	PROPRIETARY	>12
Zinc dialkyl dithiophosphate	68649-42-3	<2

\* All concentrations are percent by weight unless ingredient is a gas. Gas concentrations are in percent by volume.

### 4. First Aid Measures

**Eye Contact:** If irritation or redness develops from exposure, flush eyes with clean water. Remove contact lenses if present and easy to do. For direct contact, hold eyelids apart and flush the affected eye(s) with clean water for at least 15 minutes. If irritation persists, seek medical attention.

**Skin Contact:** Remove contaminated shoes and clothing and cleanse affected area(s) thoroughly by washing with mild soap and water or a waterless hand cleaner. If irritation or redness develops and persists, seek medical attention.

**Inhalation (Breathing):** If respiratory symptoms develop, move victim away from source of exposure and into fresh air in a position comfortable for breathing. If symptoms persist, seek medical attention.

**Ingestion (Swallowing):** First aid is not normally required; however, if swallowed and symptoms develop, seek medical attention.

**Notes to Physician:** High-pressure hydrocarbon injection injuries may produce substantial necrosis of underlying tissue despite an innocuous appearing external wound. Often these injuries require extensive emergency surgical debridement and all injuries should be evaluated by a specialist in order to assess the extent of injury.

### 5. Fire-Fighting Measures

#### NFPA 704 Hazard Class

**Health:** 1    **Flammability:** 1    **Instability:** 0            (0-Minimal, 1-Slight, 2-Moderate, 3-Serious, 4-Severe)

**Unusual Fire & Explosion Hazards:** This material may burn, but will not ignite readily. If container is not properly cooled, it can rupture in the heat of a fire.

**Extinguishing Media:** Dry chemical, carbon dioxide, foam, or water spray is recommended. Water or foam may cause frothing of materials heated above 212°F. Carbon dioxide can displace oxygen. Use caution when applying carbon dioxide in confined spaces.

**Fire Fighting Instructions:** For fires beyond the incipient stage, emergency responders in the immediate hazard area should wear protective clothing. When the potential chemical hazard is unknown, in enclosed or confined spaces, a self contained breathing apparatus should be worn. In addition, wear other appropriate protective equipment as conditions warrant (see Section 8).

Isolate immediate hazard area and keep unauthorized personnel out. Stop spill/release if it can be done safely. Move undamaged containers from immediate hazard area if it can be done safely. Water spray may be useful in minimizing or dispersing vapors and to protect personnel. Cool equipment exposed to fire with water, if it can be done safely. Avoid spreading burning liquid with water used for cooling purposes.

**Hazardous Combustion Products:** Combustion may yield smoke, carbon monoxide, and other products of incomplete combustion. Oxides of sulfur, nitrogen or phosphorus may also be formed.

See Section 9 for Flammable Properties including Flash Point and Flammable (Explosive) Limits

### 6. Accidental Release Measures

**Personal Precautions:** This material may burn, but will not ignite readily. Keep all sources of ignition away from spill/release. The use of explosion-proof electrical equipment is recommended. Stay upwind and away from spill/release. Notify persons down wind of the spill/release, isolate immediate hazard area and keep unauthorized personnel out. Wear appropriate protective equipment, including respiratory protection, as conditions warrant (see Section 8). See Sections 2 and 7 for additional information on hazards and precautionary measures.

**Environmental Precautions:** Stop spill/release if it can be done safely. Prevent spilled material from entering sewers, storm drains, other unauthorized drainage systems, and natural waterways. Use water sparingly to minimize environmental contamination and reduce disposal requirements. Spills into or upon navigable waters, the contiguous zone, or adjoining shorelines that cause a sheen or discoloration on the surface of the water, may require notification of the National Response Center (phone number 800-424-8802).

**Methods for Containment and Clean-Up:** Notify relevant authorities in accordance with all applicable regulations. Immediate cleanup of any spill is recommended. Dike far ahead of spill for later recovery or disposal. Absorb spill with inert material such as sand or vermiculite, and place in suitable container for disposal.

## 7. Handling and Storage

**Precautions for safe handling:** Wear eye/face protection. Wash thoroughly after handling. Use good personal hygiene practices and wear appropriate personal protective equipment.

High pressure injection of hydrocarbon fuels, hydraulic oils or greases under the skin may have serious consequences even though no symptoms or injury may be apparent. This can happen accidentally when using high pressure equipment such as high pressure grease guns, fuel injection apparatus or from pinhole leaks in tubing of high pressure hydraulic oil equipment.

Do not enter confined spaces such as tanks or pits without following proper entry procedures such as ASTM D-4276 and 29CFR 1910.146. Do not wear contaminated clothing or shoes.

"Empty" containers retain residue and may be dangerous. Do not pressurize, cut, weld, braze, solder, drill, grind, or expose such containers to heat, flame, sparks, or other sources of ignition. They may explode and cause injury or death. "Empty" drums should be completely drained, properly bunged, and promptly shipped to the supplier or a drum reconditioner. All containers should be disposed of in an environmentally safe manner and in accordance with governmental regulations. Before working on or in tanks which contain or have contained this material, refer to OSHA regulations, ANSI Z49.1, and other references pertaining to cleaning, repairing, welding, or other contemplated operations.

**Conditions for safe storage:** Keep container(s) tightly closed. Use and store this material in cool, dry, well-ventilated area away from heat and all sources of ignition. Store only in approved containers. Keep away from any incompatible material (see Section 10). Protect container(s) against physical damage.

## 8. Exposure Controls / Personal Protection

Component	US-ACGIH	OSHA	Other
Lubricant Base Oil (Petroleum)	TWA: 5mg/m <sup>3</sup> STEL: 10 mg/m <sup>3</sup> as Oil Mist, if generated	TWA: 5 mg/m <sup>3</sup> as Oil Mist, if generated	---

**Note:** State, local or other agencies or advisory groups may have established more stringent limits. Consult an industrial hygienist or similar professional, or your local agencies, for further information.

**Engineering controls:** If current ventilation practices are not adequate to maintain airborne concentrations below the established exposure limits, additional engineering controls may be required.

**Eye/Face Protection:** The use of eye protection that meets or exceeds ANSI Z.87.1 is recommended to protect against potential eye contact, irritation, or injury. Depending on conditions of use, a face shield may be necessary.

**Skin/Hand Protection:** The use of gloves impervious to the specific material handled is advised to prevent skin contact. Users should check with manufacturers to confirm the breakthrough performance of their products. Suggested protective materials: Nitrile.

**Respiratory Protection:** Respiratory protection is not normally required under intended conditions of use. Emergencies or conditions that could result in significant airborne exposures may require the use of NIOSH approved respiratory protection. An industrial hygienist or other appropriate health and safety professional should be consulted for specific guidance under these situations.

**Suggestions provided in this section for exposure control and specific types of protective equipment are based on readily available information. Users should consult with the specific manufacturer to confirm the performance of their protective equipment. Specific situations may require consultation with industrial hygiene, safety, or engineering professionals.**

## 9. Physical and Chemical Properties

**Note:** Unless otherwise stated, values are determined at 20°C (68°F) and 760 mm Hg (1 atm). Data represent typical values and are not intended to be specifications.

Appearance:	Green
Physical Form:	Semi-Solid
Odor:	Petroleum
Odor Threshold:	No data
pH:	Not applicable
Vapor Pressure:	<0.1mm Hg
Vapor Density (air=1):	> 5
Boiling Point/Range:	No data
Melting/Freezing Point:	No data
Solubility in Water:	Negligible
Partition Coefficient (n-octanol/water) (Kow):	No data
Bulk Density:	7.5 lbs/gal
Percent Volatile:	Negligible
Evaporation Rate (nBuAc=1):	<1
Flash Point:	450°F / 232°C
Test Method:	Cleveland Open Cup (COC), ASTM D92
LEL (vol % in air):	No data
UEL (vol % in air):	No data
Autoignition Temperature:	No data

## 10. Stability and Reactivity

**Stability:** Stable under normal ambient and anticipated conditions of use.

**Conditions to Avoid:** Extended exposure to high temperatures can cause decomposition.

**Materials to Avoid (Incompatible Materials):** Avoid contact with strong oxidizing agents and strong reducing agents.

**Hazardous Decomposition Products:** Not anticipated under normal conditions of use.

**Hazardous Polymerization:** Not known to occur.

## 11. Toxicological Information

### Chronic Data:

#### Lubricant Base Oil (Petroleum)

**Carcinogenicity:** The petroleum base oils contained in this product have been highly refined by a variety of processes including severe hydrocracking/hydroprocessing to reduce aromatics and improve performance characteristics. All of the oils meet the IP-346 criteria of less than 3 percent PAH's and are not considered carcinogens by NTP, IARC, or OSHA.

### Acute Data:

Component	Oral LD50	Dermal LD50	Inhalation LC50
Lubricant Base Oil (Petroleum)	>5 g/kg	>2 g/kg	No data
Zinc dialkyl dithiophosphate	>2000 mg/kg (rat)	>2000 mg/kg (rat)	No data

## 12. Ecological Information

**Ecotoxicity:** Experimental studies show that acute aquatic toxicity values are in the range 1-100 mg/l. These values are consistent with the predicted aquatic toxicity of these substances based on their hydrocarbon compositions. Should be regarded as capable of causing long term adverse effects in the aquatic environment.

**Mobility:** Volatilization to air is not expected to be a significant fate process due to the low vapor pressure of this material. Components may behave differently in the aquatic environment with soaps dispersing and dissolving to some extent in water while the hydrocarbons will float on the surface due to their low water solubility. The hydrocarbon portion would be expected to show low mobility in soil and water. The major environmental fate would be expected to be biodegradation.

**Persistence and degradability:** The base oil constituents of greases are expected to be inherently, but not readily biodegradable. Some of the thickening agents may be readily biodegradable.

**Bioaccumulation Potential:** Log Kow values measured for the hydrocarbon components of this material range from 4 to over 6, and therefore regarded as having the potential to bioaccumulate. In practice, metabolic processes may reduce bioconcentration.

**13. Disposal Considerations**

The generator of a waste is always responsible for making proper hazardous waste determinations and needs to consider state and local requirements in addition to federal regulations.

This material, if discarded as produced, would not be a federally regulated RCRA "listed" hazardous waste and is not believed to exhibit characteristics of hazardous waste. See Sections 7 and 8 for information on handling, storage and personal protection and Section 9 for physical/chemical properties. It is possible that the material as produced contains constituents which are not required to be listed in the MSDS but could affect the hazardous waste determination. Additionally, use which results in chemical or physical change of this material could subject it to regulation as a hazardous waste.

This material under most intended uses would become "Used Oil" due to contamination by physical or chemical impurities. Whenever possible, Recycle Used Oil in accordance with applicable federal and state or local regulations. Container contents should be completely used and containers should be emptied prior to discard.

**14. Transportation Information**

**U.S. Department of Transportation (DOT)**

Shipping Description: *Not regulated*  
 Note: *If shipped by land in a packaging having a capacity of 3,500 gallons or more, the provisions of 49 CFR, Part 130 apply. (Contains oil)*

**International Maritime Dangerous Goods (IMDG)**

Shipping Description: *Not regulated*  
 Note: *U.S. DOT compliance requirements may apply. See 49 CFR 171.22, 23 & 25.*

**International Civil Aviation Org. / International Air Transport Assoc. (ICAO/IATA)**

UN/ID #: *Not regulated*

	LTD. QTY	Passenger Aircraft	Cargo Aircraft Only
Packaging Instruction #:	---	---	---
Max. Net Qty. Per Package:	---	---	---

**15. Regulatory Information**

**CERCLA/SARA - Section 302 Extremely Hazardous Substances and TPQs (in pounds):**

This material does not contain any chemicals subject to the reporting requirements of SARA 302 and 40 CFR 372.

**CERCLA/SARA - Section 311/312 (Title III Hazard Categories)**

Acute Health: Yes  
 Chronic Health: No  
 Fire Hazard: No  
 Pressure Hazard: No  
 Reactive Hazard: No

**CERCLA/SARA - Section 313 and 40 CFR 372:**

This material contains the following chemicals subject to the reporting requirements of Section 313 of SARA Title III and 40 CFR 372:

Component	Concentration*	de minimis
Zinc compound(s)	<2	1.0%

**EPA (CERCLA) Reportable Quantity (in pounds):**

This material does not contain any chemicals with CERCLA Reportable Quantities. This material contains the following chemicals subject to the reporting requirements of 40 CFR 302.4:



**California Proposition 65:**

Warning: This material may contain detectable quantities of the following chemicals, known to the State of California to cause cancer, birth defects or other reproductive harm, and which may be subject to the requirements of California Proposition 65 (CA Health & Safety Code Section 25249.5):

Component	Type of Toxicity
Silica-Crystalline (Quartz)	Cancer
Naphthalene	Cancer

**Canadian Regulations:**

This product has been classified in accordance with the hazard criteria of the Controlled Products Regulations (CPR) and the MSDS contains all the information required by the Regulations.

WHMIS Hazard Class  
D2B

**National Chemical Inventories:**

All components are either listed on the US TSCA Inventory, or are not regulated under TSCA.  
All components are either on the DSL, or are exempt from DSL listing requirements.

**U.S. Export Control Classification Number:** EAR99

**16. Other Information**

**Date of Issue:** 23-Oct-2008  
**Status:** Final  
**Previous Issue Date:** 06-Apr-2005  
**Revised Sections or Basis for Revision:** Emergency Overview (Section 2)  
Health Hazard (Section 2)  
Composition (Section 3)  
Regulatory information (Section 15)  
**MSDS Number:** 722490

**Guide to Abbreviations:**

ACGIH = American Conference of Governmental Industrial Hygienists; CASRN = Chemical Abstracts Service Registry Number; CEILING = Ceiling Limit (15 minutes); CERCLA = The Comprehensive Environmental Response, Compensation, and Liability Act; EPA = Environmental Protection Agency; IARC = International Agency for Research on Cancer; LEL = Lower Explosive Limit; NE = Not Established; NFPA = National Fire Protection Association; NTP = National Toxicology Program; OSHA = Occupational Safety and Health Administration; PEL = Permissible Exposure Limit (OSHA); SARA = Superfund Amendments and Reauthorization Act; STEL = Short Term Exposure Limit (15 minutes); TLV = Threshold Limit Value (ACGIH); TWA = Time Weighted Average (8 hours); UEL = Upper Explosive Limit; WHMIS = Worker Hazardous Materials Information System (Canada)

**Disclaimer of Expressed and implied Warranties:**

The information presented in this Material Safety Data Sheet is based on data believed to be accurate as of the date this Material Safety Data Sheet was prepared. HOWEVER, NO WARRANTY OF MERCHANTABILITY, FITNESS FOR ANY PARTICULAR PURPOSE, OR ANY OTHER WARRANTY IS EXPRESSED OR IS TO BE IMPLIED REGARDING THE ACCURACY OR COMPLETENESS OF THE INFORMATION PROVIDED ABOVE, THE RESULTS TO BE OBTAINED FROM THE USE OF THIS INFORMATION OR THE PRODUCT, THE SAFETY OF THIS PRODUCT, OR THE HAZARDS RELATED TO ITS USE. No responsibility is assumed for any damage or injury resulting from abnormal use or from any failure to adhere to recommended practices. The information provided above, and the product, are furnished on the condition that the person receiving them shall make their own determination as to the suitability of the product for their particular purpose and on the condition that they assume the risk of their use. In addition, no authorization is given nor implied to practice any patented invention without a license.