

ROTTLER

SG100M HEAVY DUTY CYLINDER HEAD MACHINE

OPERATION AND MAINTENANCE MANUAL



MANUAL SECTIONS

INTRODUCTION

INSTALLATION

SAFETY

CONTROL DEFINITIONS

OPERATING INSTRUCTIONS

MAINTENANCE

TROUBLESHOOTING

MACHINE PARTS

OPTIONS

SDS

ORDERING PROCEDURE

Contact your regional Rottler sales rep for assistance in ordering optional equipment, replacement parts, or tooling.

If you are unable to contact your regional Rottler sales rep, call the factory at 253-872-7050 and ask to speak to the parts sales specialist.

Have the following information handy to expedite the ordering process:

1. Your name, business name, and contact number
2. Customer number
3. If you don't have a customer number, your billing address
4. Shipping address if different from billing address
5. Machine model and serial number
6. Part number and description of what you want to order
7. Preferred method of shipment
8. You may also contact us via e-mail with the above information. Send e-mail requests to:
parts@rottlermfg.com or intlparts@rottlermfg.com

In some cases you may be requested to send a photo of the part you are ordering if it is a replacement part, or doesn't appear in the database.

If you are unsure which part you need to order, contact our service department and ask to speak to one of our service consultants. They will assist you in determining which part you require.

THERE IS A MINIMUM ORDER OF \$25.00

INTRODUCTION

Contents

Introduction.....	1-1
Description.....	1-2
Disclaimer	1-2
Limited Warranty	1-3
Online Documentation Access.....	1-4

Introduction

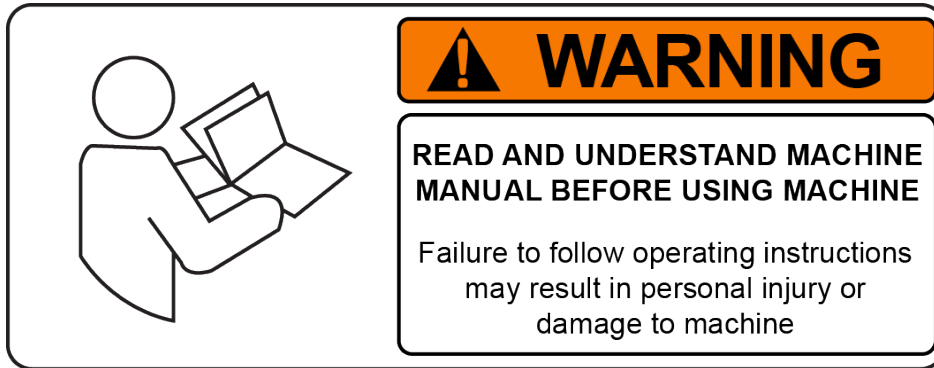

READ THE SAFETY CHAPTER BEFORE INSTALLING MACHINE. THOROUGHLY UNDERSTAND ALL SAFETY ISSUES BEFORE OPERATING MACHINE.

ATTENTION OWNER/BUSINESS MANAGER

To validate the warranty on your new Rottler machine, please be sure to sign and complete the “Installation Report” located in the Installation Chapter of this manual.

We suggest that the new user of the SG100M read the CONTROL DEFINITIONS to get an idea how the machine operates.

The Operating Instructions chapter should be read in order to familiarize the user with the actual button pushing sequences required to carry out a job. These chapters in the manual should be considered an introduction. As the operators of the SG100M series machines gain experience with using the different functions of the machine, complicated setups and programs will make more sense.

The rest of the manual contains information and part number reference on fixtures, cutting tools, and machine maintenance. The operator should read and become familiar with these areas as well.

Description

The Rottler SG80 series were created specifically for machine shops that rebuild small to large cylinder heads found in the heavy duty engine industry. Large cylinder heads come in many shapes and sizes, from 24 valve single casting cylinder heads to huge single cylinder heads used in natural gas, mining and marine workboat engines. We put our trusted engine block machining technology to work designing a heavy duty machine that handles many operations required on a wide variety of cylinder heads.

At Rottler we believed that many large cylinder heads could be “plunge cut” with fixed tooling to save time and money. We realized that plunge cutting would require a very rigid machine utilizing many of our already established design features such as Rottler’s exclusive spindle design.

Over the decades, Rottler’s spindle design has proven that our engine block machines are able to “plunge cut” wide counterbores found in large engine blocks with exceptional results. We used this spindle design for the SG100M and it has since been proven that the SG100M is capable of plunge cutting large valve seats very quickly and with excellent CONCEN and surface finish. The machine has 2 modes of operation:

MANUALMATIC – a brand new concept has been added to these machines which should increase productivity by 30-50%. During seat cutting, the operator does not have to operate any buttons or switches, simply turn the spindle feed steering wheel up and down and the control takes care of all the functions like workhead float/clamp, pilot centering in the valve guide and spindle on/off. When depth of seat is reached, the control automatically changes spindle RPM to high/finish speed to give equal depth of every seat and consistent surface finish results.

MANUAL – the buttons on touch screen are the same as the previous SGM machines. There is no external dial gage, the spindle vertical position is displayed on the touch screen. Simply feed the spindle down until the cutting insert touches the valve seat, touch set zero button and then the digital display will show exactly where the spindle is at all times. The change from low to high/finishing speed is easier as there are 2 separate buttons. The foot pedal for clamp and float of workhead has been eliminated and now controlled on touch screen for manual and automatically for MANUALMATIC.

Disclaimer

The SG100M Manual (henceforth to be referred to as the “Manual”) is proprietary to Rottler Manufacturing LLC. (“Rottler Manufacturing”) and no ownership rights are hereby transferred. No part of the Manual shall be used, reproduced, translated, converted, adapted, stored in a retrieval system, communicated or transmitted by any means, for any commercial purpose, including without limitation, sale, resale, license, rental or lease, without the prior express written consent of Rottler Manufacturing.

Rottler Manufacturing does not make any representations, warranties or guarantees, express or implied, as to the accuracy or completeness of the Manual. Users must be aware that updates and amendments will be made from time to time to the Manual. It is the user’s responsibility to determine whether there have been any such updates or amendments. Neither Rottler Manufacturing nor any of its directors, officers, employees or agents shall not be liable in any manner whatsoever to any person for any loss, damage, injury, liability, cost or expense of any nature, including without limitation incidental, special, direct or consequential damages arising out of or in connection with the use of the Manual.

Rottler Manufacturing and its employees or representatives are not responsible for any information regarding final specifications of any workpiece that is created as a final product when using Rottler equipment. It is the responsibility of the end user of Rottler equipment to determine the final dimensions and finishes of the workpiece that they are working on. Any information regarding final dimensions and finishes that appears in any Rottler literature or that is expressed by anyone representing Rottler is to be regarded as general information to help with the demonstration of or for operator training of Rottler equipment.

Limited Warranty

Rottler Manufacturing Company Model SG100M parts and equipment is warranted as to materials and workmanship. This limited warranty remains in effect for one year from the date of installation or two years from the date of the original shipment from Rottler or whichever date occurs first. This only applies if the machine is owned and operated by the original purchaser and is operated and maintained as per the instructions in the manual. A machine is warranted only if the Installation Report has been properly executed by a certified installation person and received by Rottler at the time of actual installation.

The products are warranted upon delivery to conform to their published specifications and to be free from defects in material and workmanship under normal use for a period of one year from shipment. Should a product not be as warranted, Rottler sole obligation shall be, at its option, to repair, correct or replace the product or to refund the amounts paid for the Product upon its return to a location designated by Rottler. No warranty shall extend to rapid wear Products (including tooling) or to Products which have been subject to misuse (including any use contrary to Rottler instructions), neglect, accident (including during shipment), improper handling or installation, or subject to any modification, repair or service not certified by Rottler. Rottler shall not be liable for any consequential, direct or indirect damages or for any other injury or loss. Buyer waives any right, beyond the foregoing warranty, to make a claim against Rottler. No warranty is provided for any Products not paid in full.

Merchandise cannot be returned to Rottler without prior approval. Customer must contact the Parts Department to get approval and to be issued a Return Goods Authorization number (**RGR#**). Merchandise authorized for return must be returned prepaid. If merchandise is returned with shipping charges collect, the actual amount of these charges may be deducted from any credit which may be due the customer. The **RGR #** assigned by the Parts Department should be written on the shipping label and must appear on a copy of the invoice(s) covering the original shipment. This invoice copy must be included in the box with the parts. Shipment must contain **ONLY** those items on the **RGR** as approved for return. Merchandise must be received within 10 days of the date of **RGR** or the **RGR** will be canceled. All returned merchandise may be subject to a 20% restocking fee on under \$1,000.00 amount or 10% on any items over \$1,000.00. Parts or tooling over 30 days old are considered as customer property and can only be returned with prior approval from Rottler Corporation Management.

The issuance of a **RGR DOES NOT** guarantee credit - it is only authorization for the return of the goods. Credit for return merchandise is at the sole discretion of Rottler. Credit will be issued only after inspection of returned goods.

Tools proven to be defective within the warranty period will be repaired or replaced at the factory's option. We accept no responsibility for defects caused by external damage, wear, abuse, or misuse, nor do we accept any obligation to provide compensation for direct or indirect costs in connection with cases covered by the warranty.

Online Documentation Access

Online documentation for machines and optional equipment can be accessed at the Rottler website. To access documentation open your browser and navigate to <https://www.rottlermfg.com>.

Scroll to the bottom of the page and under the Owner Resources title click the type of documentation you want to access.

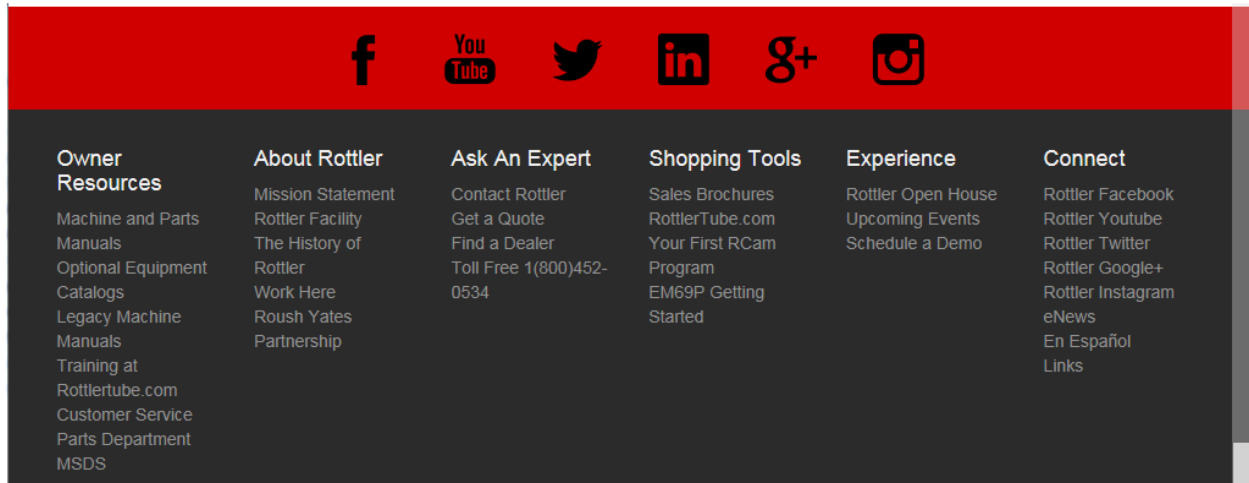

If a log in window pops up asking for user name and password fill in the blanks as shown.

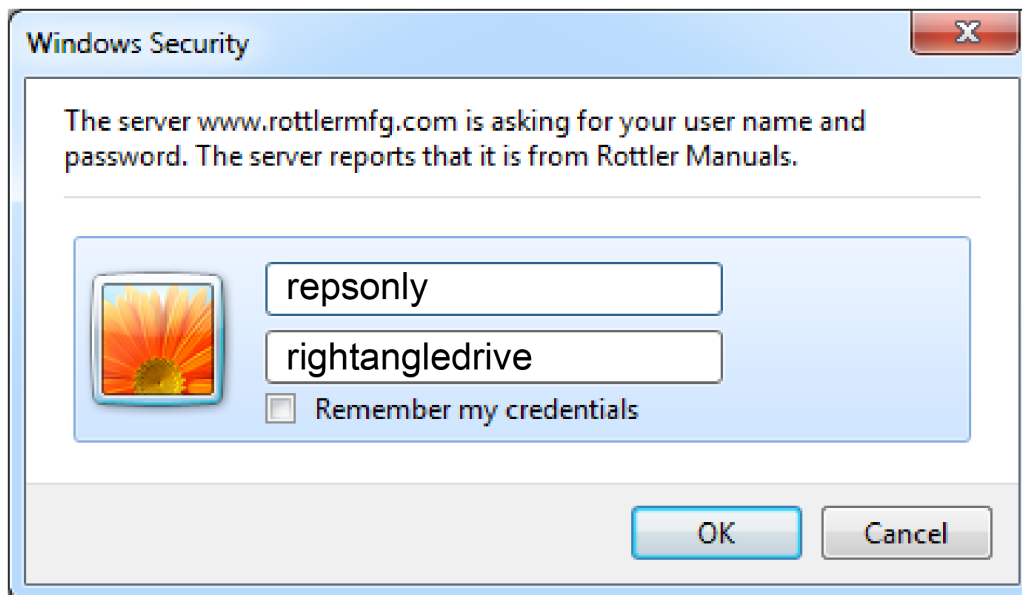

This page intentionally left blank

INSTALLATION

Contents

INSTALLATION REPORT.....2-2

Installation Procedure.....2-6

Location..... 2-6

Unpacking and Lifting..... 2-6

Positioning the Machine 2-6

Removing Shipping Brackets..... 2-7

Leveling the Machine 2-8

Air Supply..... 2-9

Air Adjustments 2-9

Float2-9

Power Supply..... 2-10

Grounding2-11

Transformer Connections.....2-11

ATTENTION OWNER/BUSINESS MANAGER

To validate the warranty on your new Rottler machine, please be sure to sign the installation report after the installation technician has installed the machine and verified the machine is operating correctly and given the operators operation and maintenance training.

Thank you for your cooperation and the opportunity to be of service to you.

ROTTLER MANUFACTURING



OFFICE USE ONLY
Route to: Parts _____ Service Mgr _____ Assembly Mgr _____ Parts _____ Andy _____ Parts _____
Warranty Exp Date _____

ROTTLER MANUFACTURING MUST HAVE THIS REPORT RETURNED TO PROPERLY QUALIFY WARRANTY ON EQUIPMENT

Customer: _____ Address: _____
City: _____ State: _____ Zip: _____ Phone: _____
Country: _____
Machine Model: _____ Serial Number: _____ Representative: _____

MACHINE INSTALLATION: Electrical information MUST be complete to validate this report.

Customer is responsible for providing electricity to machine in a manner that meets the local electrical code requirements.

- _____ Check machine level for equal support on feet.
- _____ This machine requires between 208 and 240 Volts AC, Single Phase, 50/60 Hz power supply. Measure the incoming voltage between L1 and L2. Current requirements for this machine are 30 amps. Measure the incoming AC voltage at least twice during installation.
 - 1) _____ VAC 2) _____ VAC
- _____ Measure each leg of the incoming supply to ground. When using a one leg and neutral of a 380 VAC three phase supply L1 should measure 240 VAC and Neutral should measure almost 0 VAC. L1 to ground _____ VAC L2 to ground _____ VAC.

Make sure all electrical equipment has the proper overload protection. The SG100M should have a stable power supply to prevent damage and uncontrolled movement of the machine.

CAUTION Neutral and machine ground are not the same thing. You should measure an open circuit between Neutral and ground.

CAUTION **IF VOLTAGE IS OUTSIDE THE CORRECT RANGE AT ANY TIME THE MACHINE WILL NOT OPERATE PROPERLY AND MAY BE DAMAGED.**

- _____ Relocate electrical enclosure from shipping location to operating location on lower right side of machine.
- _____ Air of the proper pressure and capacity connected to the machine. Air supply must be free from oil and water. Oil or water will damage electrical and air components. Air pressure should never drop below 90 PSI at any time. Failure to provide adequate air supply may cause improper floating and clamping.
- _____ **BEFORE** turning power on to the machine. Check all wires for security by using the correct screw driver and turning CW until movement stops. Stranded wire can “spread” slightly from vibration during transport.
- _____ Remove all shipping brackets in accordance with the machine manual.
- _____ Clean any rust inhibitor from the machine surfaces. Slide the spindle base from side to side continually cleaning the machine base until all inhibitor is removed.

- _____ Have the operator read through the operation manual before training begins. This will help him be familiar with the button pushing sequences. Have the operator read through the manual again after training and some of the sequences will make more sense.
- _____ Calibrate angle sensor

MACHINE START-UP

-  **CAUTION** When starting the machine for the first time, it may move out of control. Make sure all hands are clear of machine parts. Be ready to press the Emergency Stop button if needed.

- _____ Turn main power on from the main incoming breaker box.

MACHINE MOVEMENTS

- _____ Make sure there is nothing obstructing the full vertical travel of the machine.
- _____ When the machine is on the clamp mode and the air pressure is with the requirements, try to move workhead to verify that you have a solid clamp of Work head.
- _____ Place the level on the leveling post. The level assembly is referenced to the spindle via the level pin. It is therefore important to check alignment of the pin in reference to the spindle. Even though the level has been carefully calibrated at the factory, it is a good idea to recheck calibration before putting the machine into service. In the event that the level is dropped or handled roughly then the following recalibration methods should be implemented. If calibration is required refer to manual for Calibrating the Digital Level
- _____ Start the spindle and verify operation.

INSTRUCTING THE OPERATOR:

Note: Rotter employees and representatives per company policy are not permitted to provide end user of Rottler equipment with any OEM specifications for the workpiece that is created by end user using Rottler equipment.

- _____ Using the operating manual as a guide explain the function of all buttons.
- _____ Cycle all machine movements and supervise the handling of same by operator.
- _____ Demonstrate the engaging of the fine feed system.
- _____ Point out safety features to customer and operator.
- Do not push any buttons without thinking of safety first.

-  **CAUTION** Do not assume the Digital level has been calibrated rotate 180 to verify alignment.

- _____ The following is a checklist to go through every time the machine is started to begin machining a seat.

- Work piece secure
- RPM set
- Tool holder adjusted to the correct setting base on the type of seat you will be machining
- Tool holder locked in place
- Floating of the Workhead and clamping

- _____ Proceed to have operator to machine a seat under you control.
- _____ **Parts ordering, refer to the operating manual for part numbers and description.**
- _____ Review Emergency stop procedure and with operator per operating manual.

Rottler Manufacturing and its employees or representatives are not responsible for any information regarding final specifications of any workpiece that is created as a final product when using Rottler equipment. It is the responsibility of the end user of Rottler equipment to determine the final dimensions and finishes of the workpiece that they are working on. Any information regarding final dimensions and finishes that appears in any Rottler literature or that is expressed by anyone representing Rottler is to be regarded as general information to help with the demonstration of or for operator training of Rottler equipment.

Note: Rotter employees and representatives per company policy are not permitted to provide end user of Rottler equipment with any OEM specifications for the workpiece that is created by end user using Rottler equipment.

General remarks on machine performance, adjustments as received and any further organization or parts required to complete the installation.

Instructions given to: _____

Sales/Service Engineer: _____ Date _____

Shop Foreman/Superintendent or Owner: _____ Date _____

Once completed send this form to:
Rottler Manufacturing
attn: Parts Department
8029 S 200 St
Kent, WA 98032 USA

Alternately you may send this form via fax or e-mail:
fax: [+1] 253-395-0230
e-mail: parts@rottlermfg.com

This page intentionally left blank

Installation Procedure

Location

The productivity of the SG100M will depend a great deal on the proper initial installation. Pay particular attention to the means by which work pieces are lifted into and out of the machine as well as the material handling to and from other operations in your shop. The proper loading arrangements and work location for your SG100M is extremely important.

For shops where large production runs are anticipated, the work pieces should be loaded and unloaded directly from a conveyor. If this is not the case, we suggest you pay considerable attention to the crane so that it covers an adequate area to allow the operator to back up and remove work pieces without creating a cluttered, dangerous work area.

Unpacking and Lifting

Use care when removing the crate materials from the machine. Be careful not to use force on any part of the machine.

Remove the shipping screws (4) from the skid; the shipping brackets will be painted red for easy identification. These screws are located at the four bottom corners of the Main Base.

CAUTION

THIS MACHINE IS TOP-HEAVY. Use care when lifting and moving Machine. Approximate shipping Weight of Machine is 5000 lbs. (2273 kg).

Positioning the Machine



Lift Machine using a fork lift. Move fork lift to front of Machine and separate forks so they are visually centered. Insert forks under front-center of Machine, using care not to damage Foot Pedals Valve or Air Lines. Tilt forks slightly upward so Machine will lean toward fork lift and lift Machine.

While Machine is on fork lift, install five (6) Leveling Screws and Jam Nuts in holes provided in bottom of Machine Base. Two (2) Screws installed in rear-corners and one (2) Screw installed in front and rear -center of Machine Base will serve as Leveling Screws; while two (2) Screws installed in front-corners of Machine Base will serve only as Support Screws.

Move Machine to desired location and placed leveling bolts over the center hole of the Leveling Pad. Be certain to allow sufficient clearance to allow access for leveling and also for connecting air and electrical lines. Lower machine onto leveling pads making certain that the leveling bolts align into counterbore on leveling pads.

Be certain nothing interferes with air or electrical lines running from the floating head assembly to the cabinet. Determine there is no possibility of air or electrical lines dragging on wall surfaces or adjacent machinery.

Wipe top Rails with a clean, dry cloth to remove protective shipping oil.

CAUTION:

Do not attempt to move the Work Head unless Air Supply is connected, and air valve is turned on, and foot Pedal is depressed, allowing Head to float on Rails apply (WD40) or similar degreaser and flow the work Head side by side to remove all the shipping oil from under the work head. (Top Upper surfaces rails should be clean and free of oil).

Removing Shipping Brackets

Before leveling the machine, loosen and remove the all shipping brackets and bolts. (Figures 1 – 5)

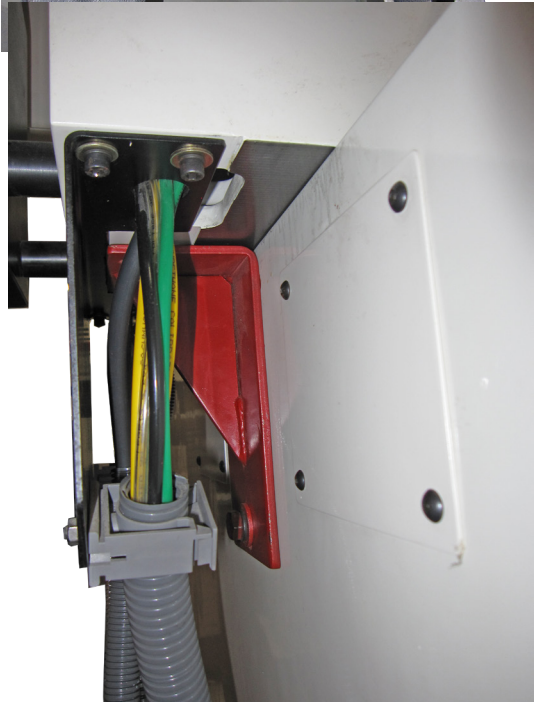
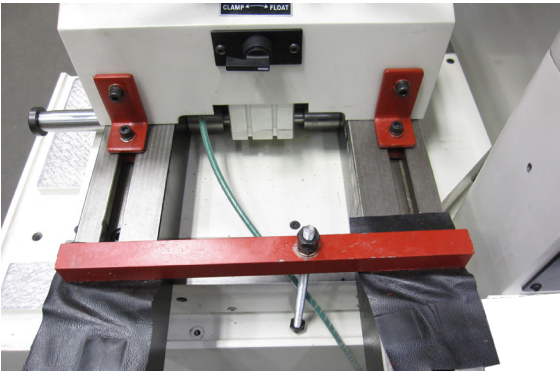

Leveling the Machine

Use required machinist level. (Starret 98 or better).

NOTE: Rotate Level 180° to check that Level is properly adjusted. If Level does not read same in both directions, recalibrate level.



Use the level on the upper float surface, level the machine as precisely as possible, front to back and side to side.

Adjust 4 corners until level and then extend the 2 center leveling bolts to support machine. Tighten jam nuts on leveling bolts and recheck level



Air Supply

It is very important the air source for the SG100M machine be moisture free. Water and oil in the line will result in early cylinder and valve failure. The factory recommends installing a water trap at the machine.

Attach a 100 P.S.I. air source to the appropriate intake pictured, located on the lower left side of the machine.

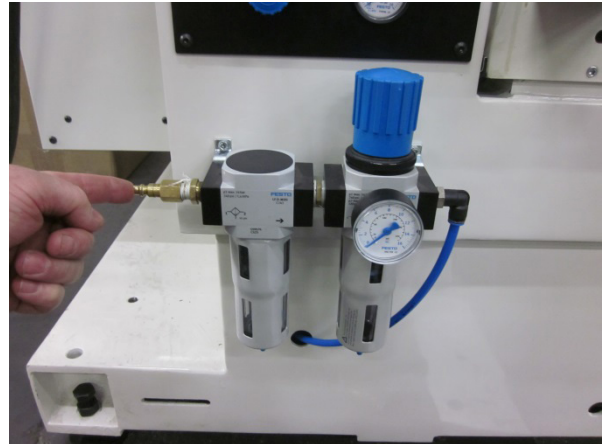

Air Adjustments



Float

The float regulators are located on the left side of machine base. Marked "Work Head Air Float Adjustment" If the work head is not floating properly it could be from too much or too little air from the regulator. Starting with all regulators set at 1 bar with "workhead float" button activated, slowly turn all up .5 bar at a time until workhead start to float. Pushing work head front to rear checking for stiff spots. If workhead is dragging in the forward position, (workhead pulled closest to operator) raise the 2 front regulators 1 mark until it floats without dragging. Same for rear. You may have to go back and forth a few times to get this correct. If workhead is not dragging lower the PSI until it does and then raise 1 notch at a time until it is free. Typically the front two regulators will be slightly higher than the rear two. Once the correct float is established lock the regulators in place by pushing in on the blue adjusting knob.

CAUTION Use as little air as possible to achieve correct floatation. Using too much air will / could cause excessive movement of workhead.

Power Supply

This machine has the following power requirements:

- 208 to 240 VAC
- Single Phase Power
- 50 or 60 Hz
- 30 Amps

See illustration below for correct connection of incoming power. Measured power at the machine's main breaker must be within the required range listed above. If incoming power is not within range, a transformer must be used. Failure to do so will cause the machine to function abnormally and cause permanent damage to the electronic control system.

Some electrical services contain a "Hot Leg, High Leg, or Wild Leg", where single phase is derived from a three phase connection and one leg measures 208VAC to Ground instead of 120VAC. It is not permitted to use the "Hot Leg" for providing power to this machine. Voltage measured between the phases must be between 208VAC and 240VAC, while each phase to ground must be ~120VAC.

IMPORTANT

Electrically connect in accordance with national and local electrical codes.

CAUTION

*Do not attempt to connect more 240VAC to this machine.
Do not attempt to connect to Three Phase Power.*

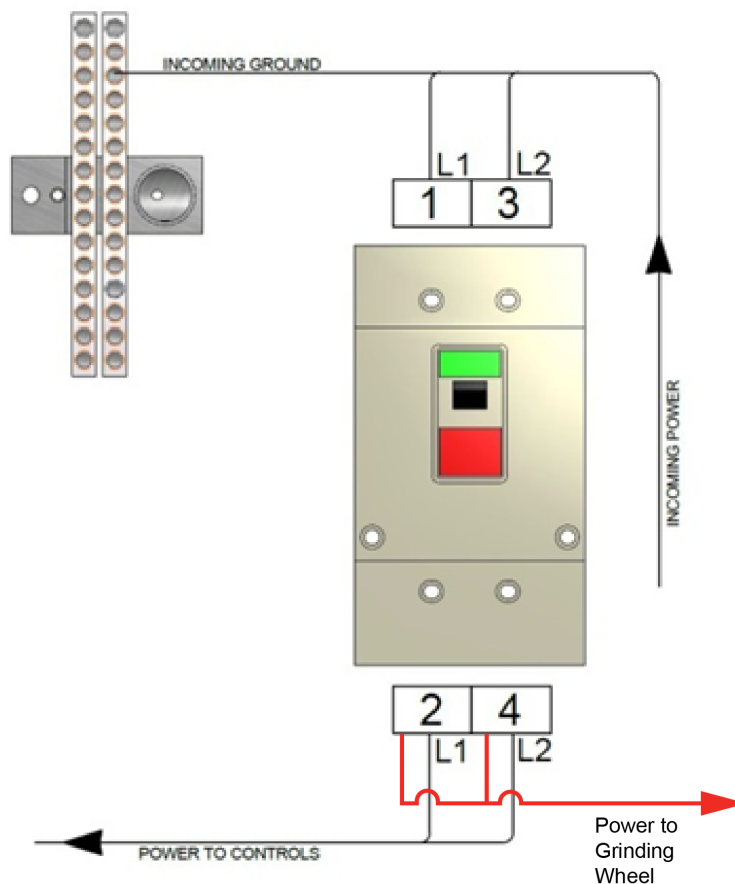

Grounding

The machine requires a good earth ground. The grounding conductor from the incoming power source must be connected to the grounding block located inside of the electrical cabinet. A ground rod installed in addition to the electrical service grounding conductor is permitted, but must be connected directly to the grounding block inside of the electrical cabinet. Connecting the ground rod to the machine base is not permitted. Consult a Licensed Electrician in your area to assess the installation, and install the appropriate ground rod if necessary. Failure to do so may lead to an installation that is unsafe and does not meet national and local electric codes.

Transformer Connections

This machine has the following minimum transformer size requirement:

- 10 kVA

If a transformer is necessary for machine installation, please refer to the diagram below for connection information. Transformers must be sized to meet the minimum power requirements listed above. Consult a Licensed Electrician in your area for transformer selection and installation.

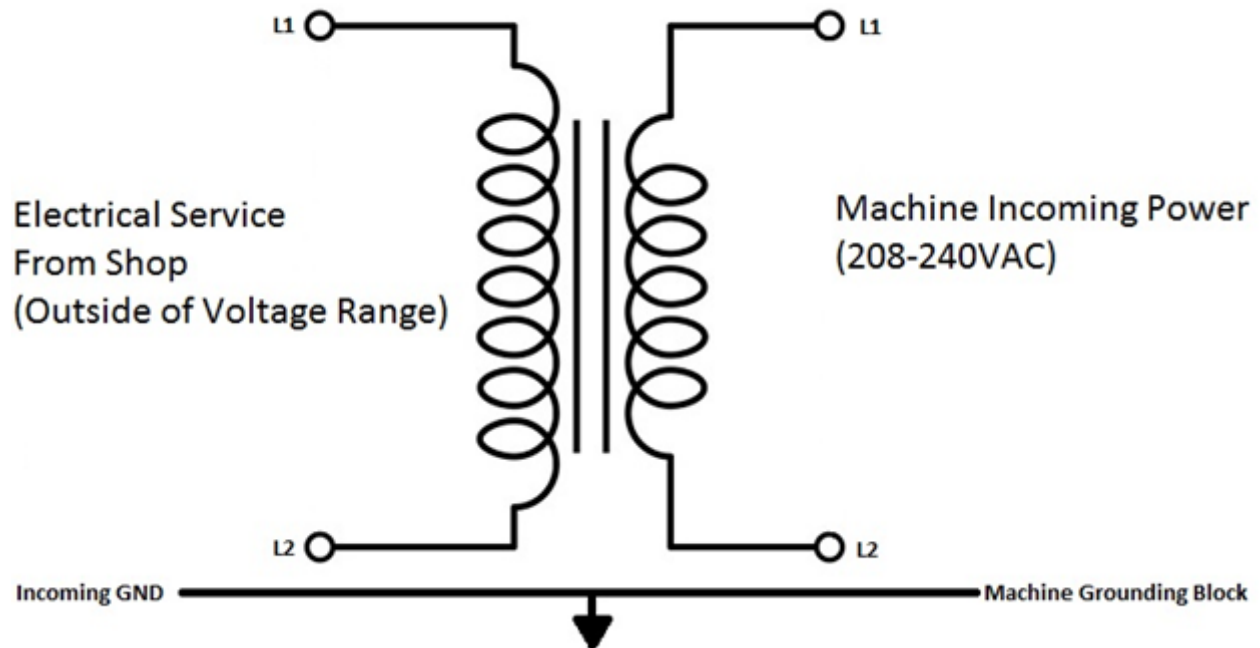

SAFETY

Contents

Safety Information	3-1
Safety Instructions for Machine Use	3-1
Electrical Power	3-3
Machine Operator	3-5
Emergency Procedure	3-6
Computer and Controller System Safety	3-6
Electrical Safety Features Of Rottler DM Controlled Machines	3-7

Safety Information

For Your Own Safety Read This Instruction Manual Before Operating This Machine.

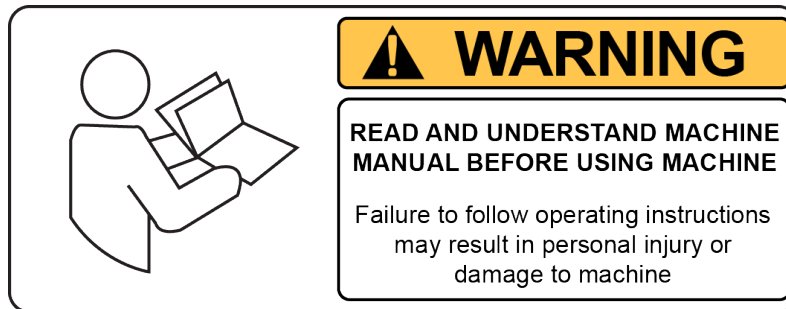

This is the safety alert symbol. It is used to alert you to potential personal injury hazards. Obey all safety messages that follow this symbol to avoid possible injury or death.



DANGER indicates an imminently hazardous situation which, if not avoided, will result in death or serious injury.



WARNING indicates a potentially hazardous situation which, if not avoided, could result in serious injury.



CAUTION indicates a potentially hazardous situation which, if not avoided, may result in minor or moderate injury.



CAUTION used without the safety alert symbol indicates a potentially hazardous situation which, if not avoided, may result in property damage.

Safety Instructions for Machine Use



This machine is capable of causing severe bodily injury

ONLY A QUALIFIED, EXPERIENCED OPERATOR SHOULD OPERATE THIS MACHINE. NEVER ALLOW UNSUPERVISED OR UNTRAINED PERSONNEL TO OPERATE THE MACHINE. Make sure any instructions you give in regards to machine operation are approved, correct, safe, and clearly understood. Untrained personal present a hazard to themselves and the machine. Improper operation will void the warranty.

KEEP GUARDS IN PLACE and in proper working order. If equipped with doors, they must be in the closed position when the machine is in operation.

KEEP WORK AREA CLEAN. Cluttered areas and benches invite accidents.



KEEP CHILDREN AND VISITORS AWAY. All children and visitors should be kept a safe distance from work area.

WEAR THE PROPER APPAREL. **DO NOT** wear loose clothing, gloves, rings, bracelets, or other jewelry which may get caught in moving parts. Non-Slip foot wear is recommended. Wear protective hair covering to contain long hair.



ALWAYS USE SAFETY GLASSES. Also use face or dust mask if cutting operation is dusty. Everyday eye glasses only have impact resistant lenses, they are NOT safety glasses.



DO NOT OVER-REACH. Keep proper footing and balance at all times.

USE THE RECOMMENDED ACCESSORIES. Consult the manual for recommended accessories. The use of improper accessories may cause risk of injury.

CHECK DAMAGED PARTS. Before further use of the machine, a guard or other part that is damaged should be checked to determine that it will operate properly and perform its intended function. Check for alignment of moving parts, breakage of parts, mounting, and other conditions that may affect its operation. A guard or other part that is damaged should be properly repaired or replaced.

NEVER OPERATE A MACHINE WHEN TIRED, OR UNDER THE INFLUENCE OF DRUGS OR ALCOHOL. Full mental alertness is required at all times when running a machine.

IF AT ANY TIME YOU ARE EXPERIENCING DIFFICULTIES performing the intended operation, stop using the machine! Then contact our service department or ask a qualified expert how the operation should be performed.

DO NOT MODIFY OR ALTER THIS EQUIPMENT in any way. If modifications are deemed necessary, all such requests must be approved and/or handled by Rottler Manufacturing. Unauthorized modifications could cause injury and/or damage to machine and will void the warranty.

SAFETY DECALS SHOULD NEVER BE REMOVED. They are there to convey important safety information and warn of potential hazards.

ALL LOCAL SAFETY CODES AND REGULATIONS should be followed when installing this machine.

ONLY QUALIFIED PERSONAL should perform service on the electrical and control systems.

When boring the machine is capable of throwing metal chips over 10- feet from the cutting area. Always use the guards. Eye protection must be worn at all times by the operator and all other personnel in the area of the machine.



CAUTION No list of safety guidelines can be complete. Every piece of shop environment is different. Always consider safety first, as it applies to your individual working conditions. Use this and other machinery with caution and respect. Failure to follow guidelines could result in serious personal injury, damage to equipment or poor work results.

Electrical Power

THIS MACHINE IS AUTOMATICALLY CONTROLLED AND MAY START AT ANYTIME

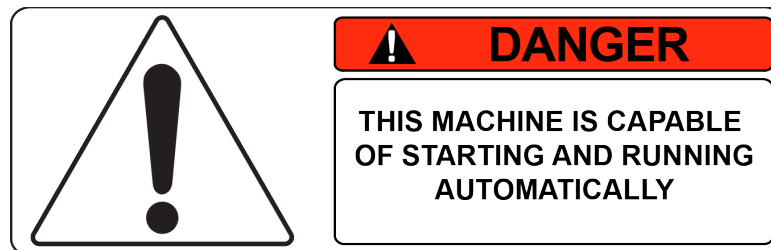

All electrical power should be removed from the machine before opening the rear electrical enclosure..



In the event of an electrical short, grounding reduces the risk of electric shock by providing a path of least resistance to disperse electric current.

Electrocution or a fire can result if the machine is not grounded correctly. Make sure the ground is connected in accordance with this manual. **DO NOT** operate the machine if it is not grounded.

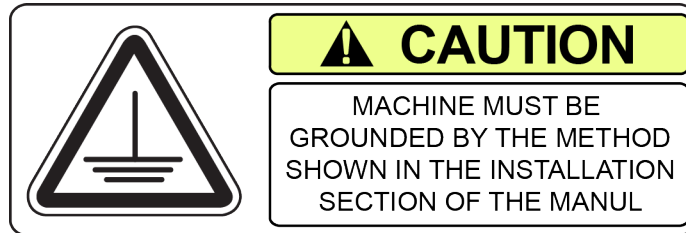

CAUTION No single list of electrical guidelines can be comprehensive for all shop environments. Operating this machinery may require additional electrical upgrades specific to your shop environment. It is your responsibility to make sure your electrical system comply with all local codes and ordinances.

WARNING This machine operates under computerized control and, as is all computerized equipment, and is susceptible to extraneous electrical impulses internally for externally produced. The machine may make moves out of the operator control at any time. The operator should work in and around the machine with caution at all times.

The operator and nearby personnel should be familiar with the location and operation of the Emergency Stop Button.

Make sure all electrical equipment has the proper overload protection. This machine should have **a fully isolated power supply** to prevent damage and uncontrolled movement of the machine. If this machine is on the same power lines that are running to other electrical equipment (grinders, welders, and other AC motors) electrical noise can be induced into this machines electrical system. Electrical noise can cause the controller to see false signals to move. Not supplying a fully isolated supply to the machine may void factory warranty. Refer to the Power supply section located in the Installation section for voltage and amperage requirements of this machine.

Machine Operator

The operator of this machine should be a skilled machinist craftsman who is well versed in the caution, care, and knowledge required to safely operate metal cutting tools.

If the operator is not a skilled machinist he/she must pay strict attention to the Operating Instructions outlined in this manual, and get instruction from a qualified machinist in both production and operation of this machine.

This machine has the following areas of exposed moving parts that you must train yourself to respect and stay away from when they are in motion:

Cutting Tool Area – Any operation involving hands in the cutter head area, such as inspection or alignment of the cutter head or tools, changing Centering Fingers, tool insertion, and removal, cutter head changes, and size checking etc. requires the machine to be in Neutral.

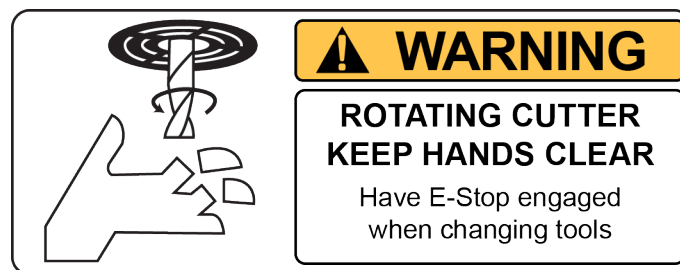

Machining – Eye protection must be worn during all operations of the machine. Hands must be kept completely away from the cutter head. All chip guards must be in position during machine operations.



Work Loading and Unloading – Carefully develop handling methods of loading and unloading work pieces so that no injury can result if hoist equipment or lift connection should fail. Periodically check lift components for damage that may cause failure.



Machine Maintenance – Any machine adjustment, maintenance or parts replacement absolutely requires a complete power disconnection from the machine.

Emergency Procedure

Assuming one of the following has occurred: tool bit set completely off size, work piece or spindle base not clamped, spindle is not properly centered, and these mistakes will become obvious the minute the cut starts

PRESS THE EMERGENCY STOP BUTTON (on the front control panel) **IMMEDIATELY!**

Find out what the problem is; return the spindle to its up position without causing more damage. To restart the machine, turn the Emergency Stop Button CW until the button pops out

Be alert to quickly stop the machine in the event of a serious disruption of the boring process either at the top or bottom of the bores.

“REMEMBER” metal cutting tools have the speed and torque to severely injure any part of the human body exposed to them.

Computer and Controller System Safety

The computer and controller are located in the main rear electrical enclosure. This unit is a full computer, running Windows 7 64 Bit operating system. Contact the factory if more information on the computer system is required.

IMPORTANT The computer in this machine has the ability to connect to the World Wide Web via Ethernet or Wireless using a USB wireless (Wi-Fi) adapter. Updating the Rottler software should **ONLY** be done when directed to do so by a Rottler service technician. Updating Rottler Software when not directed by Rottler personnel will result in a non-operational machine.

The machine should be hooked up to the Internet anytime it is on. The software on the machine will automatically connect to our server to send back useful information on machine status.

Any “IT” personnel should **ALWAYS** get approval from Rottler before doing **ANYTHING** on the computer.

! DANGER This machine is capable of causing severe injury or death. Doing any of the following without Rottler’s direct consent may cause severe injury or death.

! WARNING Do not attempt to install USB devices in the PCI ports. These ports have high voltage and any attempt to connect a USB device in these ports will result in destruction of that device. There is also the possibility of damage to the computer system of the machine.

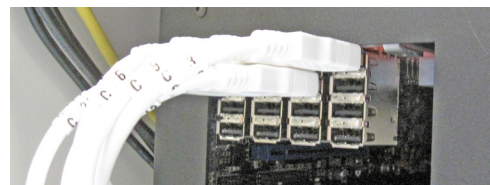

IMPORTANT Downloading any program or changing any Rottler or Computer settings may cause the machine and/or software to become unstable. **DO NOT** install ANY screen saver, Anti-Virus, Spyware or any type of Security software on the computer. This could create a hazardous environment for the operator and personnel around the machine. Performing any of the above will also result in the machine warranty being NULL and VOID.

IMPORTANT **DO NOT** connect any type of external hardware to the computer via USB or any other means. Do not install any type of Device Driver. This could create a hazardous environment for the operator and personnel around the machine. Performing any of the above will also result in the machine warranty being NULL and VOID.

Electrical Safety Features Of Rottler DM Controlled Machines

All Rottler machines that use the DM operational control system are designed to comply with all applicable safety standards. This includes but is not limited to the following systems:

- Thermal sensors in all motors and motor controls.
- Current sensors in all motor control panels.
- Electrical breakers to prevent voltage surges and spikes from reaching electrical system.
- Electrical lockout on main electrical enclosure.
- E-Stop that shuts down all operational systems in an event of an emergency.

All thermal and current limits for motors and motor controls are preset at the factory. In the event that any of those parameters are exceeded during operation of the machine, the machine control system will shut down the machine and a warning of the specific fault will appear on the control screen.

CONTROL DEFINITIONS

Left Side Controls

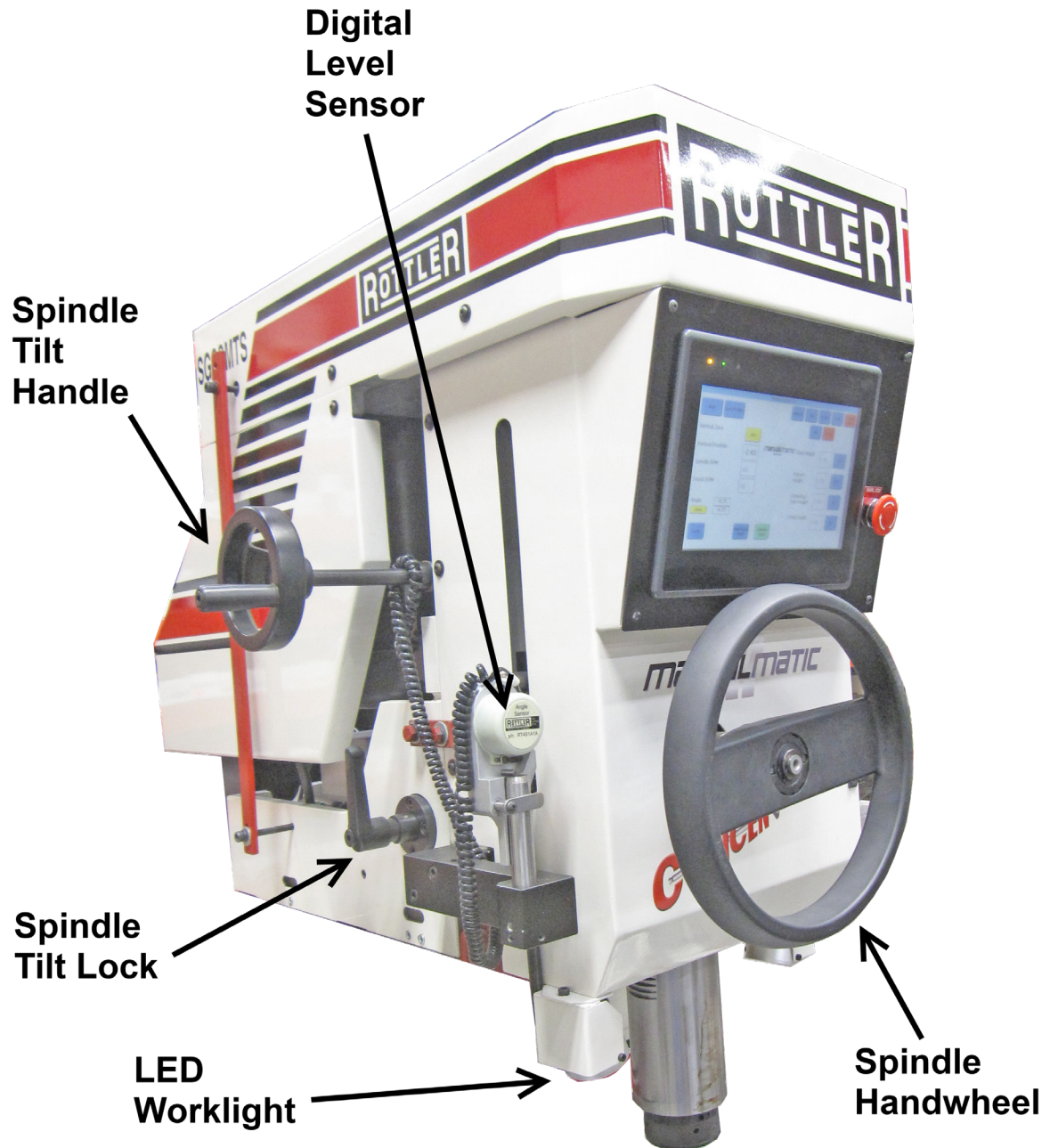

Right Side Controls



OPERATING INSTRUCTIONS

Contents

Operating Instructions	5-1
Mounting Tool Sharpener	5-1
Built In Venturi Vacuum Tester	5-1
Mounting Cylinder Heads	5-2
360 Degree Rollover Fixtures	5-2
Overhead Cam C Clamp System	5-3
Alignment and Setup	5-5
Front to Rear Cylinder Head Alignment	5-5
Left to Right Alignment	5-6
Canted Valve Cylinder heads (Automotive Application)	5-6
Multi Head Fixture	5-7
Fixture Assembly	5-7
Installing Multihead Fixture On Machine	5-9
Installing the Gearbox	5-13
Three Angle Seat Cutting	5-23
Checking Valve Seat Concentricity	5-24
Machining valve seats and Counter Boring	5-25
Aligning Spindle to Work	5-25
Changing the Spindle Adapters	5-25
Installing the Spherical self Aligning Toolholder	5-25
Fine Feed Engagement	5-25
Rottler SG100M MANUALMATIC Touch Screen Control Panel	5-26
Safety Tips Before Machining	5-26
Operation	5-27
Buttons	5-28
MANUALMATIC Operation	5-28

MANUAL	5-29
Buttons	5-29
Operation Tips before Machining Valve Seats	5-29
SEAT MACHINING SUGGESTED RPM CHART	5-30
Valve Seat Machining Procedure	5-30
Changing Language	5-31
UNIPILOT Centralizing Pilots	5-34
Pilot Diameter	5-34
Shank Diameter.....	5-34
Extended Length (EL) Pilots	5-34
Modular Carbide Centralizing Pilot System for Valve Guides Over 0.875” (22.23mm) 5-35	
Unipilot Tooling	5-36
How to Use UPT Series Unipilot Toolholders	5-37
Using the Unipilot System for the UPT5200 / UPT5400 Series Tool Holders	5-39
Rottler Six and One Instructions	5-40
Adjusting the Square Carbide Inserts	5-43
Cutting Small Diameter Valve Seats	5-44
Tooling for Counterboring Small Diameter Valve Seat Pockets	5-45
6 mm Pilots Boring Combos	5-45
.375” Pilot Combos.....	5-45

Operating Instructions

Mounting Tool Sharpener

Mount tool sharpener on right hand side of machine using the cap screw provided with machine.

Sharpening the Rottler form Carbide bits, consists of restoring the tool cutting angle by grinding the face.

To sharpen the carbide bit must be fitted on the bit holder also fitted on the tool holder.

The tool holder will be placed on the adjustable 3/8 fixture of the tool sharpener.

Slide the tool holder on the fixture, and release the adjusting knob.

Adjust the fixture to bring the carbide bit flat against the grinding wheel.

Make sure the carbide tip face is perfectly parallel to the wheel face by pushing it with the thumb. Once a good setting is achieved, lock the adjusting knob.

Before starting the grinding motor, move the carbide bit away from the wheel by rotating the tool holder. The motor should then be started and the carbide tip face moved into the wheel until contact is made.

There is no need to remove a lot of stock from the carbide bit. Sharpening only consists in providing a new cutting face.



Built In Venturi Vacuum Tester

Designed to test valve seat and seat surface seal, and particularly to measure the valve seat surface quality after machining. Including a set of 7 pads and connecting extension.



Mounting Cylinder Heads

360 Degree Rollover Fixtures

Initial clamp height adjustments to the head trunnions can be accomplished by measuring the head thickness then raising the turning clamping block assembly to the appropriate height using the clamping block acme screws. A 10mm T-handle allen wrench works well.

Measure the length of the cylinder head. Spread the trunnion assemblies apart from each other so that the cylinder head can be clamped in between the trunnions.

Each support has an adjustable stop, located to the front. The stops have indents, allowing a number of different settings. Position of the stops must be checked for each cylinder head put on the supports. In most cases we will install the cylinder head deck side down with the exhaust side of the head against the adjustable stops. This is particularly true of wedge style heads. It is necessary for the clamps to thrust the cylinder head against the stops when clamped. When heads are mounted in this fashion, the tallest portion of the combustion chamber will be at the rear of the machine when the head is rotated into the working position. Try to keep the valve guide center line parallel to the trunnion centerline. (Figure 4)

FIGURE 4

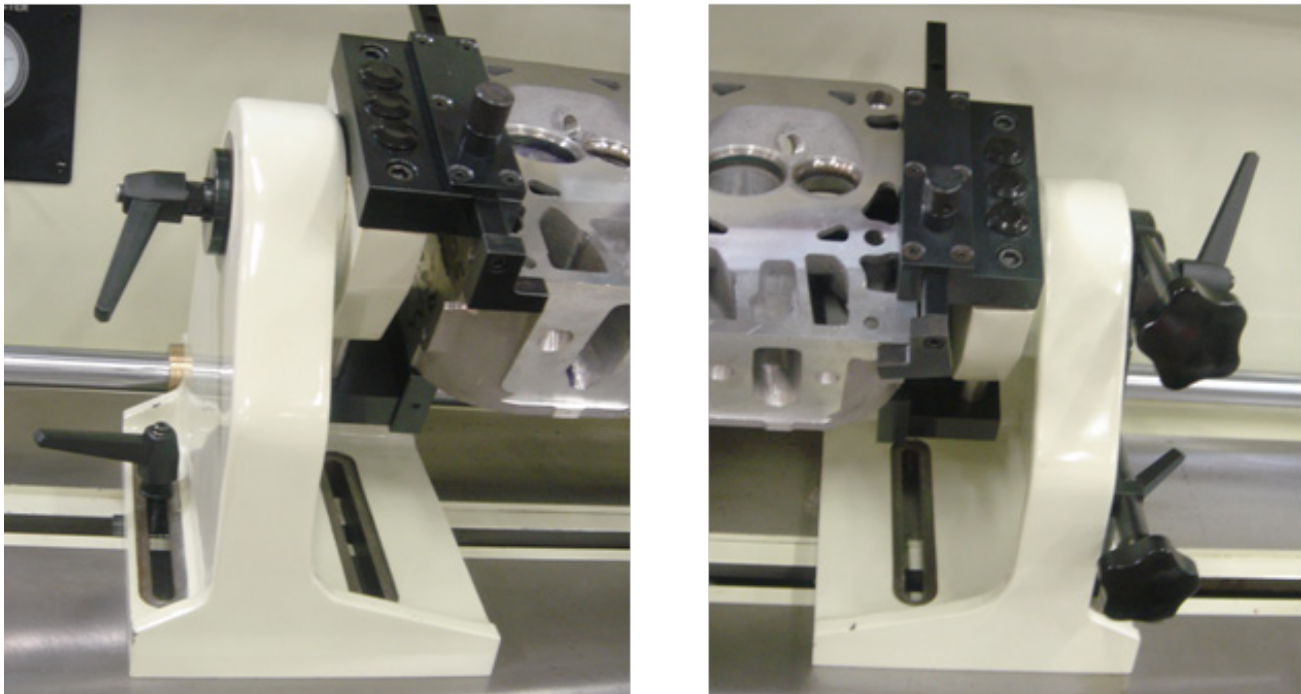

Utilize the grooves in the table to align the trunnion supports square to the machine.

Overhead Cam C Clamp System

Using 10mm Allen wrench, remove the existing lower fixed plate on the 360 degree fixture (left and right)

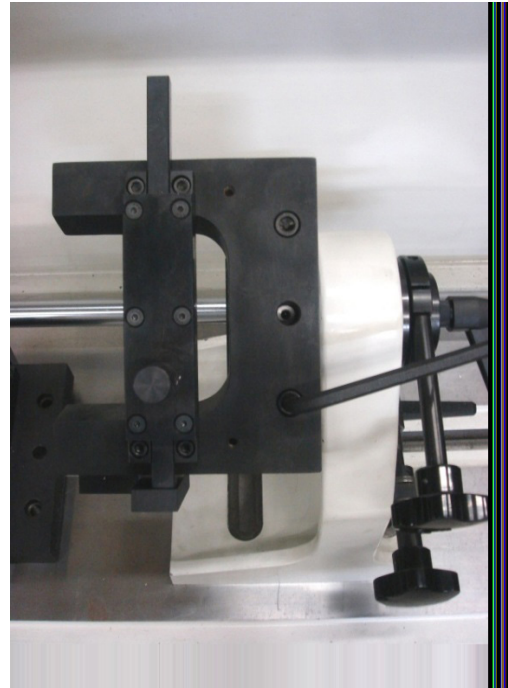
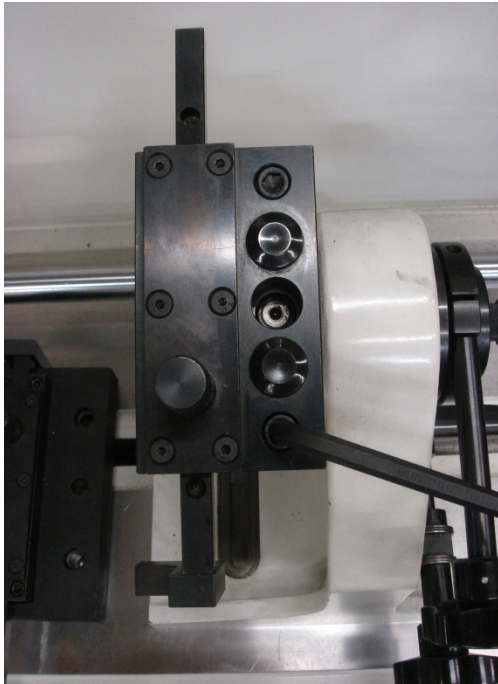

Install the C Clamp, you must use the two bolts included with the fixture and make sure is good and tight

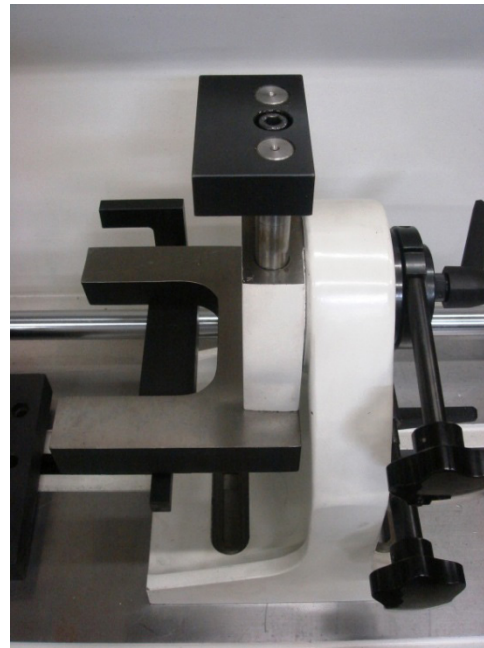
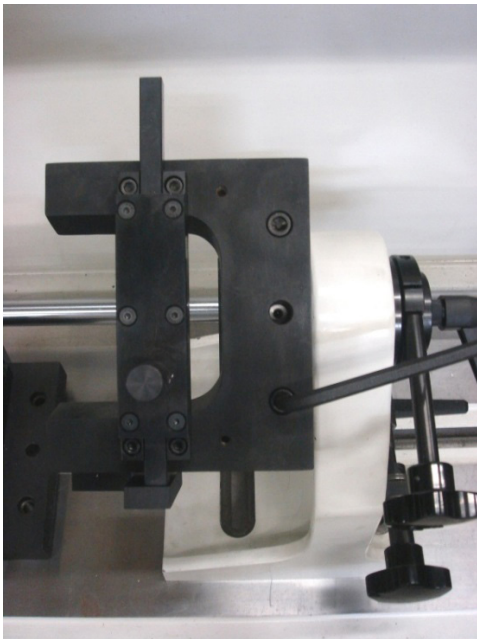

The cylinder head gasket surface must be against the machined surface of the U Clamp Fixture; Slide the stopper rod equally and push the cylinder heads against the stopper rods.

Note: for some cylinder heads, you may need a spacer against between the cylinder head and the stopper rod (not included)

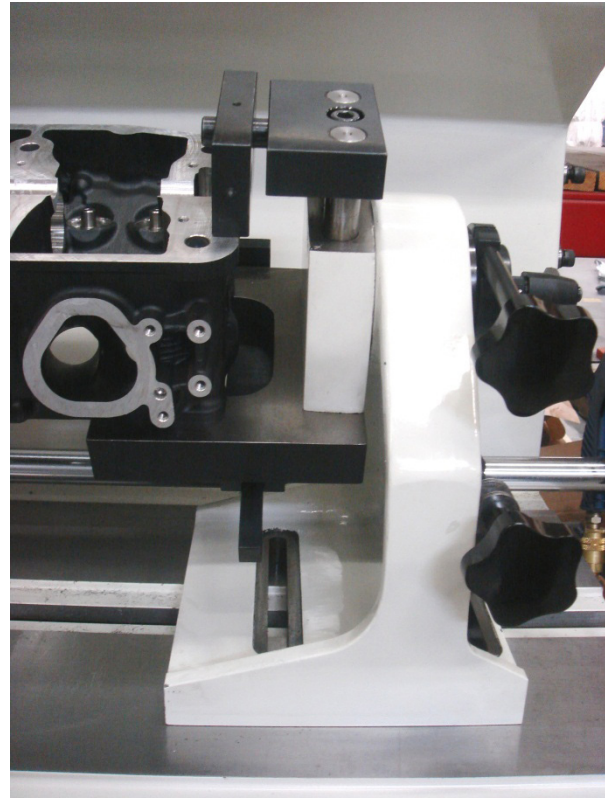
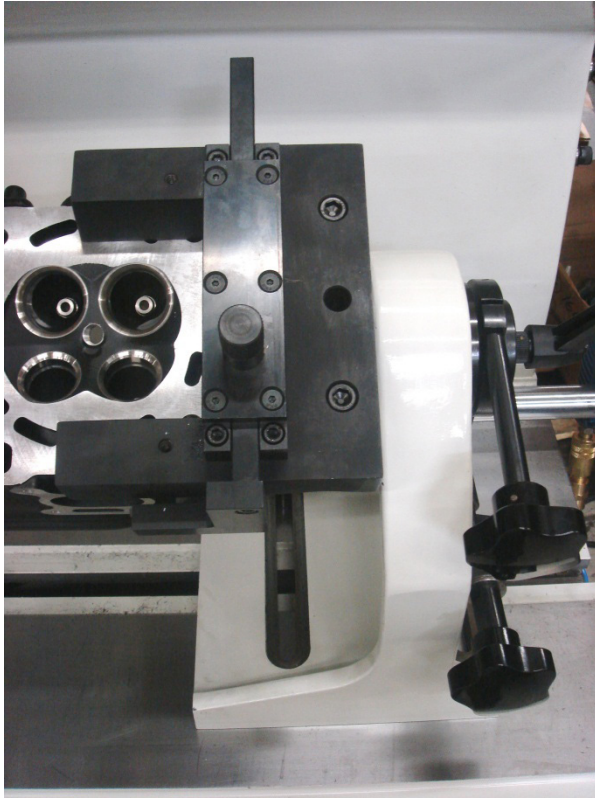

The Quick-Clamp frame is mounted between the trunnions and clamped using the clamping plates. (See Pictures) The cylinder head is then held to the frame with the swivel clamp assemblies through the appropriate head bolt holes or used the standard clamp plates.

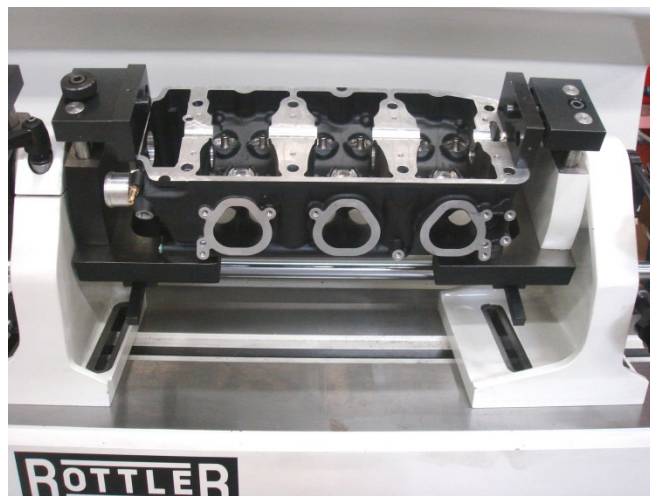

On This cylinder head they using both C frames

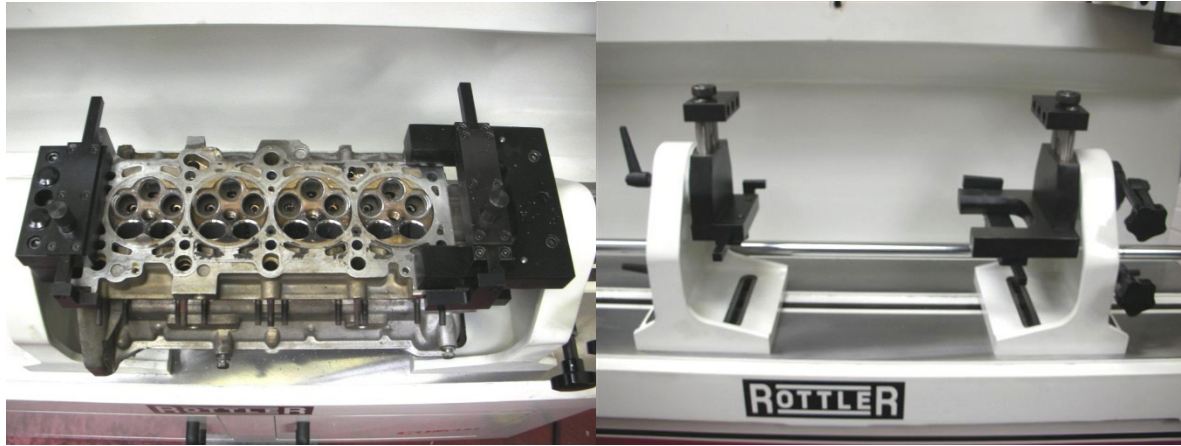

Alignment and Setup

Alignment and setup applies to both the cylinder head and the machine's floating head. The goal is to get perfectly align to the spindle centerline of the area of the head to be machined. Most machining operations on cylinder heads use the valve guide centerline as the reference point so we will use that as an example.

Note: think of the digital electronic level as a comparator. Because the leveling pin is square to the machines spindle, as long as you achieve the same readings front to rear and side to side then the spindle will be in perfect alignment.

Front to Rear Cylinder Head Alignment

Position the level on level pin to read front to rear and take a reading. Rotate the cylinder head so that the valve seats are facing up. Now place the level on a pilot in the cylinder head and position the level to read front to rear. Loosen the lock levers on the supports. Be certain the fine adjustment lock screw is loosened. Coarse adjustment is made by turning the work piece manually, until the level reading is within a couple of degrees of the reading on the leveling post.



Lightly tighten the lock levers on the supports to remove any play. Now tighten the clamp on the fine adjustment screw. Turn the adjustment knob to achieve the exact reading that was observed on the leveling post. You can now completely tighten both the left and right support locks.



Left to Right Alignment

Obtain the left to right reading from a pilot mounted in a guide in the cylinder head. Now place the level on the leveling post. Loosen both of the tilt lock levers on each side of the quill housing. Use the tilt adjusting hand wheel to adjust the reading to be the same as that found on the pilot in the cylinder head. Tighten the tilt lock levers.

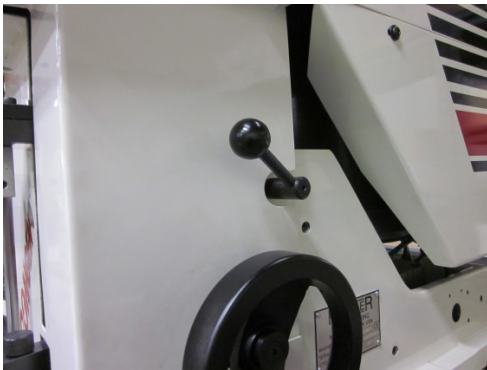

Canted Valve Cylinder heads (Automotive Application)

An optional alignment bar is available that helps establish the front to back alignment on canted valve cylinder heads. The bar is held against two pilots in two adjacent guides. Use the alignment post to adjust the angle. (See Picture)

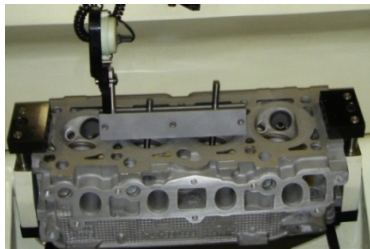

Multi Head Fixture

Fixture Assembly

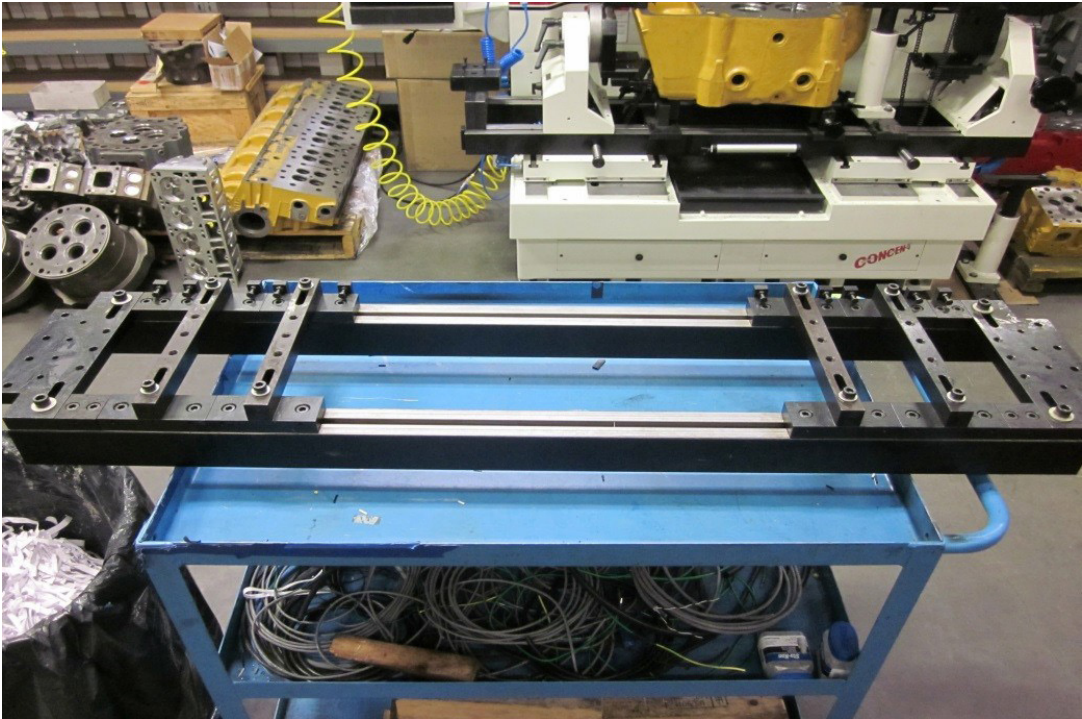

First install clamp bolts with 4 long on the outside. Next install clamp uprights (spacers on these can be removed for different head heights) and finally the clamps.

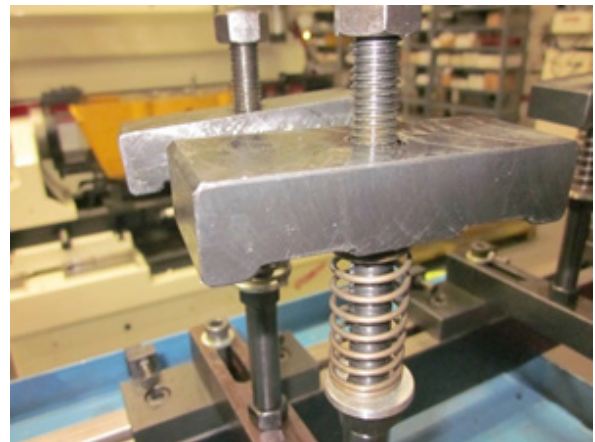

Completed Unit:



Installing Multihead Fixture On Machine

First remove fixed plates from cradle assembly, then clamp plate. To remove clamp plate you must first remove this allen screw.

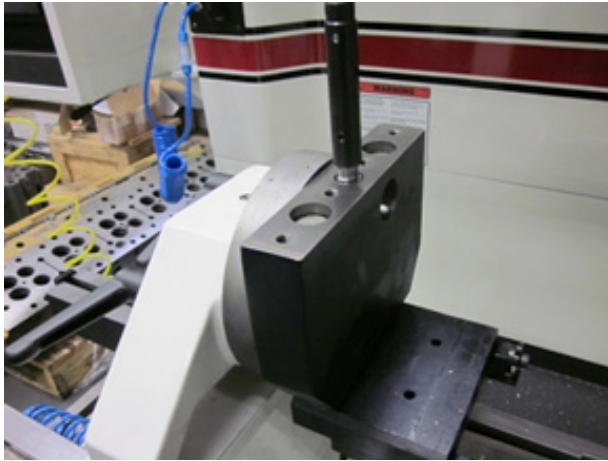

Then lift post off and remove keyway. Roll over and unscrew clamps to remove.

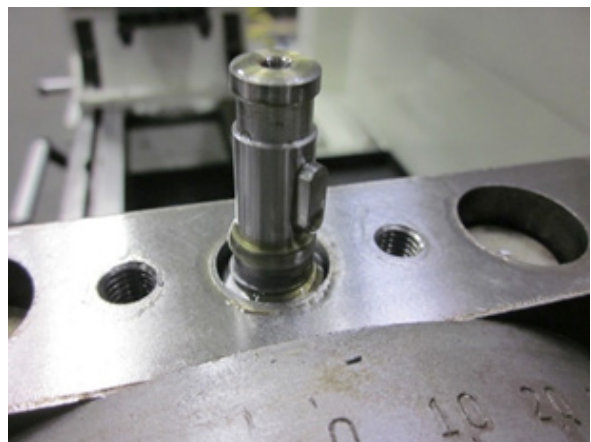

This is what you will have now.

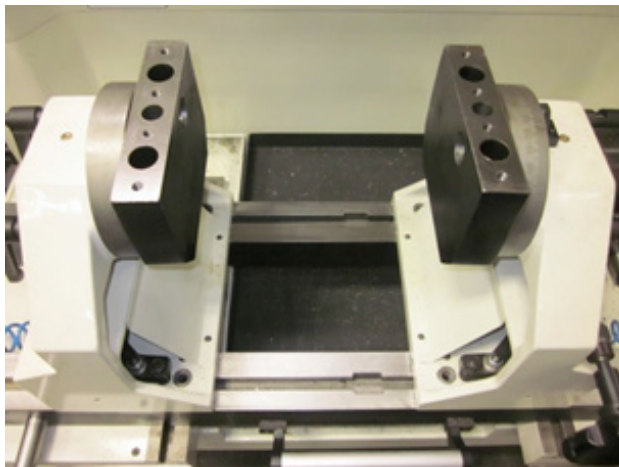

Remove end stoppers as cradles will hang over slightly. Be careful not to slide them off.

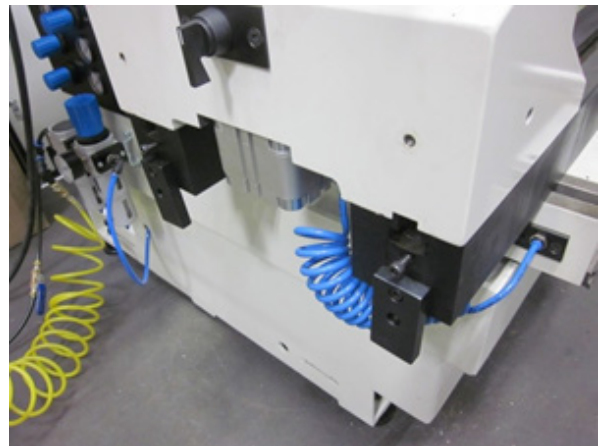
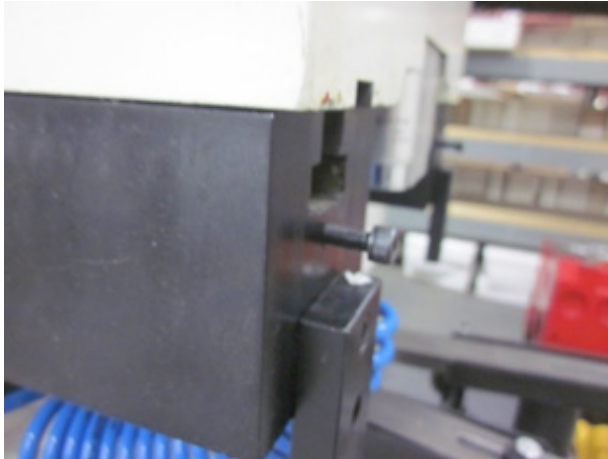

Move cradles to the far ends and lower assembly on and bolt down making sure the stoppers are facing you. Assembly must be flipped over to do this. Roll over for loading position.

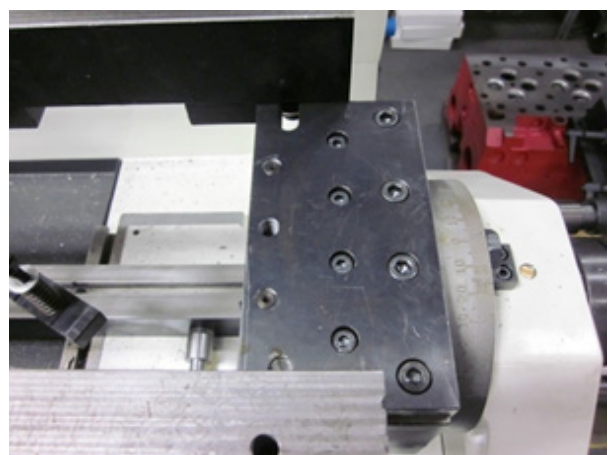
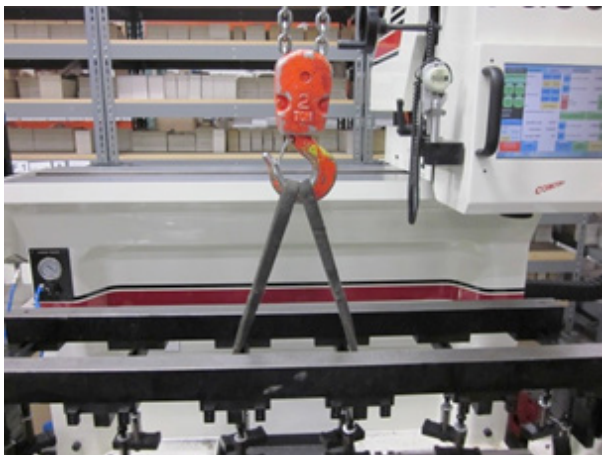

Head Stopper.

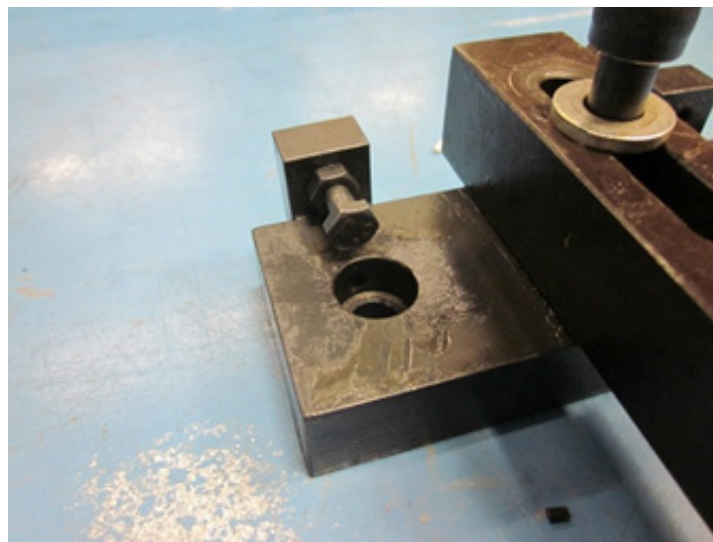

Cutting position



Loading position



You will need to adjust spacing according to the heads you are working on by loosening all 3 allen bolts on each end of clamp screw assemblies. There are end stoppers that can be adjusted also. Stoppers must be away from operator in loading position.



4 Cat 3500 heads in loading position.

4 Cat 3500 heads in cutting position



Installing the Gearbox

Remove 4 bolts from retainer ring

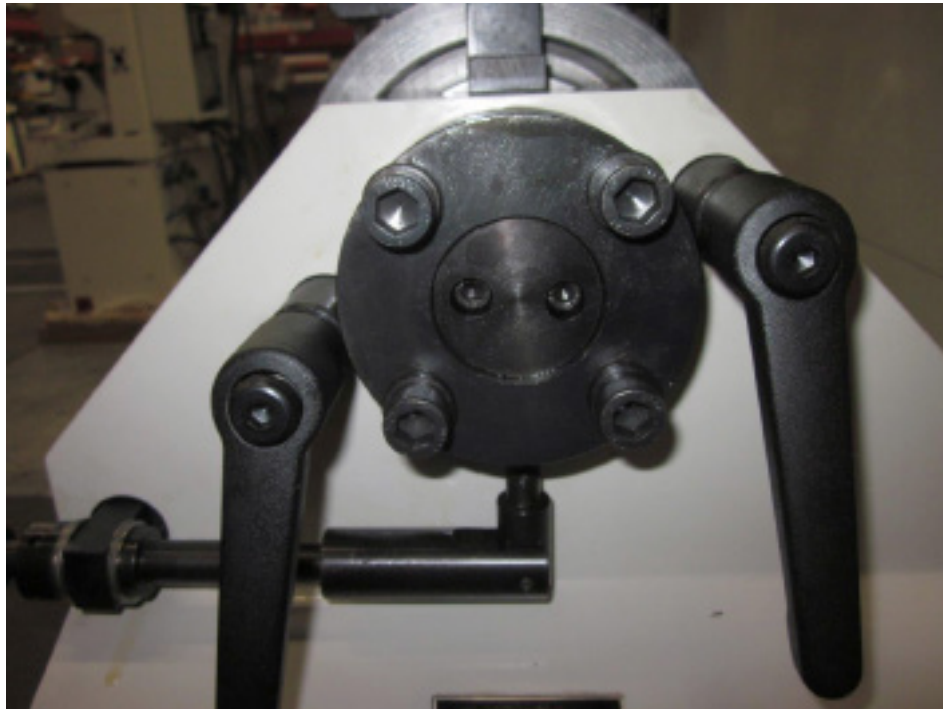

Remove 2 bolts from shaft cap



Remove ring and cap



Disassemble gearbox



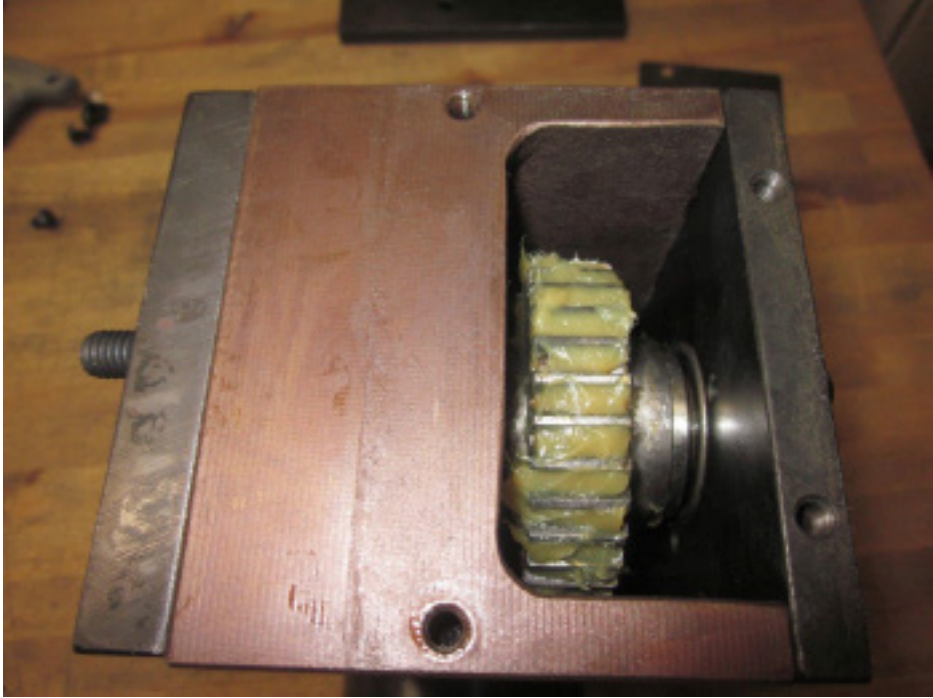

Take mount plate from gearbox and place on fixture

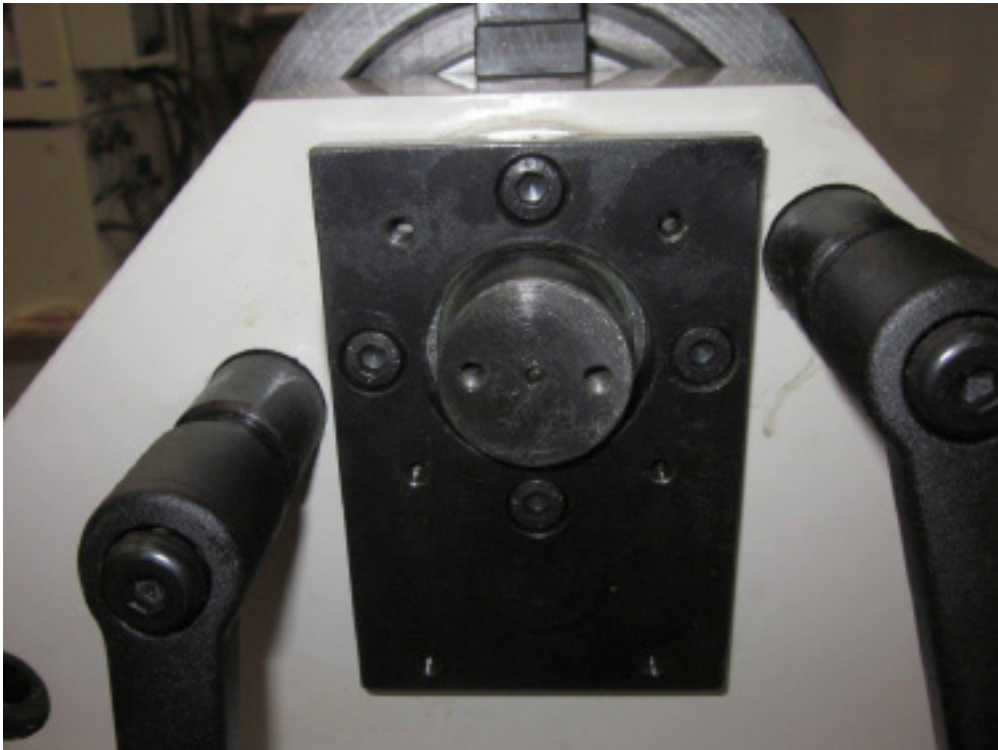

Remove shaft from gear as shown

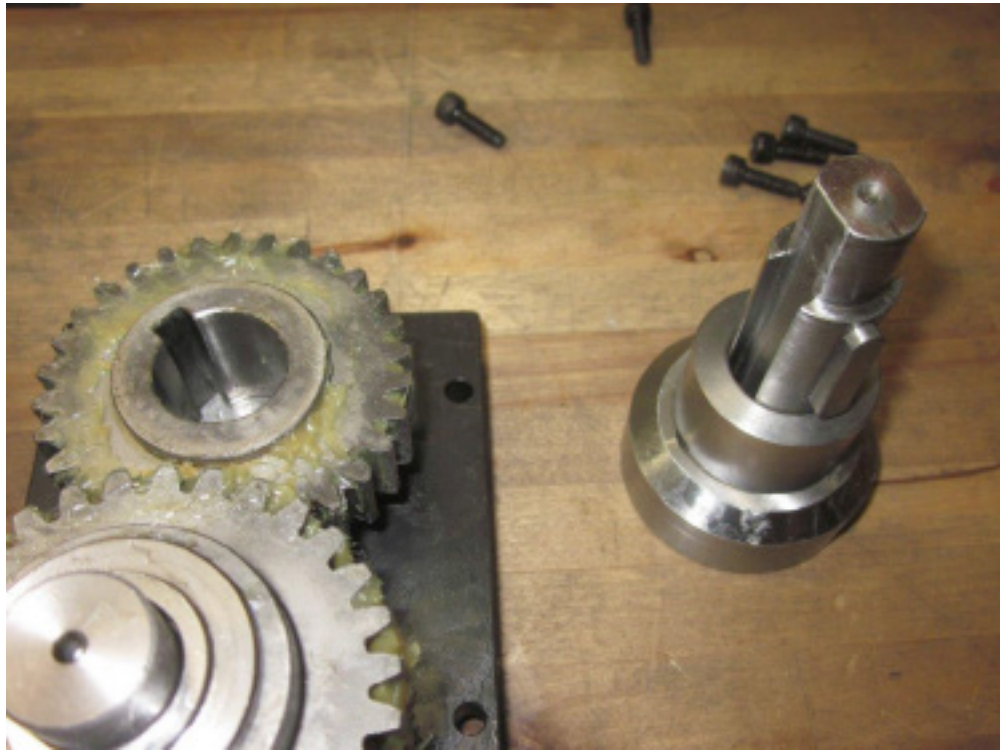

Remove key and spacer from shaft



Bolt gearbox shaft to fixture rotation shaft. Leave bolts loose.



Bolt gearbox housing to mount plate on fixture

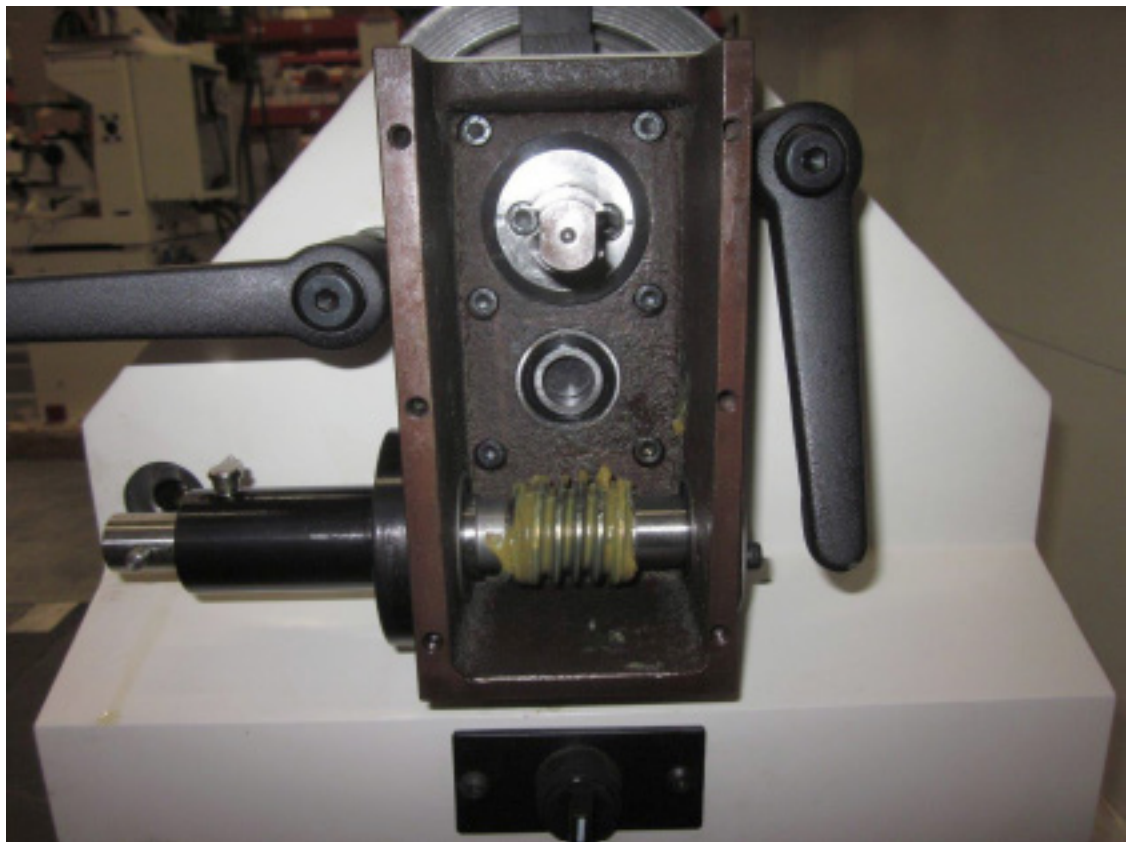

Install gearbox side cover to align shaft

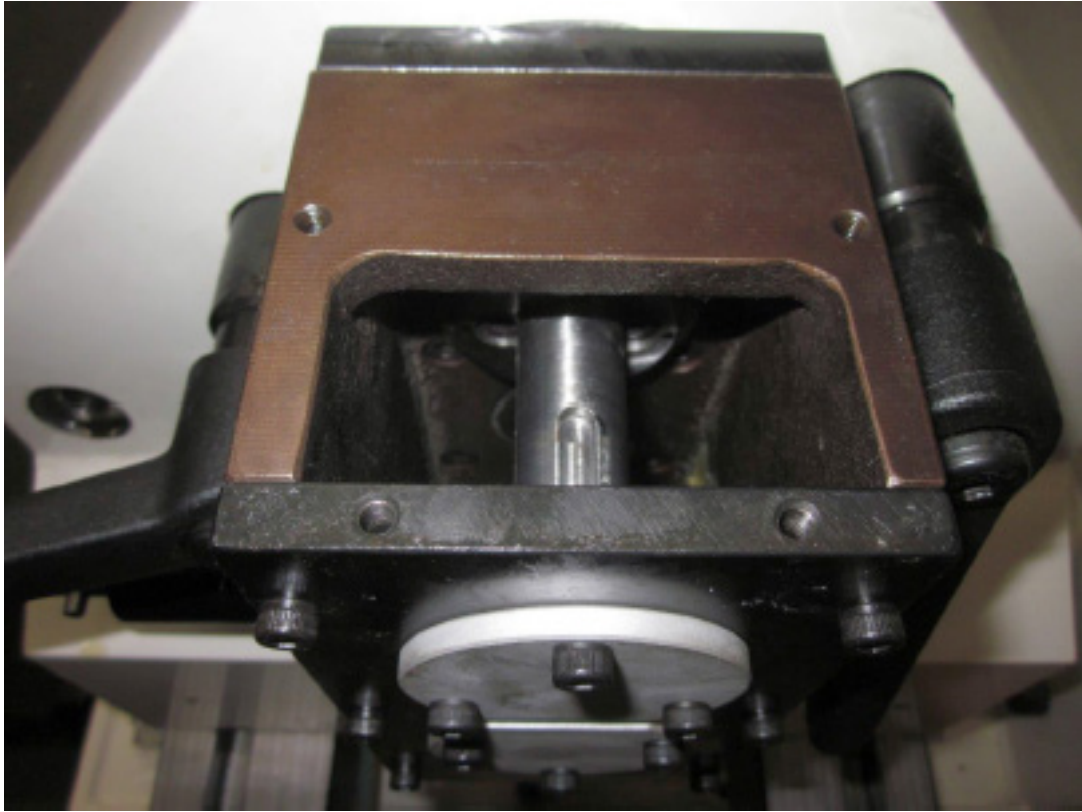

Tighten shaft bolts

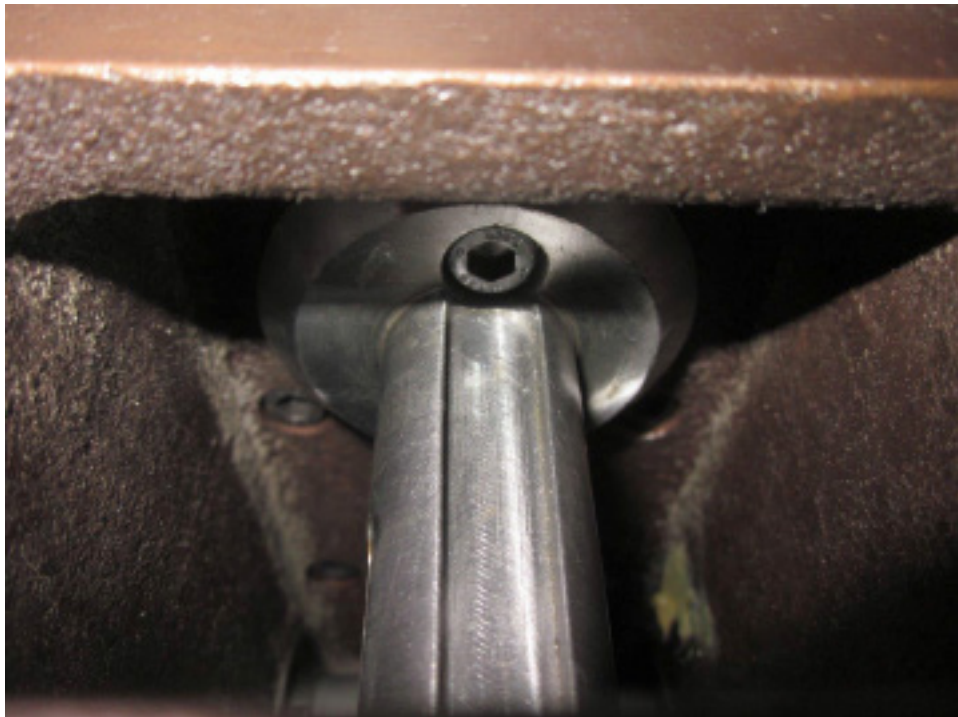

Remove side cover and reinstall spacer and key on shaft. Install gears

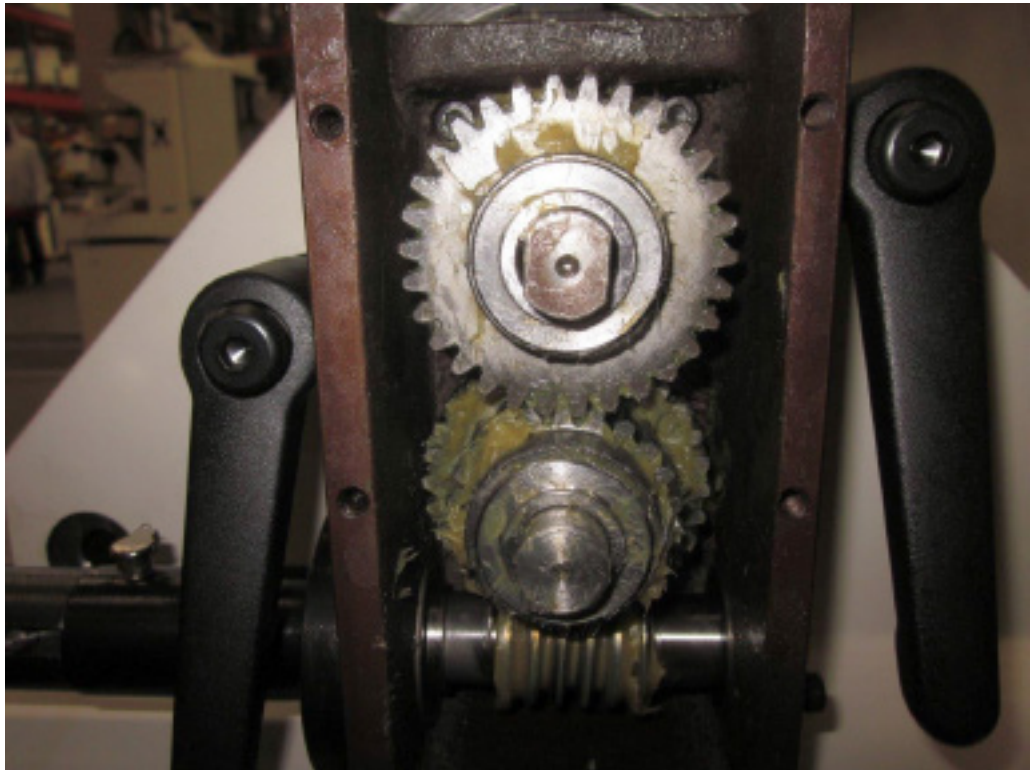

Install side cover



Install top cover

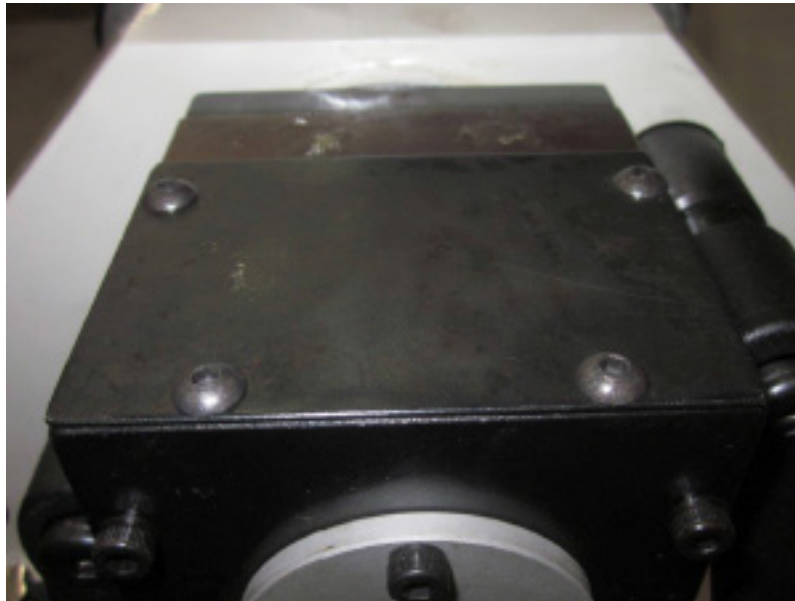

Assemble handle as shown



Install handle on gearbox

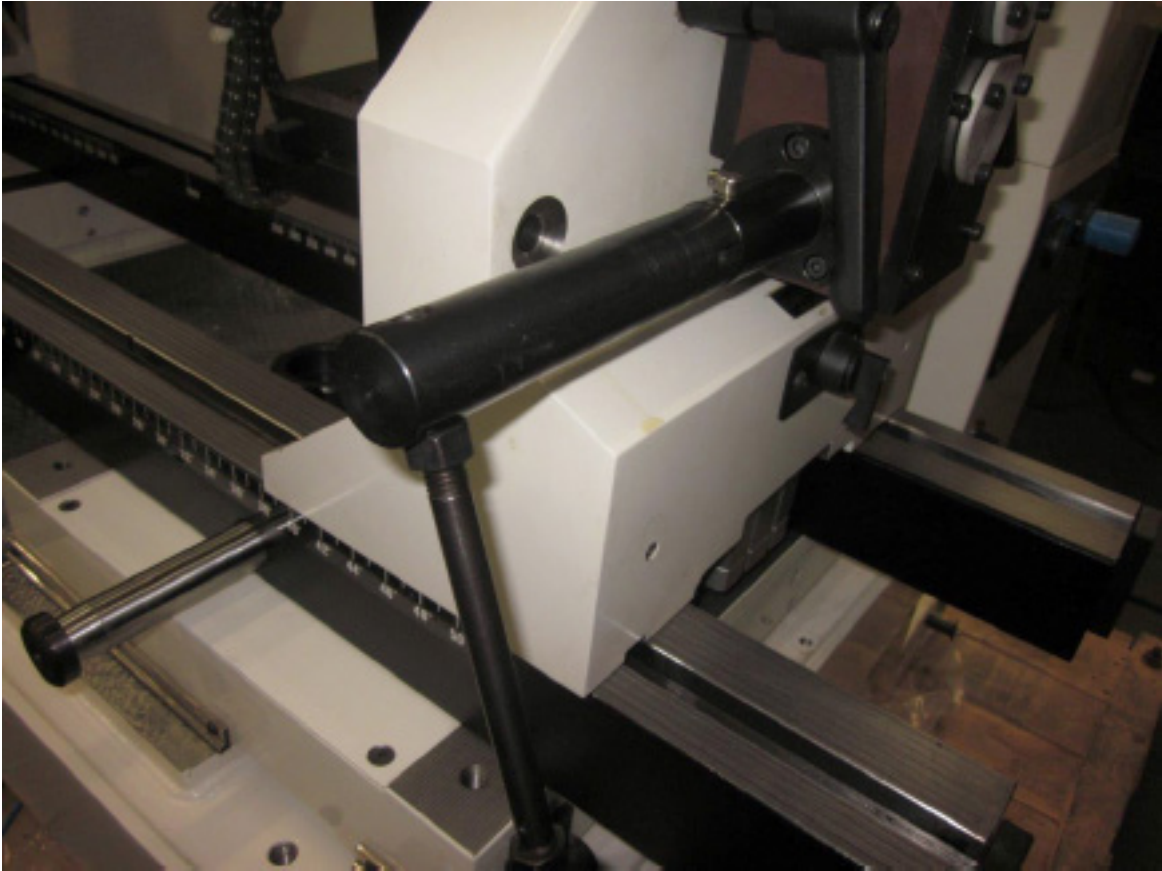

Three Angle Seat Cutting

Place the ball drive adapter in the spindle. Align spindle to valve guide.

Place a valve in the setting fixture. Position the pointer on the valve where you wish to place the top of the seat.

Remove the valve; replace it with the correct pilot.

Select the proper diameter tool holder. Place the carbide insert in tool holder. Slide tool holder onto ball head.

Place ball head over the pilot in setting fixture. Use radial adjusting screw to set diameter of cutter to correspond to position of pointer on setting fixture.

Tighten hex socket screws on bottom of ball head. See figure 9

Remove ball head assembly from setting fixture. Place fixed carbide pilot in cylinder head.

Center the spherical ball head tool holder over the pilot shank.

Required spindle rotation speed will vary, depending on seat hardness. As seat hardness increases, so does the required spindle speed. Some will require full speed.

Special care should be taken in centering the floating head above the valve guide, to achieve a concentric seat.

Cut seat only enough to clean up surface.

Too much cutting will sink the valve too far in the head. Many operators prefer to use the spindle fine feed when machining seats as extreme control of spindle down feed can be accomplished.

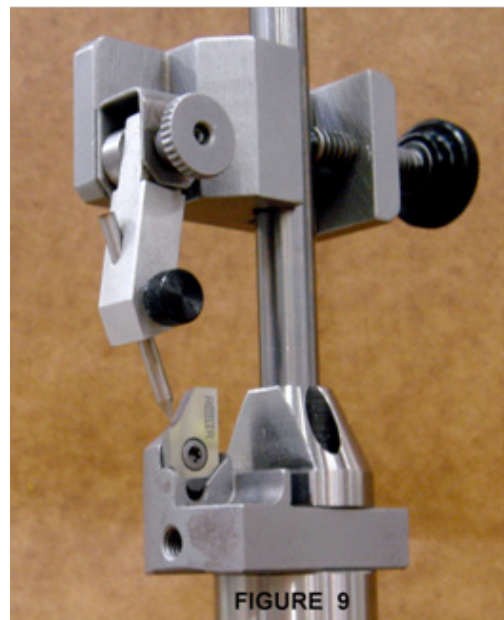
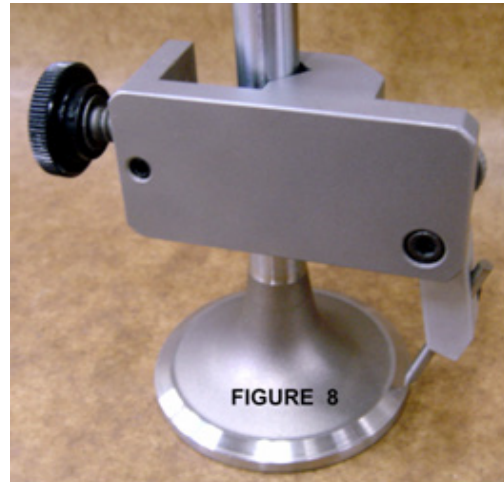

The capacity of the Rottler SG100M associated with a complete tooling range allow working on seats of diameters between 14 and 120 millimeters (0.55"- 4.7").

Three tooling ranges are possible:

- 1) For seats diameters between 14 and 25 mm (0.55"- 1"): tool holder BH600R1 and Mini tip holder TH1999 for seat range .551" - .984" (14mm-25mm) with pilots with 6.00mm shank diameter.
- 2) For seats diameters between 18 and 60 mm (0.71"- 2.4"): tool holder BH375R1, or UPT5100 (SG10A,9M only) and tip holder TH2000 for seat range .710" - 1.180" (18mm-30mm) or TH2001 for seat range 1.100" - 1.570" (28mm-42mm) or TH2002 for seat range 1.570" - 2.360" (40mm-60mm), with 9,52 mm (3/8 ") pilots of shank diameter
- 3) For seats diameters between 40 and 80 mm (1,570"- 3.150"): tool holder BH375WR1 or UPT5300 (SG10A,9M only) and tip holder TH2003 for seat range . 1.570" - 2.360" (40mm - 60mm) or TH2004 for seat range 2.280" - 3.150" (58mm - 80mm), with pilots with 9,52 mm (3/8 ") shank diameter.

IMPORTANT: When the form tips, the square tips or the triangle inserts are fitted, check that their reference faces are perfectly clean.

Checking Valve Seat Concentricity

Make sure pilot and valve seat to be measured are free from dust, burrs, etc. A drop of oil or similar lubricant on valve seat will aid measuring. Loosen brass locking screw and lower dial gauge down over pilot. Make certain the tip of the probe is centered on the valve seat to be inspected.

Grasp brass frame in middle of gauge and move upward approximately 1/8". The dial pointer should move as this is done. Center the pointer of the indicator pointing upward and lock the gauge to the pilot using the brass locking screw. Test proper alignment by moving the brass frame up and down. The pointer should move.

Set the pointer at (0) by turning the dial face.

Inspect the seat run out by rotating the probe around the valve seat by twisting the knurled sleeve with your fingers. Each number on the dial indicator is equal to 0.001", (0.0254mm) run out of the valve seat. Each mark on the dial indicator is equal to 0.0001", (0.00254mm) run out of the valve seat.

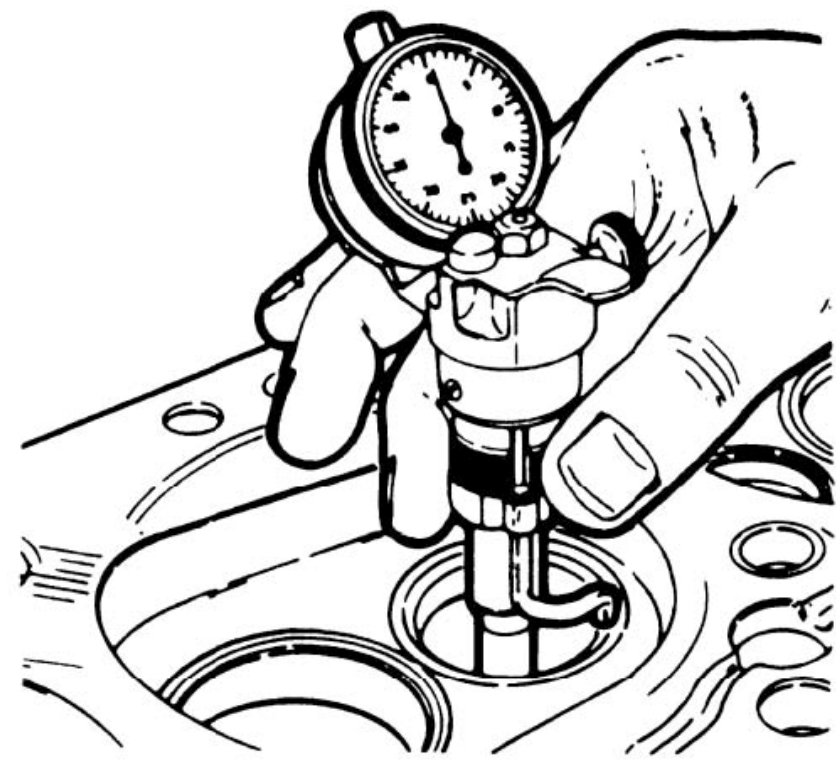

Machining valve seats and Counter Boring

Aligning Spindle to Work

Most machining operations require the spindle to be directly centered over the work to be performed. This is usually accomplished by air floating the work head above the area to be machined then manually lowering the spindle to engage the tooling that's going to be used. Most of the tooling used with the SG9M has been engineered with this centering feature incorporated into the design

CAUTION If the pedal is released too quickly, the floating head may bounce. True centering may not be achieved, if this happens. Slowly releasing the air float pedal gives the best results. Removing your hands completely from the work head during the final seconds of centering will insure that you do not negatively influence centering accuracy.

Changing the Spindle Adapters

Once that you have the tool holder setup, fit the ball head tool holder into the spring free spindle adapter. The SG9MTS spindle has been engineered to allow ultra-fast tooling changes.

Make sure the spindle spring free locking nut is in the off lock position, line up the two ears of the spindle adapter and insert into the spindle ISO 30 taper. The locking nut automatically will be on the lock position, to remove turn the self-locking nut to the left position, hold the spindle adapter, it may drop on the machine table. Damage will result.

Installing the Spherical self Aligning Toolholder

Once the spring free adapter is in the spindle, fit the Rottler Spherical Self aligning Tool holder assembly into the spindle adapter. Make sure to align the locator pins before you fit it into the spindle adapter and push it until you feel it lock.

Fine Feed Engagement

To engage the fine feed mechanism it is necessary to push inward on the steering handwheel while rotating the fine feed handwheel until engagement is achieved. To disengage the fine feed simply pull outward on the steering handwheel

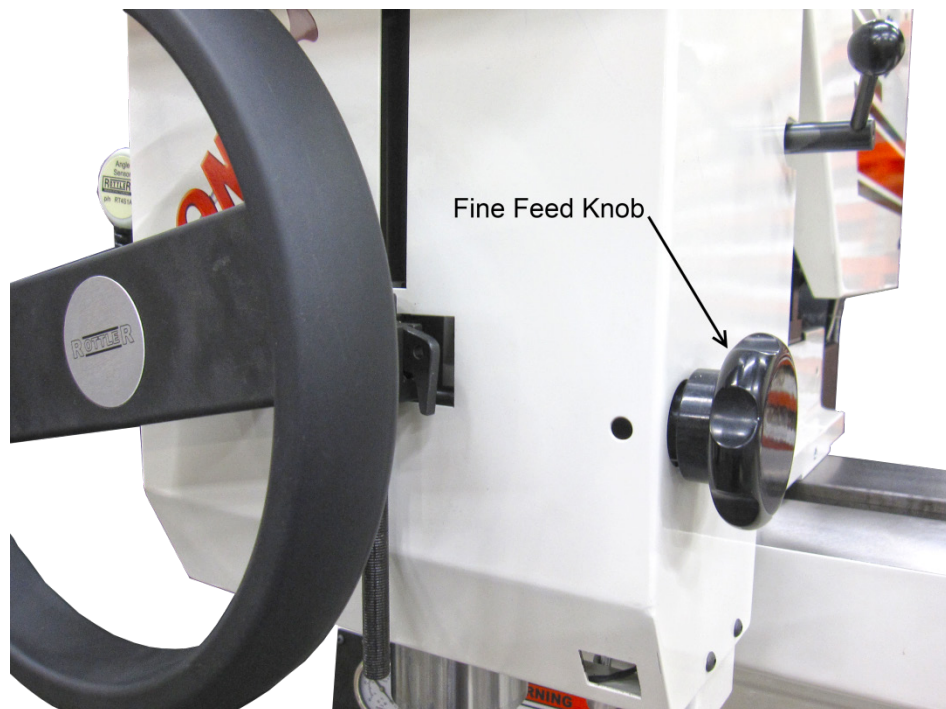

Rottler SG100M MANUALMATIC Touch Screen Control Panel

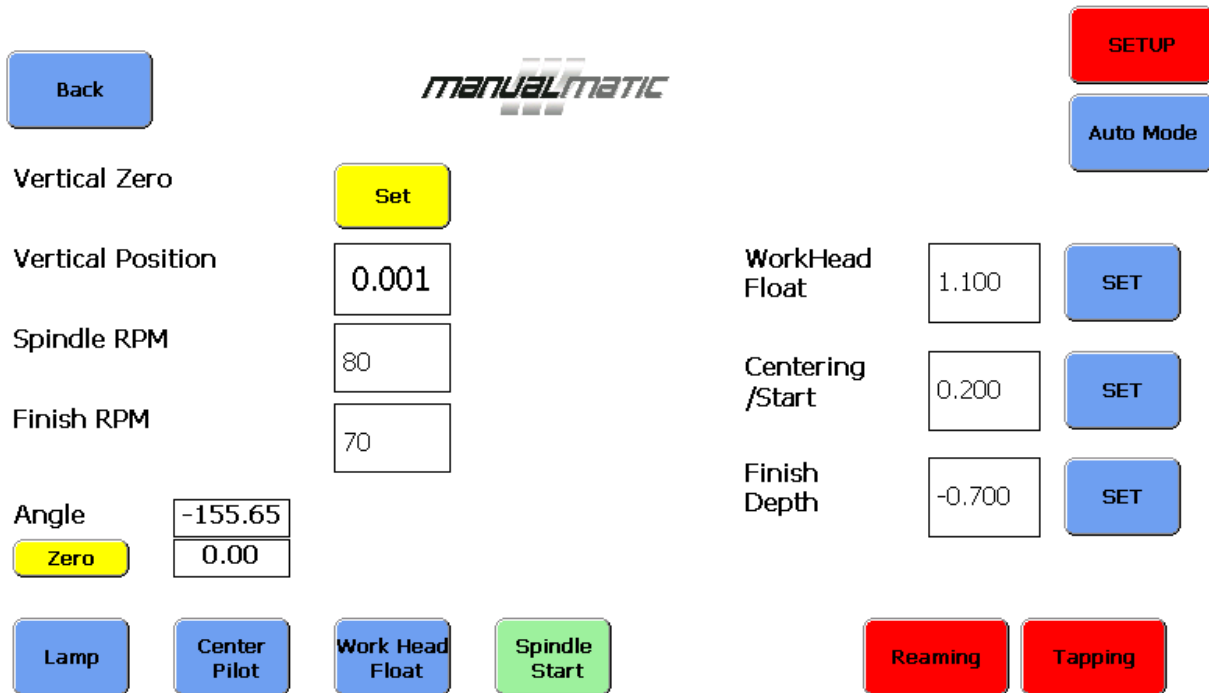

Safety Tips Before Machining

- Always wear proper Safety Items (such as safety glasses and other personal safety equipment as necessary or required).
- Never wear loose fitting clothes or jewelry while working on or around Machine.
- Use proper lifting procedures when moving Cylinder Head.
- Use care when installing and/or removing Cylinder Head from Machine. Lock Head Support Assembly before loading or unloading Cylinder Head.
- Keep area around Machine free of paper, oil, water and other debris at all times.
- Keep Machine and area cleaned of excessive lubricant and lubricant spills.
- Keep Machine clear of tools and other foreign objects not needed for the operation.
- Maintain all tools clean and in their proper storage compartments to maintain them in proper working condition and to prolong tool life.
- Before machining always Inspect tooling for cracks, burrs or bent parts that might affect operation. Inspect Carbide Inserts (Seat Pocket Cutter) and Carbide Cutters (Seat Angle Cutter) to ensure they are sharp, firmly attached and are not damaged.
- NEVER force tools when operating. Tools will do a better and safer job when operated at speed rate for which they were designed.
- Always turn OFF electrical power when performing service on your machine, if service does not require power.
- High Voltage exists inside Electrical Control Enclosure – use caution when working on or around Enclosure. Machine must be disconnected from main power supply before any work can be performed inside of Enclosure.
- Machine must ONLY be operated with all Safety Guards in place and locked.

Operation

Make sure E Stop is in.

Flip switch on Electrical enclosure to ON (up) position, wait for screen to boot up, this may take a few seconds. This is the screen that will appear

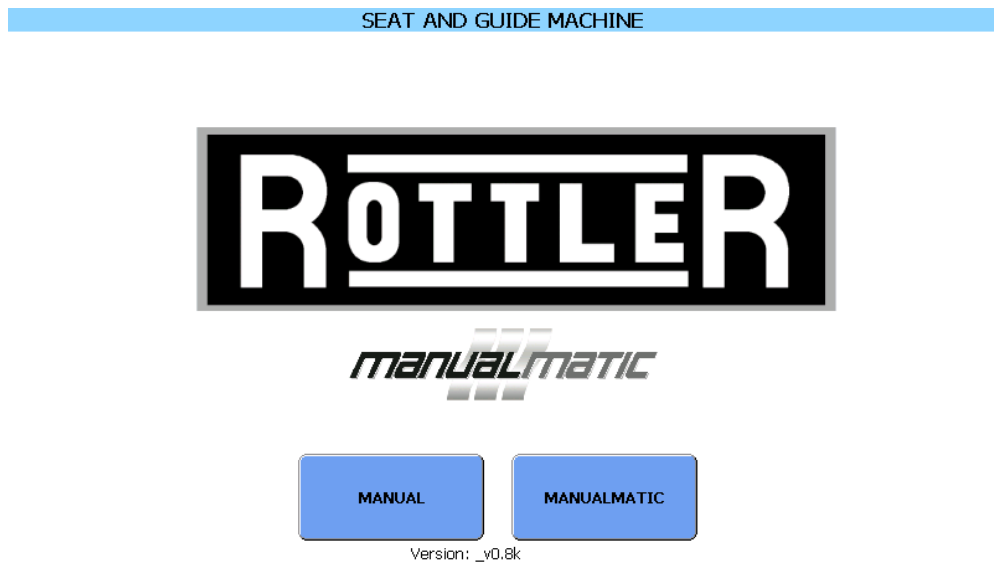

Tap MANUALMATIC for auto mode. Tap MANUAL for manual mode.

MANUALMATIC

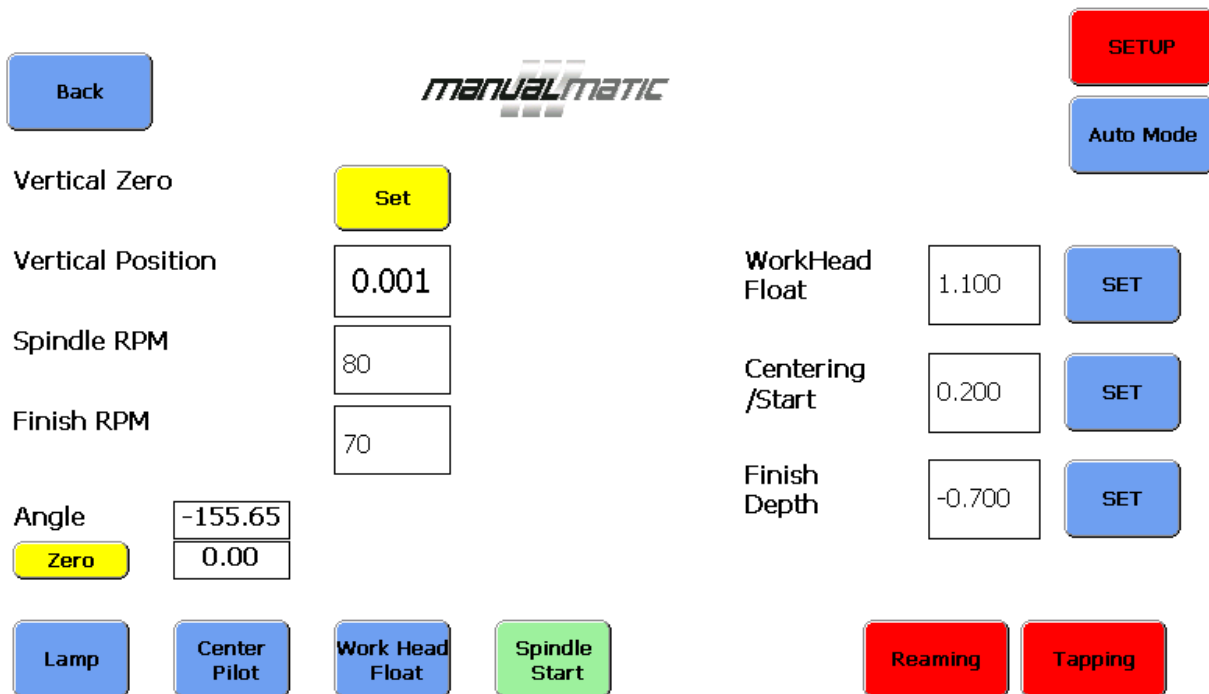

Buttons

BACK - goes 1 page back.

VERTICAL ZERO - tap the SET button to set the vertical spindle height.

VERTICAL POSITION - height spindle is at from VERTICAL ZERO height set.

SPINDLE RPM - tap the box and a keyboard will pop up, enter RPM you would like to run and tap enter.

FINISH RPM - this will be activated as soon as spindle reaches finish cutting depth. Set same as above.

ANGLE - this is the actual angle the angle sensor is in.

ZERO - buy taping this button you can ZERO the angle reading for easier setup.

LAMP - turns ON and OFF the LED work lights

CENTER PILOT – locks and unlocks the spindle sphere

WORKHEAD FLOAT - floats the workhead

SPINDLE START - turns ON and OFF the spindle

SET UP – turns off auto mode for setup

AUTO MODE - turns on MANUALMATIC mode

WORKHEAD FLOAT – Vertical height the spindle is at when workhead will float. Set buy taping the set button, or tapping display box and entering height wanted.

CENTERING/START – Vertical height the spindle will be at when the workhead centers itself on pilot. As soon as workhead clamps the spindle will start. Set buy taping the set button, or tapping display box and entering height wanted.

FINISH CUTTING DEPTH - Depth Finish RPM activates. Set by tapping the display box and entering in the amount you want to remove from the seat.

TAPPING – locks spindle sphere, instantly reverses spindle at finish cutting depth, will also change to FINISH RPM.

REAMING – locks spindle sphere for reaming and drilling.

MANUALMATIC Operation

1. Level cylinder head, set all tooling and install in spindle.
2. Tap the SETUP button, this turns off the AUTO MODE for setting up.
3. Press WORKHEAD FLOAT so workhead is floating. Float over guide and lower tool holder until cutter is touching seat and press the VERTICAL ZERO, “SET” button. This will change the VERTICAL POSITION height display to read 0.000. The Vertical Zero height, this is the height all of the Auto functions are set off of.
4. Next raise the spindle all the way to the top, then lower about 1/2” and press the WORKHEAD FLOAT “SET” button, anything above this height the workhead will be clamped, below it will float.
5. Next lower the spindle down to about 1/2” above the VERTICAL ZERO height and press the CENTERING/START “SET” button, when this height is met the spindle will center itself on pilot, clamp and spindle will turn on.
6. NOTE: The default settings for WORKHEAD FLOAT and CENTERING/START will work for most heads. You can also tap the display box and enter in a height manually if wanted.
7. Next manually set the amount needed to be removed from seat buy taping the FINISH CUTTING DEPTH “display box” and entering in the amount you want to remove, you must make this a negative number as it will be below the VERTICAL ZERO.
8. Raise spindle to the top and then turn on the AUTO MODE. You’re ready to cut.

NOTE: each time a height is met the LED WORK LIGHTS will flash.

- When spindle is lowered it will automatically float when the WORKHEAD FLOAT height is met.
- When you reach the CENTERING/START height it will automatically dwell to center, clamp and start spindle. Remove hands from steering wheel when lights flash for perfect centering.
- When finish cutting depth is met the spindle will automatically change to the FINISH RPM previously entered.
- When raised it will automatically float and stop spindle at the CENTERING/START height.
- This program will be saved automatically. All you will need to do is set your vertical zero.

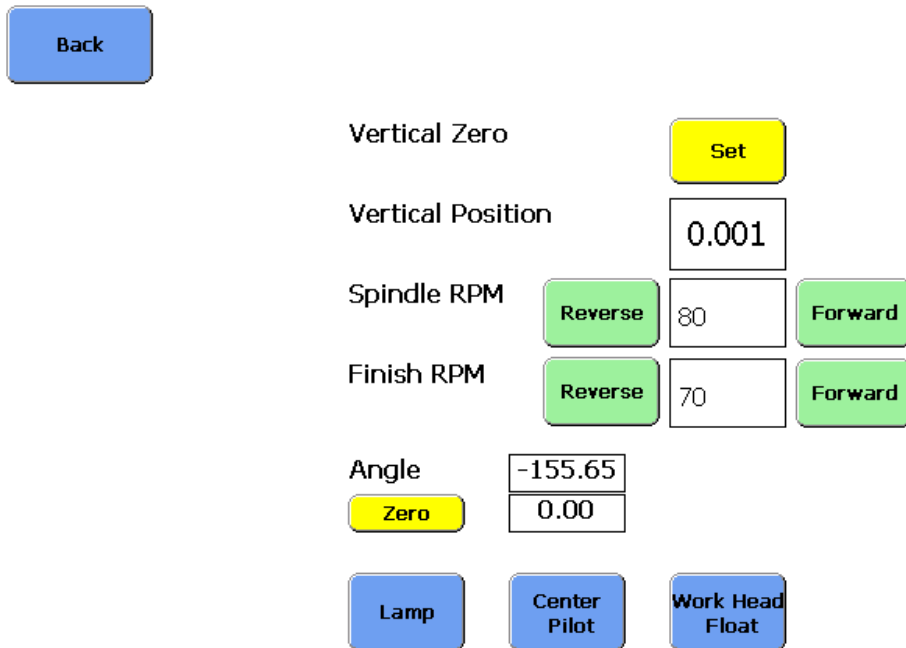
MANUAL**MANUAL****Buttons**

BACK - goes 1 page back.

VERTICAL ZERO - tap the SET button to set the vertical spindle height.

VERTICAL POSITION - height spindle is at from VERTICAL ZERO height set.

SPINDLE RPM REVERSE – runs spindle Counter Clockwise

FORWARD – runs spindle Clockwise

Tap display and enter desired RPM

FINISH RPM – same as above, you can instantly change RPSMs to the programed setting buy tapping the forward or reverse button. You can instantly change from forward to reverse if needed.

ANGLE - this is the actual angle the angle sensor is in.

ZERO - buy taping this button you can ZERO the angle reading for easier setup.

LAMP - turns ON and OFF the LED work lights

CENTER PILOT – locks and unlocks the spindle sphere

WORKHEAD FLOAT - floats the workhead

Operation Tips before Machining Valve Seats

Clean valve guide with a brush to remove foreign matter.

Required spindle rotation speed will vary, depending on seat hardness. As seat hardness increases, so does the spindle speed will change. Some will require full speed

NOTE: If valve guides are so badly worn that the proper centering will be impossible, it will be necessary to replace that valve guide to achieve the a concentric valve seat.

See following suggested machining speed chart .

SEAT MACHINING SUGGESTED RPM CHART

VALVE SEAT DIAMETER		SPINDLE SPEED
INCH	METRIC	RPM
15/16"	24	175
1.000"	25.4MM	150
1.125"	29MM	150
1.250"	32MM	125
1.375"	35MM	100
1.500"	38MM	100
1.625"	41MM	100
1.750"	44.5MM	100
1.875"	47.5MM	75
2.000"	51MM	75
2.125"	54MM	75
2.250"	57MM	75
2.375"	60MM	50
2.500"	63.5MM	50

Valve Seat Machining Procedure

Seat Pocket and valve guide must be clean to ensure proper fit of the carbide pilot.

Select the correct Carbide pilot for the valve guide ID Diameter

At this point, the spindle and work head should be level according to the position of the cylinder head.

Fit the Rottler Tool Holder and pilot assembly into the spindle cone; make sure to align the locator pins before you fit it into the spindle adapter and push it until you feel that is lock.

The spindle has been engineered to allow ultra fast tooling changes.

Make sure the that spindle Self locking nut is in the off lock position; line up the two ears of the spindle adapter and insert into the spindle ISO 30 taper, the locking nut automatically will be on the lock position

To remove turn the self-locking nut to the left position, hold the spindle adapter, it may drop on the machine table. Damage will result

Changing Language

Press the screen in the lower right hand corner, then press the screen in the upper right hand corner to bring up the Machine Settings screen. Be sure to press the screen with your finger and not just tap it.

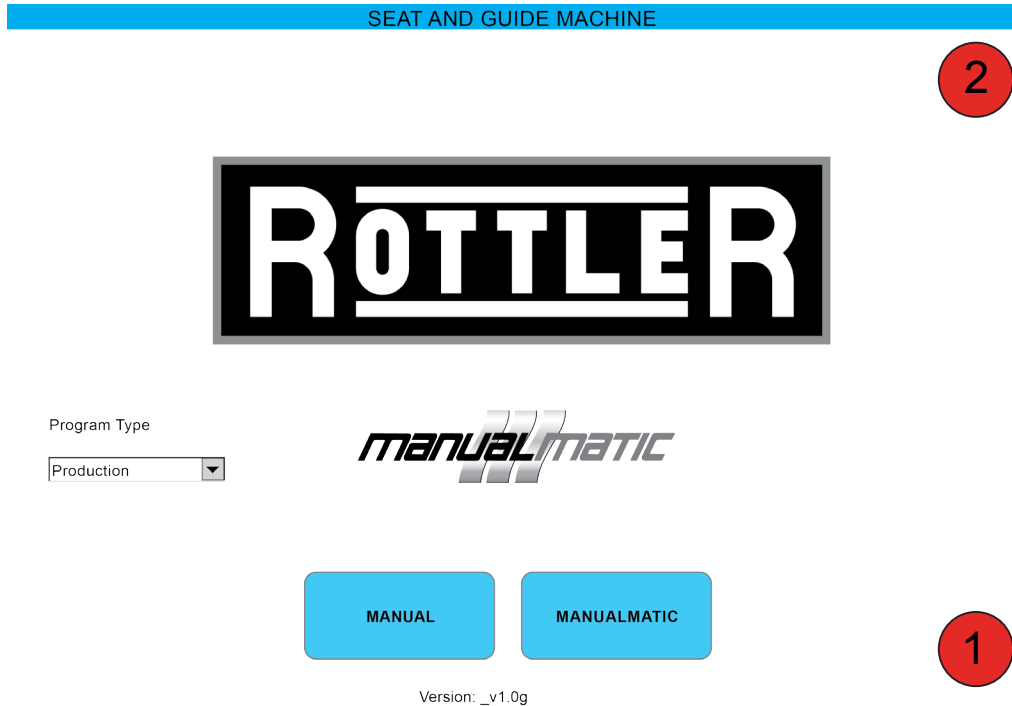

Press the Okay button on the pop up warning box to continue.

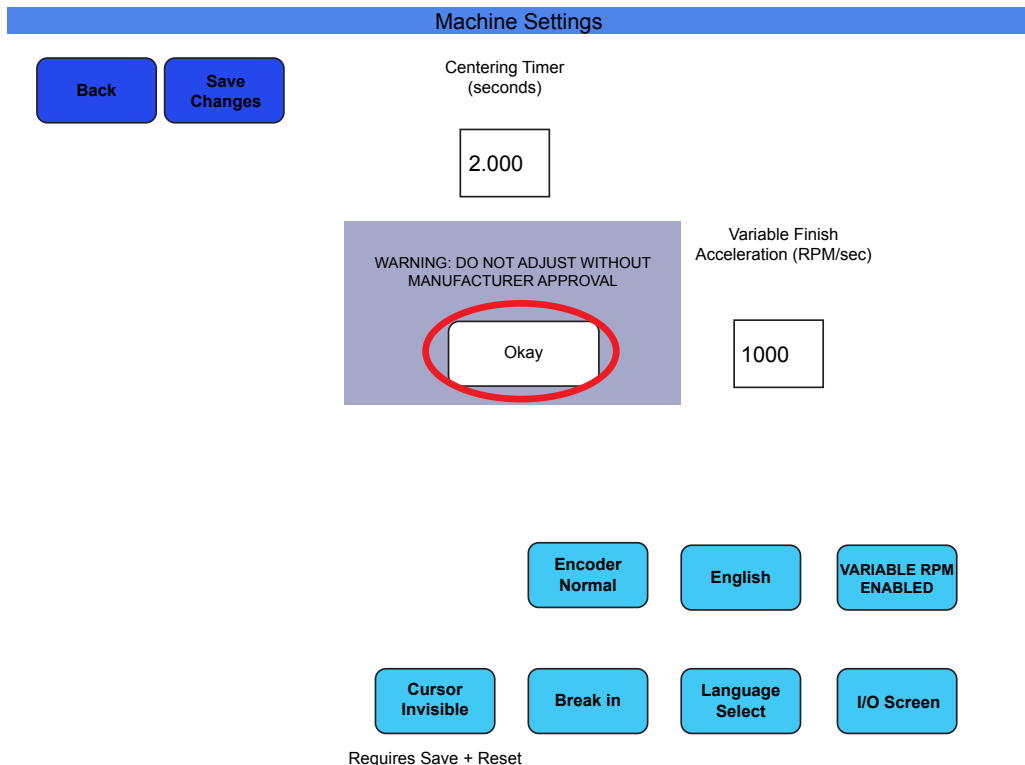

Press the Language Select button.

Machine Settings

Back **Save Changes**

Centering Timer (seconds)

Centering Timer 2 (seconds) Variable Finish Acceleration (RPM/sec)

Encoder Normal **English** **VARIABLE RPM ENABLED**

Cursor Invisible **Break in** **Language Select** **I/O Screen**

Requires Save + Reset

Select the language you want to switch to and press the button.

LANGUAGE SELECTION

CURRENT LANGAUGE USED: English

Confirm that the language you have selected is indicated and then restart the machine for the change to take effect. Turn the main power switch located on the electrical cabinet off and then back on to restart the machine.

LANGUAGE SELECTION

CURRENT LANGUAGE USED: GERMAN



YOU MUST RESTART.

Back



UNIPILOT Centralizing Pilots

Rottler UNIPILOT Solid Carbide Centralizing Pilots are manufactured from fine grain, sintered tungsten carbide and are ground to a very high degree of accuracy, straightness, and surface finish. They are designed for a lifetime of precision machining

Pilot Diameter

The straight/parallel part of the pilot that fits in to the valve guide is referred to as the pilot diameter. Rottler pilots are available in 0.01mm (0.0004") increments. For best results, the clearance between the pilot and valve guide should not be more than 0.01mm (0.0004")

Most new valve guides are manufactured to a nominal size and the valve stem diameters are manufactured to be smaller than the nominal size to allow clearance for heat expansion of the valve stem when the engine is operating. For example: a 7mm valve guide has an internal diameter of exactly 7.00mm (.2756") The valve stem diameter of the intake valve is 6.98mm (.2748") and the exhaust is 6.96mm (.2740"). In order for the pilot to fit most of the valve guides, the first choice could be UCP0699 to give .01mm (0.0004") clearance. If the valve guide is used and has some wear, then the second choice of pilot could be UCP0700 (0.2756").

Shank Diameter

The part of the pilot that fits inside the tool holder is referred to as the shank. Rottler offers three different shank sizes (6.00mm, 9.52mm, and 20.00mm). For longest tool life and best seat cutting results, the shank needs to go as far as possible inside the tool holder when cutting valve seats or boring out valve seat housings.

Extended Length (EL) Pilots

Some cylinder heads require extended length pilots because the distance from the top of the valve guide to the head gasket surface is longer than normal. Normally this distance is about 1.0" - 1.5", it is when this distance becomes greater that extended length pilots are needed. The pilots are extended by adding material below the shank and above the tapered section of the pilot.

If you think you need an extended length pilot, please see the order form in the back of the catalog and contact Rottler for ordering assistance.



PILOT DIAMETER SHOULD ALWAYS BE GREATER THAN VALVE STEM DIAMETER FOR BEST CONCENTRICITY

Modular Carbide Centralizing Pilot System for Valve Guides Over 0.875" (22.23mm)

Rottler also offers a modular carbide centralizing pilot system for very large engine applications. This system is versatile because it allows you to use different size sleeves, which are adjustable for different lengths, for different applications while using only one pilot. These sleeves are MADE TO ORDER. Contact Rottler for more information and ordering assistance.



FCM20EL380

Modular Carbide Centralizing Pilot for Valve Guides Over 0.875" (22.23mm). Requires a set of Interchangeable Sleeves (FCMSLXXX & FCMSUXXX) - 20mmShank Pilot

FCMSUXXX

Modular Pilot Upper (Tapered) Sleeve - Hardened and Heat Treated - For .XXX" (XX.XXmm) Guide ID

FCMSLXXX

Modular Pilot Lower (Straight) Sleeve - Hardened and Heat Treated - For .XXX" (XX.XXmm Guide ID - 3.0" Overall Length

Unipilot Tooling

Rottler's patent pending UNIPILOT tooling system allows the UNIPILOT carbide centralizing pilot to remain in the spindle when moving from guide to guide like a live pilot machine, but at the same time has a fixed pilot design to give the best concentricity. This system offers the speed of a live pilot machine, with the accuracy of a fixed pilot machine.

It is a common known fact to engine rebuilders that all valve guide centerlines are not at the same exact angle. The sphere in the UNIPILOT tooling system allows compensation for minor inconsistencies as the pilot is inserted in the guide, allowing the machine to quickly move from one guide to the next and automatically compensate for these inconsistencies to center the pilot accurately and give the best concentricity.

Due to demand from customers that needed the large size of the SG80 machines and the speed and accuracy of the UNIPILOT system, Rottler has developed four new parts that bring this time saving feature to the SG80A and SG100M.

The RBHAR40UPT2 spindle adapters and UPT5200SH and UPT5400SH spherical tool holders are what make the use of the UNIPILOT system possible on the SG80 models. These tool holders use .375" (9.52mm) shank UNIPILOTS and are spring loaded to help get the pilot into the guide easily and quickly. If the pilot misses the guide as the spindle moves downwards, the pilot will compress upwards into the toolholder and will quickly release and insert the pilot in the guide once it is located inside the guide.

The adapter and tool holder must be fixed together to prevent them from separating as the pilot is moved in and out of the guide. This is done simply with two set screws on either side of the adapter. Switching tool holders on these adapters takes only a few seconds.

For high volume production applications, Rottler recommends having multiple adapters and tool holders preassembled with UNIPILOT and cutting tool to facilitate the quickest possible tooling change when going from intake to exhaust seats or even for different heads.



RBHAR40UPT and UPT5400SH assembled. Note one of the two screws (center) that locks them together

How to Use UPT Series Uipilot Toolholders

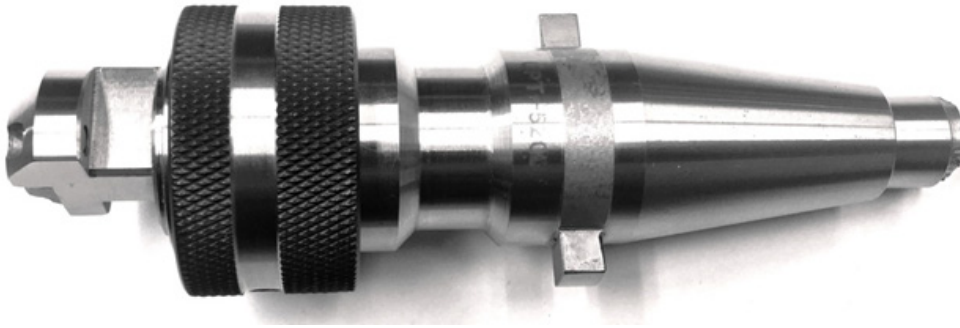

1. Pilot shank and toolholder Inside Diameter for the pilot shank must be clean from cast iron dust, few drops on lite oil may be necessary at least twice a day.
2. Measure pilot shank diameter for wear, it's supposed to be .3758" - 9.545mm. The shank should not have more than .0007" - .0178mm of wear less the shank diameter of .375"-(9.525mm) diameter.

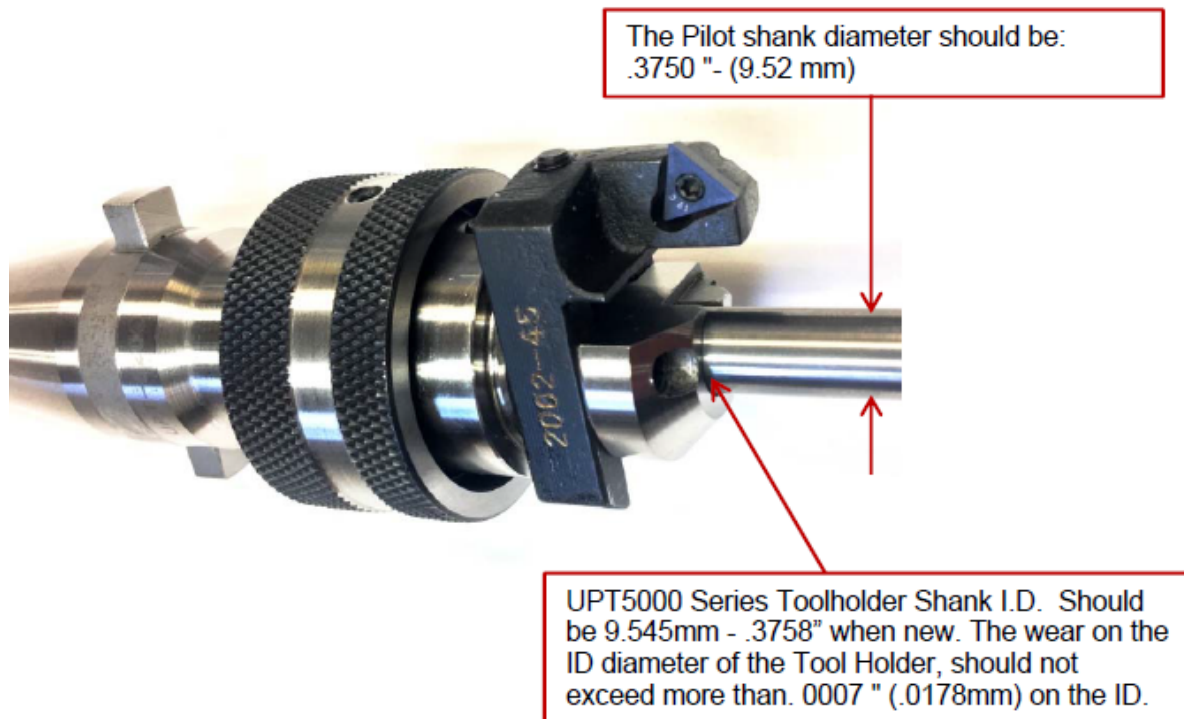

3. The UPT5200 Series toolholder shank ID it supposed to be 9.545mm - .3758" when new. The ID diameter should not be more than .0010" - .0254mm of wear.

Note: Please make sure to follow these inspections to avoid concentricity problems on every valve seat that has been machined.

4. Is very important not to over tighten the "C" Looking screws that lock the insert holder on the Toolholder, tightening the locking screws will collapse the ID bore diameter on the toolholder keeping the shank of the pilot not to fit easy into the Toolholder ID.

This is the correct way to lock the Insert holder using the long part of the Allen wrench like you see on the picture below to avoid too much torque and collapse the Pilot shank ID Bore of the Toolholder.



For safety please avoid overtighten the insert holder, it will be better to use the 2.5mm Ball End Metric Screwdriver like the one you see on the picture below.

The 2.5mm Ball End Metric Screwdriver will work to lock the insert holder and it will also to adjusting screw to set the diameter for the seat that you will be machining.



On the Picture below is showing the wrong way to Lock the Insert holder, will put too much torque and collapse the Pilot shank ID bore of the Toolholder. The Pilot shanks will not slide smoothly into the toolholder shank inside diameter; it will create excessive wear on the toolholder and possible over tolerance in concentric limits problems when machining the valve seat.

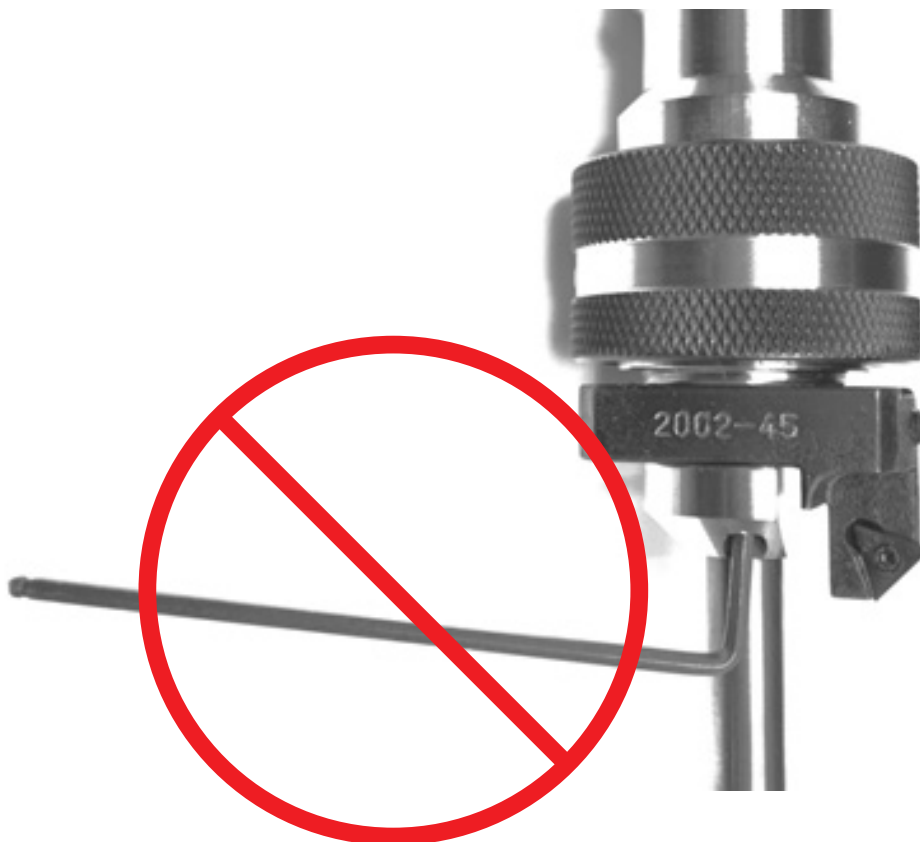

Using the Unipilot System for the UPT5200 / UPT5400 Series Tool Holders

1. Insert standard 3/8" (9.52mm) shank UNIPILLOT into the cylinder head valve guide.
2. Place checking gage next to Pilot shank to inspect range.
3. If pilot is within MIN. and MAX. range of the checking gauge, (Figure 3) proceed to machine seat inserts after removing gage from the cylinder head.
4. In case pilot height exceeds MAX. limit of the gauge. Inspect valve guides and ream guide if need to be or use proper pilot size diameter till pilot height is within tolerance of the checking gauge.
5. In case pilot is below the MIN. limit of the Gauge, select next size up pilot until pilot height is Gauge within tolerance.

MAXIMUM AND MINIMUM PILOT HEIGHT FROM HEAD SURFACE

Figure 1

On the picture below you will see that the Pilot shank is above the Pilot Gauge. This will damage the Toolholder



Figure 2

On the picture below you will see that the Pilot shank is minimum on the Pilot Gauge mark. If it's below the minimum will create poor centering and possible concentricity problems



Figure 3

On the picture below you will see that the Pilot shank is within the MAX and MIN range of the Pilot Height Gauge. This is the correct pilot to be used to machine the valve seats



Rottler Six and One Instructions



- 1- Checking the calibration of the six and one Setting Fixture included two tool setting fixtures, 1.250" / 31.750MM and .375" / 9.52MM and on the other end is 6.00MM. On the picture you will see master setting tool (.375" / 9.52MM) this one also will be using it to set you tool holders, for .375" (9.52mm) and 6.00MM ID tooling.,

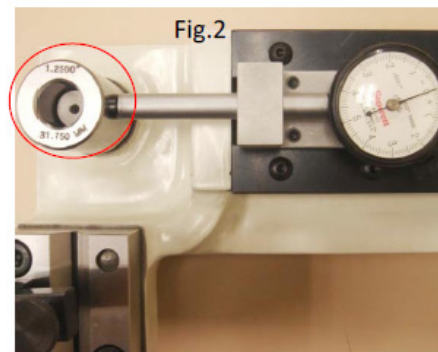
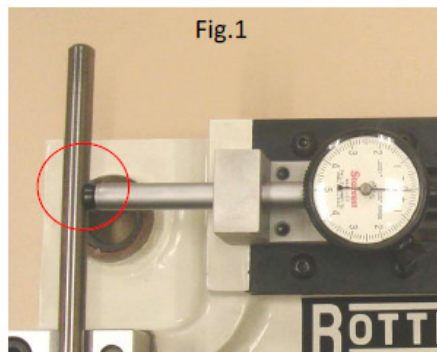

Calibrating the Digital Micrometer

- 2- Turn the digital micrometer thimble in until the end of the micrometer is flush with the edge of the micrometer frame. Then turn the thimble out until the '0' mark on the thimble lines up exactly with the line on the barrel (see fig.1).



- a. Select mode: Press the **mm/in** button until the desired mode is shown in the digital display.
Note: use a small instrument such as a pen to gently push the buttons; they are quite small and a bit delicate.
- b. Determine which calibrating setting tool you will be using to calibrate the micrometer is going to be used on. (example; calibrating pilot .375" / 952mm side)
- c. Press and hold the **SET** button, then press + or – button. "SET" will be flash in the display. This will place the micrometer in the edit mode
- d. Press and hold the + or – buttons to change the display number to the minimum set diameter Determined earlier (example; setting tool, pilot .375" / 9.52mm side).
- e. After it reach the proper reading, press the **SET** button to exit the edit mode. "SET" should no longer be shown in the display. The digital micrometer head is now set to the setting tool. (After initial setting, there is no need to press the SET button again unless display is lost at which time the micrometer must be reset)

3- MEASURE THE HEAD OF THE VALVE

- a. Position the Valve Stem on V Block and bring the Indicator tip to may contact with the head of the Valve until zero show on the indicator dial, the amount showing of the digital micrometer display is the actual diameter of the Head of the Valve.
- b. From that reading 2.0001"

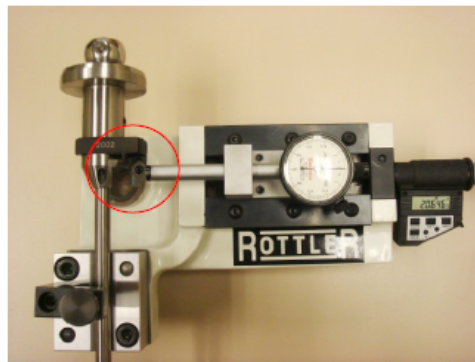
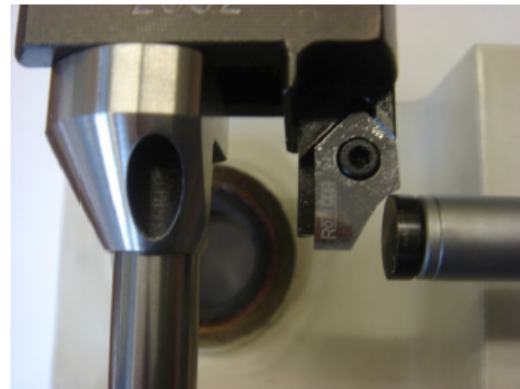
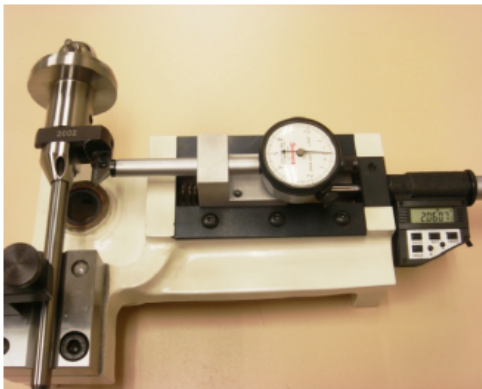
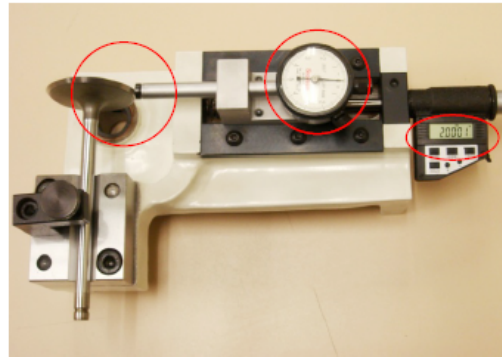

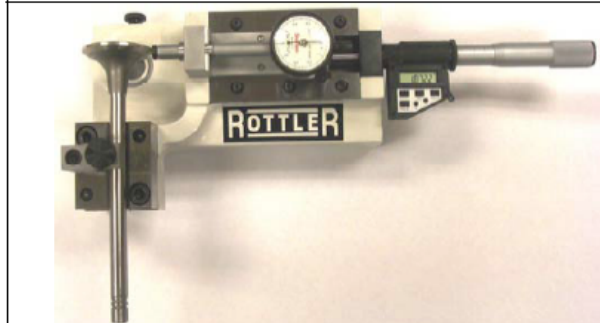

MEASURE VALVE HEAD DIA

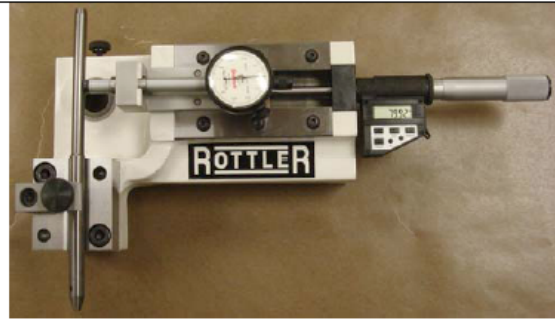

MEASURE VALVE STEM AND PILOT DIA.

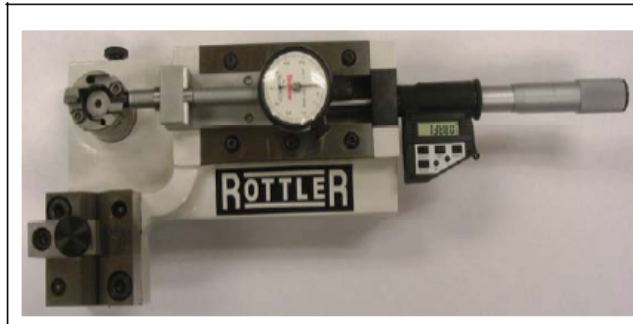

SET ADJUSTABLE DOUBLE INSERT MILLING CUTTERS

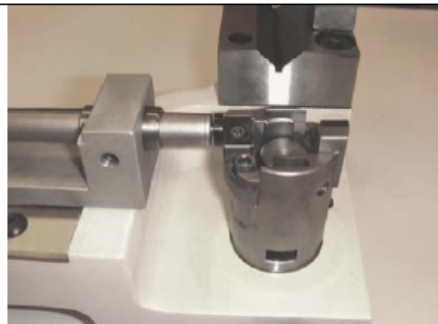

SET ADJUSTABLE DOUBLE INSERT MILLING CUTTERS

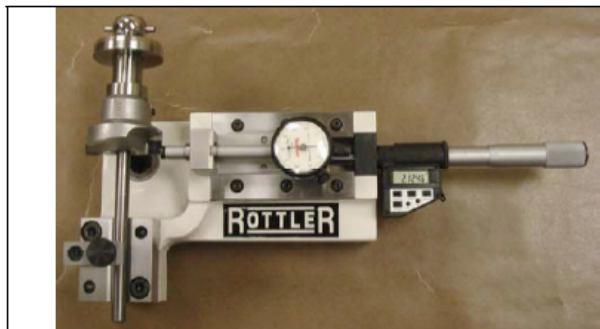

SET BORING INSERT FOR HOUSING DIA.



SET BORING INSERT FOR HOUSING DIA WITH TRIANGLE

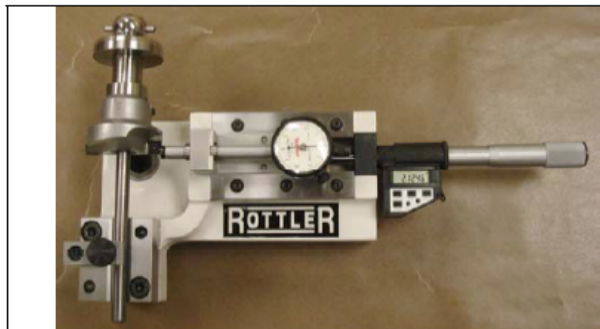

SET BORING INSERT FOR HOUSING DIA.



SET BORING INSERT FOR HOUSING DIA

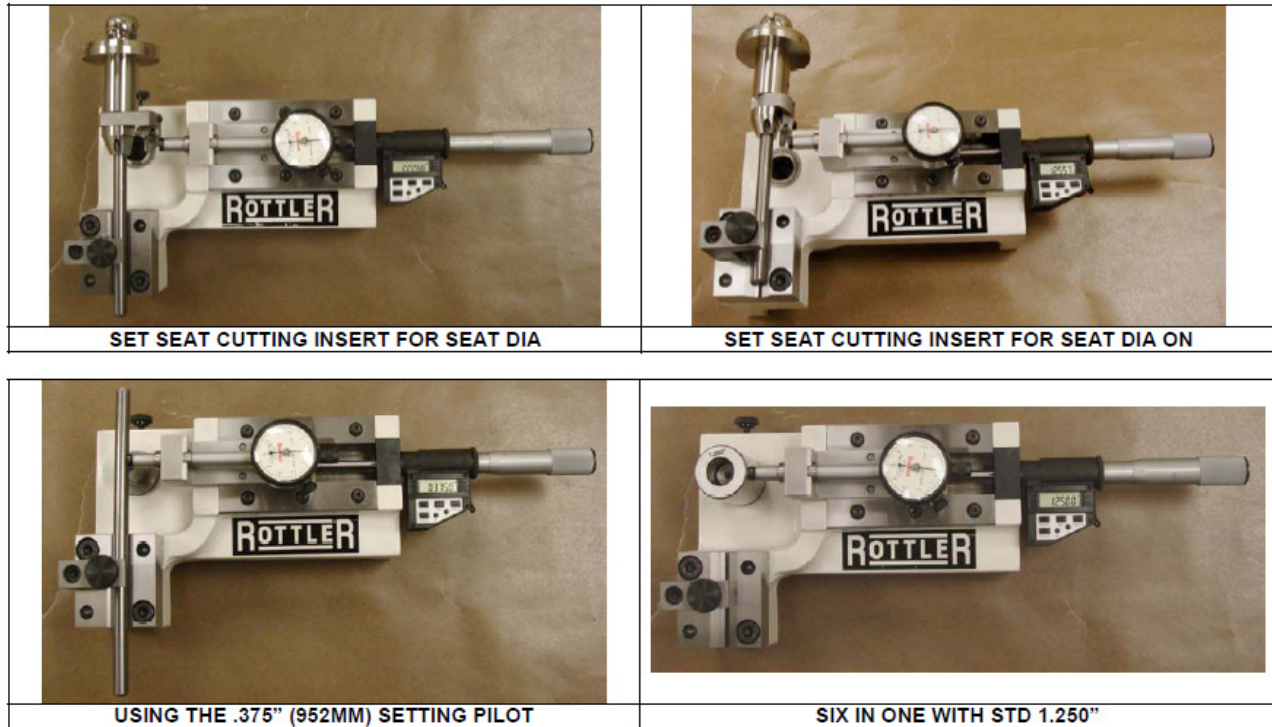

Adjusting the Square Carbide Inserts

- The micrometer should be used.
- Set the Digital micrometer (BM) according to the valve seat insert diameter and the required interference.
- Slide the tool holder without the pilot on the micrometer.
- With the setting screw, adjust the square tip holder offset.



IMPORTANT: When 90 degree bits (RCA512) or the Triangle bits are fitted, check that their reference faces are perfectly clean.

The accuracy of the seat angles depends on this.

While rotating the assembly tool holder/carbide tip holder, the carbide bit's cutting edge should just touch the micrometer spindle.

Once in contact with the micrometer spindle, the carbide tip should not be moved at all. If this is not observed, the cutting edge may be damaged and the resulting surface quality, when machining, will be deteriorated.

Cutting Small Diameter Valve Seats

The UPT5200 adapter has a set screw as shown in photo below – push pilot all the way into the UPT5200 and tighten set screw to hold pilot inside the UPT5200. Install the Tip Holder TH1999, adjust diameter, release set screw, and remove pilot. Be sure to use special small diameter cutting inserts such as RCA625 or RCA628 where the seat is close to the pilot side of the insert.



Tooling for Counterboring Small Diameter Valve Seat Pockets

Rottler offers two options for counterboring small diameter valve seat pockets:

6 mm Pilots Boring Combos

BH600R1 Mini Spherical Toolholder
TH2000-00 Tip Holder
RT211 Triangular Insert
Bore diameter: 1.055" – 1.400" (26.80 mm – 35.55 mm)



BH600R1 Mini Spherical Toolholder
TH1999 Tip Holder
RCA513 Seat Cutting Insert
Bore diameter: .800" – 1.200" (20.80 mm – 30.48 mm)



.375" Pilot Combos

BH375R1 Spherical Toolholder
TH2000-00 Tip Holder
RT211 Triangular Insert
Bore diameter: 1.270" – 1.580" (32.26 mm – 40.15 mm)



BH375R1 Spherical Toolholder
TH1999 Tip Holder
RCA513 Seat Cutting Insert
Bore diameter: 1.000" – 1.280" (25.42 mm – 32.51 mm)



Rottler can also provide Fixed Milling Heads to cut valve seat pockets. They are available in fixed diameters from 1.000" to 2.250" in .0625" increments

This page intentionally left blank

MAINTENANCE

Contents

Maintenance.....	6-1
Quick Reference Lubrication Chart:	6-1
Preventative Maintenance Quick Reference Chart:	6-1
Air Adjustments:.....	6-2
Float:	6-2
Float surfaces:	6-2
Work Head Air Float Adjustment.....	6-3
Calibrating the Digital Level:	6-4
Rebuilding the UPT5200 Unipilot Holder.....	6-5
Adjusting and aligning the outer spindle on SG models.....	6-7
Adjusting outer spindle clearance.....	6-8
Spindle Lock Nut Service Procedure.....	6-9

Maintenance

Quick Reference Lubrication Chart:

Refer to the maintenance section in the manual for lubrication location points and instruction.

Assembly	Frequency	Lube Operation	Recommended Lubricant	Date Serviced
Outer Spindle	8 Hours	Clean and Wipe with oil	ISO VG 68 Way Oil	
Brass guide shoes/slide	500 Hours	Clean and wipe with oil	ISO VG 68 Way Oil	
Grease spindle Rack and pinion	500 Hours	Clean and grease	NLGI #2 White Lithium Grease	
Grease spindle worm wheel and worm shaft	500 Hours	Clean and grease	NLGI #2 White Lithium Grease	
Grease spindle drive shaft	500 Hours	Clean and grease	NLGI #2 White Lithium Grease	
Grease rollover clamp fixture bearings	200 Hours	Clean and grease	NLGI #2 White Lithium Grease	
Grease clamp fixture Pins and Acme screw	200 Hours	Clean and grease	NLGI #2 White Lithium Grease	

Preventative Maintenance Quick Reference Chart:

Refer to the procedures in the maintenance section of the manual to make or check these adjustments. Not all of the items listed in the table below have adjustment. The information should be recorded and the amount of wear tracked so the part can be replaced before down time on the machine occurs.

Procedure	Frequency	Date Serviced/Comments
Clean top and bottom float tables	8 Hours	
Outer Spindle Bushing Adjustment	500 Hours	
Brass Shoe Adjustment	500 Hours	
Angle sensor calibration	500 Hours	
Spindle Drive Belt Adjustment	1000 Hours	
Adjust workhead clamp plate bearings	1000 Hours	
Rack and pinion adjustment.	1000 Hours	
Machine Level Adjustment	1000 Hours	

CAUTION

All floating surfaces should be dry and clean do not oil the surfaces, oil will cause the work heat not to float properly.

Air Adjustments:**Float:**

The float regulators are located on the left side of machine base. Marked “Work Head Air Float Adjustment” If the work head is not floating properly it could be from too much or too little air from the regulator. Starting with all regulators set at 1 bar with “workhead float” button activated, slowly turn all up .5 bar at a time until workhead start to float. Pushing work head front to rear checking for stiff spots. If workhead is dragging in the forward position, (workhead pulled closest to operator) raise the 2 front regulators 1 mark until it floats without dragging. Same for rear. You may have to go back and forth a few times to get this correct. If workhead is not dragging lower the PSI until it does and then raise 1 notch at a time until it is free. Typically the front two regulators will be slightly higher than the rear two. Once the correct float is established lock the regulators in place by pushing in on the blue adjusting knob

CAUTION

Use as little air as possible to achieve correct floatation. Using too much air will could cause the spindle base to vibrate and not center properly on the on the pilot.

Float surfaces:**CAUTION**

Wipe clean daily

All floating surfaces should be dry and clean do not oil the surfaces, oil will cause the work heat not to float properly.

Work Head Air Float Adjustment

ADJUSTMENT OF WORK HEAD AIR FLOAT

FIG.1

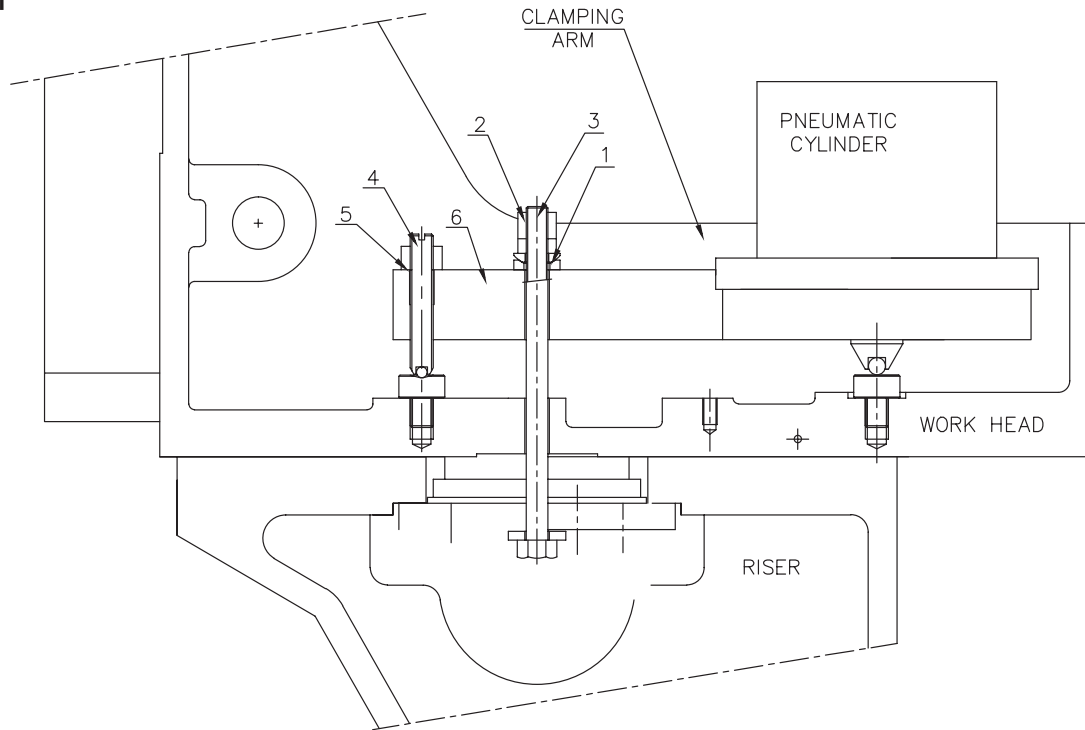
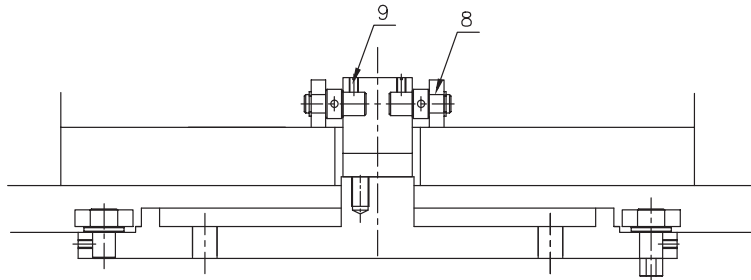

FIG.2



ADJUSTMENT PROCEDURE:

1. LEVELLING OF RISER TOP SURFACE PLAYS A CRUCIAL PART IN STABILITY OF WORK HEAD THEREFORE LEVEL THE RISER TOP SURFACE PROPERLY.
2. IT IS DIFFICULT TO PIN POINT THE REASON FOR WORK HEAD JUMPING TO THE REAR. BEST ACTION WILL BE TO ADJUST THE CLAMPING ARMS.
3. LOOSEN FOUR GRUB SCREWS (9). AIR FLOAT WORK HEAD & ADJUST FOUR BEARINGS (9) IN SUCH A WAY THAT THE CLAMPING PLATE IN RISER SLOT DOES NOT TOUCH THE RISER CLAMPING SURFACE. BEARINGS CAN BE ADJUSTED BY ROTATING THE BEARING PINS WHICH ARE ECCENTRIC (FIG 2).
4. CHECK SPHERICAL WASHERS FOR ANY DAMAGE. IF NECESSARY, REPLACE THE SAME.
5. CLAMPING ARM SHOULD BE FAIRLY LEVEL. THIS CAN BE DONE BY LOOSENING CHECK NUTS (5) & ADJUSTING GRUB SCREWS WITH BALL (4). FOR DOING THIS LOOSEN NYLOCK NUTS (2).
6. TIGHTEN NYLOCK NUT ON CLAMPING BOLT (3) WITH AIR FLOAT ON. THEN TURN OFF 1 OR $\frac{1}{2}$ TURNS BACK.
7. CHECK LOCKING & FLOAT OF WORK HEAD. RE ADJUST IF REQUIRED.
8. ADJUST PRESURE RAGULATOR FOR WORK HEAD TO HAVE UNIFORM LIFT OF WORK HEAD, WHEN AIR FLOATING .
9. TO ENSURE THAT AIR FLOAT HOLES IN THE WORK HEAD ARE NOT CLOGED, MOVE WORK HEAD IN FRONT AS WELL AS THE REAR OF THE RISER. GIVE AIR PRESURE TO SEE THAT AIR FLOWS FREELY IN BOTH POSITION.

Calibrating the Digital Level:

NOTE: Even though the level has been carefully calibrated at the factory, it is a good idea to recheck calibration before putting the machine into service. In the event that the level is dropped or handled roughly then the following recalibration methods should be implemented.

The level assembly is referenced to the spindle via the level pin. It is important to check alignment of pin in reference to the spindle. This is accomplished by mounting a magnetic base dial indicator to the machine spindle and sweeping the pin vertically by raising or lowering spindle to check alignment. Pin alignment should be checked in two positions at 90 degrees to each other. If the pin alignment needs correcting, do so with the set screws located at base of pin block.

Install level on pin. Orient level to read left to right. Tilt head left or right until level reads 0.00. Now rotate level 180 degrees. The reading should be 0.00, if not then it will be necessary to calibrate the inclinometer to the level body. This is accomplished by loosening the inclinometer's two retaining screws and pivoting the inclinometer until it repeats when level is rotated 180 degrees.

Example: level reads 0.04 to the left, when rotated 180 degrees to the right it should read minus 0.04.

Check the level reading with the pickup oriented front to back. It should read 0.00 if the machine has been properly leveled with a machinist level.

If the readout does not read 0.00 then chances are the machine's leveling procedures have not been properly followed or there are internal problems with the levels electronics.

The sensitivity of the level is so great that it may not zero totally, even while the machine is not being touched. The alignment tolerance for installing guides is plus or minus .05 degrees, and for forming three angle seats is plus or minus .1 degrees.



Rebuilding the UPT5200 Unipilot Holder

Align the pin and push through until you are able to get the sleeve up and remove the components to replace.

To remove the cap unscrew the cap, this cap has left-hand threads; remove the long spring with the spacing Rod and the Trust Pad (See pictures below)

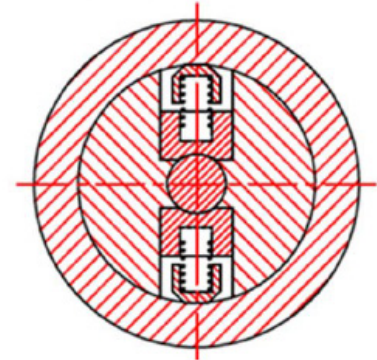
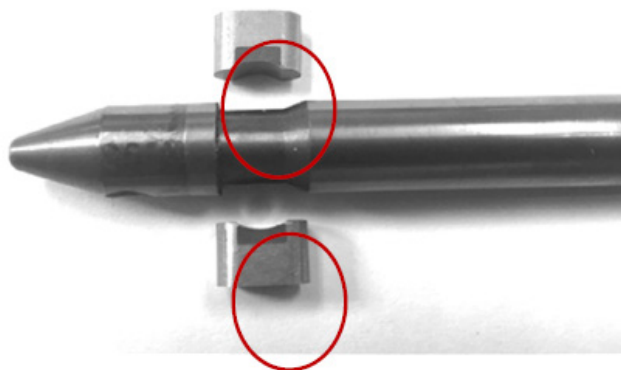
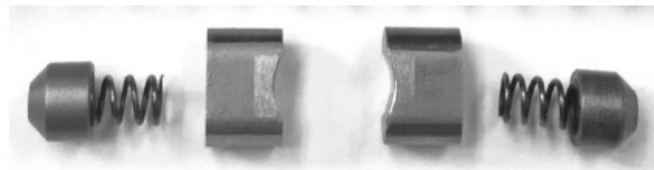
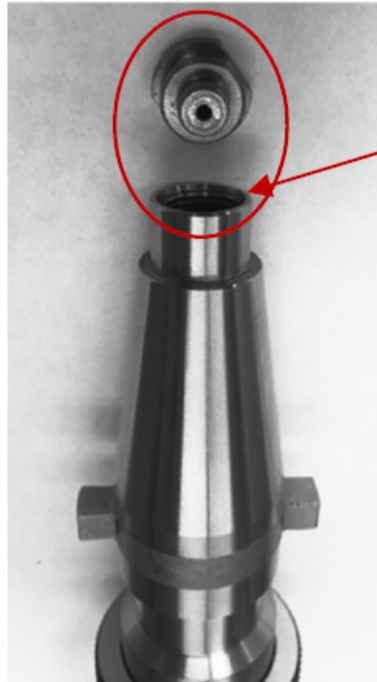
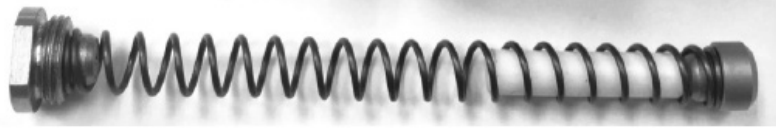

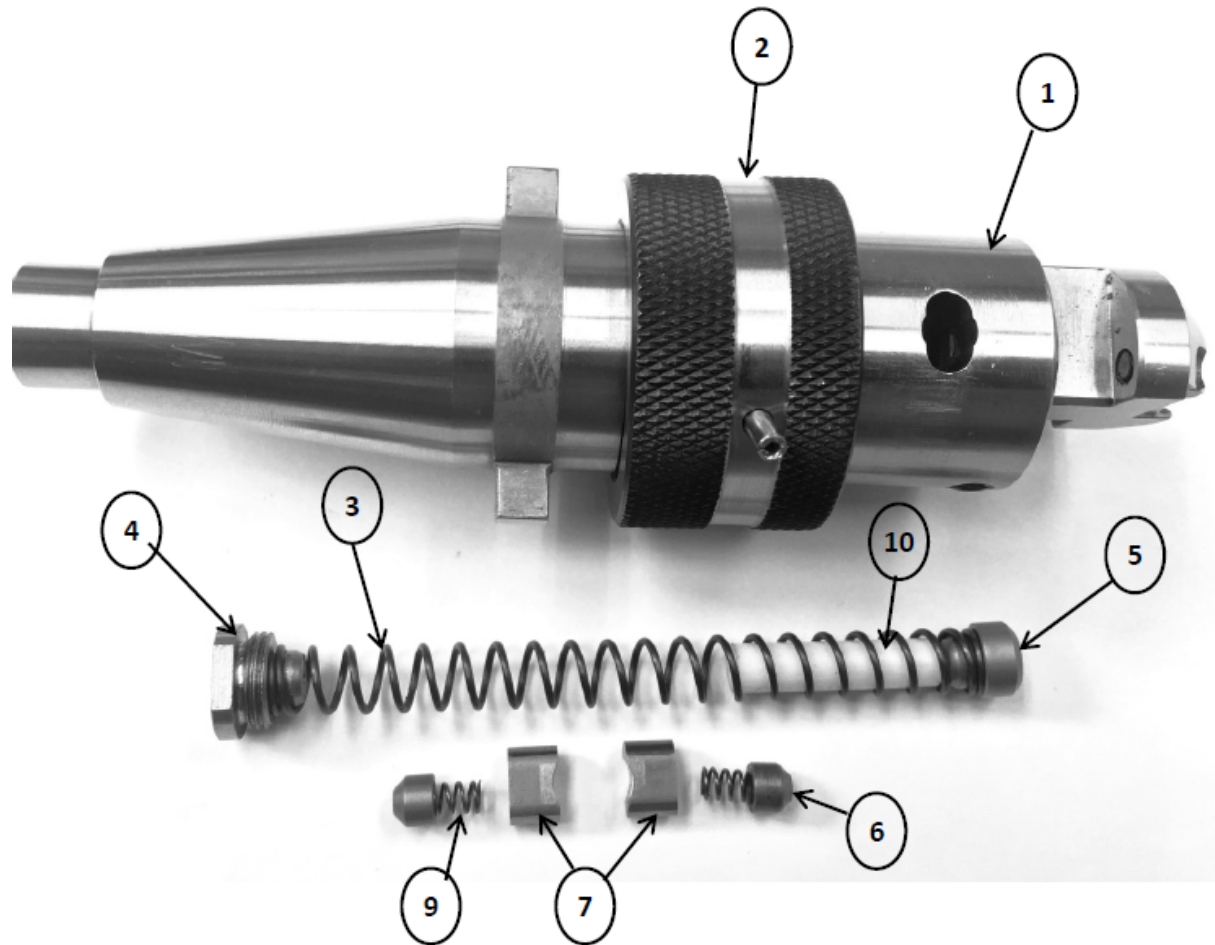

UPT5200 Rebuilding Kit Parts Details

Sr. No.	Part No.	Description	Qty.
1	5201	Toolholder Body Only (UPT5200)	1
2	5207	Toolholder Adapter Collar	1
3	555-19-10	5203-1 – Spring Long	1
4	555-19-9	5202 - Holding Screw	1
5	555-19-12	5104 - Trust Pad.	1
6	555-19-2	5205-1 - Plunger Pin Outer	2
7	555-19-3	5205-2 - Plunger Pin Inner	2
8	UCPXXX	UNIPILOT.375" (9.52mm) Shank	1
9	555-19-4	5203-3 - Compression Spring	2
10	555-19-11	5209 - Spacing Rod	1

Adjusting and aligning the outer spindle on SG models

There are 2 brass guide shoes located on the guide plate on top of the spindle that align the rack gear on the back of the spindle with the pinion gear that moves the spindle up and down.

Lower the spindle to the center position of travel.

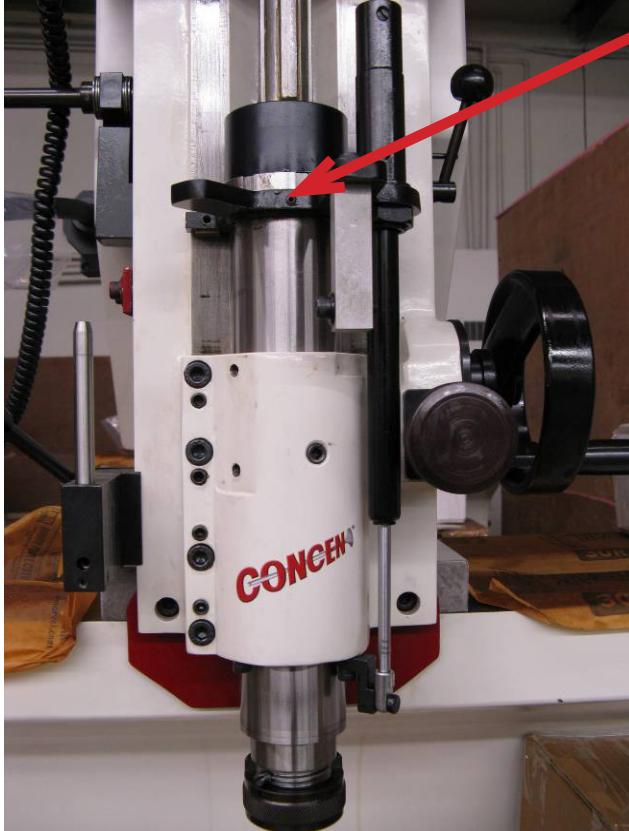

Check the guide plate at the top of the spindle, tighten if necessary.

Clean and lightly lubricate sliding guide surfaces with grease. Adjust brass guide shoes on guide plate so that there is no twisting movement. Run the spindle through its full travel to confirm that there is no binding.

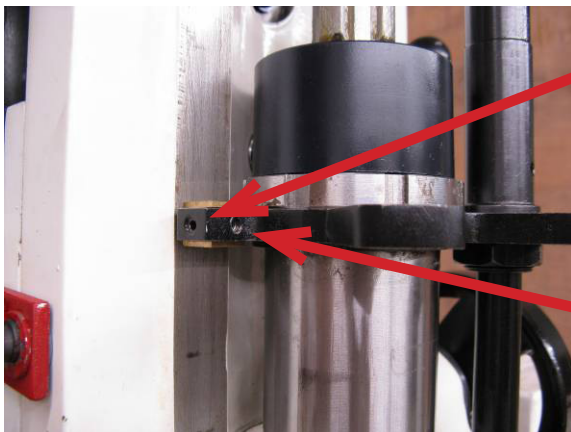

Loosen locking screw to adjust brass guide shoe. Tighten after adjusting.

Use adjusting screw to adjust brass guide shoe.

Adjusting outer spindle clearance.

Loosen the 4 lock bolts.



Loosen the 4 adjusting set screws.

Clean outer spindle and lubricate – add a few drops of oil to a clean cloth and wipe outer spindle.

Starting with the bottom set of lock bolt and adjusting set screws, tighten the lock bolt until there is drag on the spindle when it is move through its range of travel.

Then tighten the adjusting set screw until the amount of drag on the spindle is reduced to the point that there is a slight drag on the spindle through its range of travel.

You may have to make further adjustment to the lock bolt and set screw the get the spindle adjusted properly.

Repeat the above procedure the other 3 sets of lock bolts and set screws.

Spindle Lock Nut Service Procedure

SEAT & GUIDE MACHINE MODELS : SG-8MTS, SG-9MTS, SG-10X & SG-80MTS
 SPINDLE LOCK NUT ASSEMBLY & DISMANTLING INSTRUCTIONS.

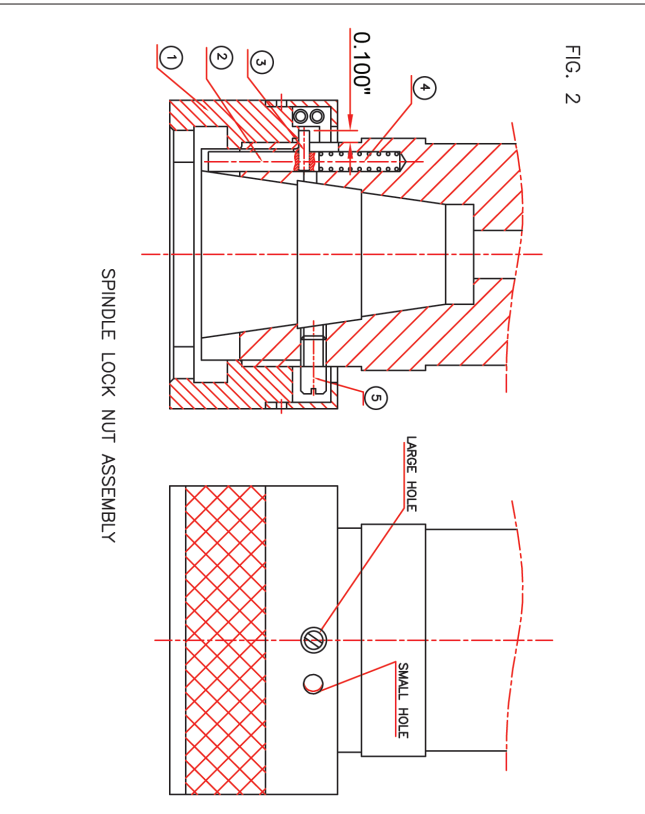
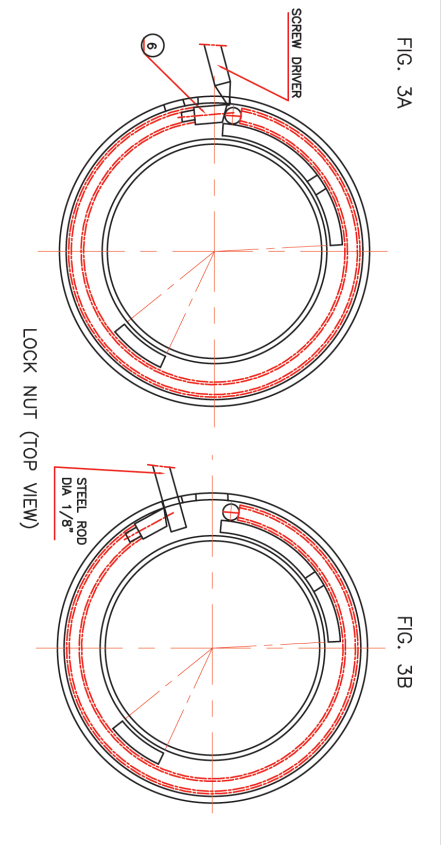
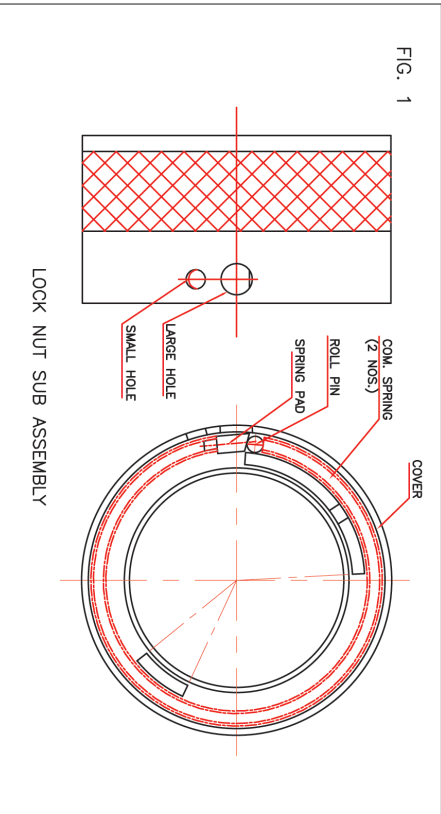

- ASSEMBLY OF LOCK NUT (REF. FIG. 2)**
1. INSERT SPRING '4' IN THE SPINDLE HOLE FOLLOWED BY PLUNGER PIN '2', KEEPING HOLE ON THE TOP SIDE.
 2. ASSEMBLE STOP PIN '3' BY PRESSING UP PLUNGER PIN '2' TILL THE PIN HOLE IN PLUNGER PIN '1' COMES OPPOSITE TO HOLE IN THE SPINDLE. THE PIN SHOULD PROJECT BY 0.100" (2.5MM) FROM SPINDLE SURFACE.
 3. START TIGHTENING LOCK NUT '1' ON THE SPINDLE. WHEN IT STOPS, PRESS THE PLUNGER PIN '2' AND CONTINUE TIGHTENING TILL THE LOCK NUT TOUCHES THE SPINDLE.
 4. UNSCREW LOCK NUT '1' SLIGHTLY TILL LARGE HOLE IN THE LOCK NUT COMES OPPOSITE THE TAPPED HOLE IN THE SPINDLE.
 5. WITH A SMALL SCREW DRIVER PRESS SPRING PAD '6' THROUGH LARGE HOLE SO THAT IT CLEARS THE SMALL HOLE. INSERT A STEEL ROD IN THE SMALL HOLE TO HOLD THE SPRING PAD '6' IN THAT POSITION. TAKE OUT SCREW DRIVER, REF. FIG. 3A & 3B.
 6. TIGHTEN STOP SCREW '5' IN THE SPINDLE THROUGH LARGE HOLE.
 7. RELEASE SPRING PAD '6' BY PULLING OUT THE STEEL ROD. THE LOCK NUT ASSEMBLY IS NOW COMPLETED. CHECK ITS FUNCTIONING MANUALLY BEFORE MACHINING.
- DISMANTLING OF LOCK NUT (REF. FIG. 2)**
1. ROTATE THE SPINDLE TO SEE IF LARGE HOLE IS OPPOSITE TO STOP SCREW '5'. IN CASE IT IS NOT SO, PRESS THE PLUNGER PIN '2' UPWARDS, THIS WILL BRING THE LARGE HOLE OPPOSITE TO STOP SCREW '5'.
 2. TAKEOUT STOP SCREW '5' BY UNSCREWING THE SAME.
 3. PRESS PLUNGER PIN '2' & START UNSCREWING THE LOCK NUT '1' TILL IT COMES OUT.
 4. PUSH STOP PIN '3' TO COME OUT OF PLUNGER PIN '2'.
 5. TAKE OUT PLUNGER PIN '2' AND SPRING '4'.
 6. DO NOT TEMPER WITH LOCK NUT SUB-ASSEMBLY. ASK FOR A NEW PIECE IF DAMAGED. SPINDLE LOCK NUT IS ALWAYS SUPPLIED IN SUB-ASSEMBLED CONDUCTION WITH TWO COM. SPRINGS, SPRING PAD, ROLL PIN & COVER AS SHOWN IN FIG. 1

TROUBLESHOOTING

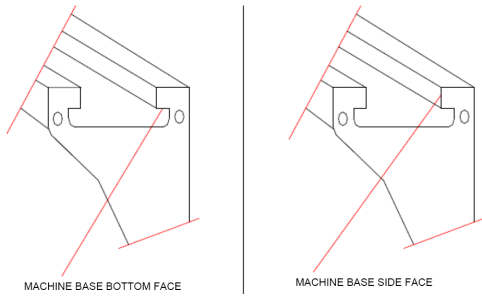
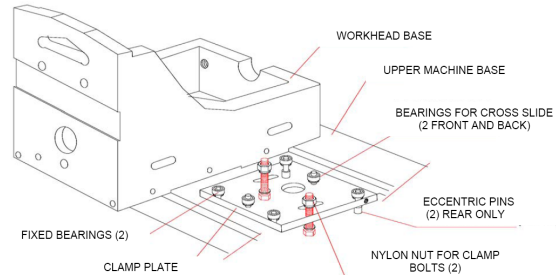
Problem	Possible Cause	Solution
<p>Workhead base does not float</p>	<p>Insufficient air pressure</p>	<p>Set air pressure of supplied line should be minimum 85 PSI (6 Bars)</p>
	<p>Clamping plate does not drop when unclamped due to less clearance between upper floating base and ball bearings mounted on clamping plate</p>	<p>Take the workhead to one end of the of the upper floating surfaces (Left or Right side) float the workhead and pull it against the front on the T Slatted guide surfaces, then loose the set screws of the eccentric pin to increase clearance by using a feeler gage of 0.008" to 0.010" (0.20mm to 0.25mm) in between the T slotted guide surfaces of the upper base and the eccentric ball bearing; (see fig. below)</p>  <p>Lock the setscrews, remove the feeler gage and inspect if is with the tolerance across the all surfaces.</p> <p>Repeat if it is necessary.</p>
	<p>Clamping plate does not drop when unclamped due to the improper adjustment of the four clamping bolts</p>	<p>Adjust nylock nuts to set he correct clearance between the bottom side face of the locking T-Slot of the floating base (Riser) and the top part of the clamping plate. They are two on the SG7. The dropping clearance when is on the floating mode should be 0.015" (0.38mm)on all the four corners of the workhead clamping plate</p> <p style="text-align: center;">SG7 MACHINE ADJUSTMENT OF CLAMPING PLATE BETWEEN UPPER MACHINE BASE AND WORKHEAD BASE</p> 

Problem	Possible Cause	Solution
Eccentricity Problems when Cutting Three Angle Seats	Machine is not level	Level machine per instructions in Installation section of this manual
	Workhead is not floating smoothly	Be sure that the work head and main base are clean and floating smoothly side by side and front to back
	Spindle floated to improper center location	Reposition workhead to ensure proper alignment
	Improper setup procedure	The centering switch that is located on the left side of the front panel needs to be on the centering position at the time of centering and machining the valve seat. The Spherical pneumatic switch needs to be on the OFF position and the pilot into the valve guide until reach the proper height or the cutting insert is a few thousands from the valve seat face. Let Workhead flow for few seconds to achieve maximum alignment over the pilot. Be sure there's no contact with the Workhead to allow spindle to stabilize and Cutter to center itself on the valve guide. Release Foot Pedal. Note: Spherical Pneumatic switch should be on the OFF position all the time that you are machining the valve seat; this will give you a positive live centering.
	Toolholder cone dirty	The toolholder cone must be clean before is attached to the spindle and also be sure that the inner spindle cone is clean
	Excessive pressure when cutting seat	Use less pressure when cutting the seat
	Incorrect spindle speed	Adjust spindle speed
	Worn or improperly selected pilot	Check pilot for wear and straightness
	Dull or damaged cutter insert	Replace insert
	Incorrect pilot selection	Follow directions in manual for selecting pilots
Worn tool holder	Check tool holder with bore gauge to determine if there wear	
Worn valve guide	Service valve guides before attempting to cut valve seats	

MACHINE PARTS

Contents

Consumable Parts	8-1
Carbide Inserts	8-2
Special Profiles	8-2
Carbide Pilots	8-2
Bed, Table, and Riser Assembly	8-4
Base Assembly	8-7
Spindle Housing Assembly	8-10
Transmission Assembly New Design	8-14
Head Support and Cradle Assembly.....	8-17
RBHAR1KIT Repair Kit for RBHAR1	8-21
RBHAR40UPCKIT Repair Kit for RBHAR40UPT	8-22
SG100M Pneumatic Drawing	8-23

Consumable Parts

REFERENCE	DESCRIPTION
SLEEVE R1	Spindle adapter replacement sleeve
BSW002	Diamond Wheel Cutting Bit Sharpener replacement Wheel (3.000" Diameter OD by .375" ID)
PRW600PIN	Replaceable Pins for PRW600 Pilot Removable wrench tool
PRW375PIN	Replaceable Pins for PRW375 Pilot Removable wrench tool
PRW20PIN	Replaceable Pins for PRW375 Pilot Removable wrench tool
VT-FP1562	Replacement Foam Pad for Round Vacuum Pad 1.562" diameter
VT-FP1875	Replacement Foam Pad for Round Vacuum Pad 1.875" diameter
VT-FP2125	Replacement Foam Pad for Round Vacuum Pad 2.125" diameter
VT-FP3125	Replacement Foam Pad for Round Vacuum Pad 3.125" diameter
VT-FP25X22	Replacement Foam Pad for Square Vacuum Pad 2.500" x 2.250" square
VT-FP31X20	Replacement Foam Pad for Square Vacuum Pad 3.125" x 2.000" square
VT-FP33X27	Replacement Foam Pad for Square Vacuum Pad 3.375"x 2.750" square
511-29-12F	T7 Torx driver for 1/4" insert (straight angle insert holders only)
511-29-12E	TORX SCREW M2.5 X 0.45 X (straight angle insert holders only)
T8S	T8 Torx Tip Holding Screws
T15S	T15 Torx Tip Holding Screws
MHS-375	Fixed Double Replaceable Insert Milling Head Screws for Large diameter milling Head (3/8" insert)
MHS-250	Fixed Double Replaceable Insert Milling Head Screws for Small diameter milling Head (1/4" insert)
S1032-250	BH375R1 and BH600R1 Tip Holder Looking Screw (10/32" X 1/4") Req. 2
S250-28-250	BH375WR1 Tip Holder Looking Screw 1/4"-28" X 1/4" Req. 2
S1032-437	TH1999 Adjusting Screw (10/32" X 7/16")
S1032-375	TH2000 Adjusting Screw (10/32" X 3/8")
S1032-500	TH2001 Adjusting Screw (10/32" X 1/2")
S1032-625	TH2002 Adjusting Screw (10/32" X 5/8")
S600-1570	TH2003 Adjusting Screw (6.00mm X 15.70mm)
S600-2015	TH2004 Adjusting Screw (6.00mm X 20.15mm)
M10X15X35	SG7 Rollover Fixture Hold down swivel Handle Zinc Handle 35mm (1.375") Long stud (KHF-725)
500-13X2	SG8 Rollover Fixture Hold down swivel Handle Zinc Handle 2.000" Long stud (KHF-162)
500-13X1375	SG7- SG8 Rollover Fixture Lock swivel Handle Zinc Handle 1.375" Long stud (KHF-158)
ICC003	Insert, Indexable carbide, for Fixed milling heads - large size - for 1.562" and larger cutters
ICC002	Insert, Indexable, carbide, for Fixed milling heads - small size - for 1.250" to 1.500" cutters

Carbide Inserts

See Carbide Insert Catalog for a complete list of Insert Profiles available from Rottler Manufacturing.

Special Profiles

Special Profile Cutter Inserts can be manufactured to your exact specifications and can include a combination of angles and radius blends.

There is three different style insert blanks.

A - Style Blank insert, **RCA** is a small insert for all standard applications.

B - Style Blank insert, **RCB** in design for long profiles like High Performances profiles with multi angles o Radius or other special applications

C - Style Blank insert, **RCC** is a much thicker insert for Heavy Duty tooling and can be use for hard seat materials (will work only on the Large Inserts holders series 3000 style insert holders, for the 20.00mm tooling)

Special Order - Special Profile Carbide Cutter Bits are generally considered to be "Customer Proprietary". These are uniquely numbered, exclusively for the ordering customer; prices will vary depending on quantities and additional charge for initial run.

Call us for a quote.

RT312 Insert, triangular positive rake, 3/8 1/32" (.787mm) radius, for the TH3000 series insert holder and RT212 Insert, triangular positive rake, 1/4" (6.35mm) 1/32 " radius for the TH2000 series, for hard seat materials applications (Counterboring and straight angles only)

Carbide Pilots

See Carbide Pilot catalog for a complete list of Pilots available.

Rottler Solid Fixed Carbide Pilots are manufactured from fine grain sintered tungsten carbide and are ground to a very high degree of accuracy, straightness and surface finish - designed for a life time of precision machining!

The part number of the pilot represents the actual diameter in metric of the straight/parallel part of the pilot where the pilot fits into the valve guide.

For example:

UCP0700 means that the diameter of the part of the pilot that goes into the valve guide is 7.00mm (0.2756")

UCP1270 means that the diameter of the part of the pilot that goes into the valve guide is 12.70mm (0.5000")

Pilots are available in increments of .01mm (0.0004"). Normally, a small amount of clearance approx .01mm (0.0004") is required between the pilot and the valve guide.

Most new valve guides are manufactured to a nominal size and the valve stem diameters are manufactured to be smaller than the nominal size to allow clearance for heat expansion of the valve stem when the engine is operating. For example: a 7mm valve guide has an internal diameter of exactly 7.00mm (.2756") The valve stem diameter of the intake valve is 6.98mm (.2748") and the exhaust is 6.96mm (.2740"). In order for the pilot to fit most all valve guides, the first choice could be UCP0699 to give .01mm (0.0004") clearance. If the valve guide is used and has some wear, then the second choice of pilot could be UCP0700(0.2756").

Rottler makes 3 sizes of shanks of pilots:

6.00mm (0.2362") for small valves guides 6mm (0.236") and below. The part number for these pilots is UCPM.

0.375" (9.52mm) for common size valve guides, 6-14mm (.236-.625"). The part number for these pilots is UCP.

20mm (0.7874mm) for large valve guides for SG80A machine. These pilots are made to order specifications.

Bed, Table, and Riser Assembly

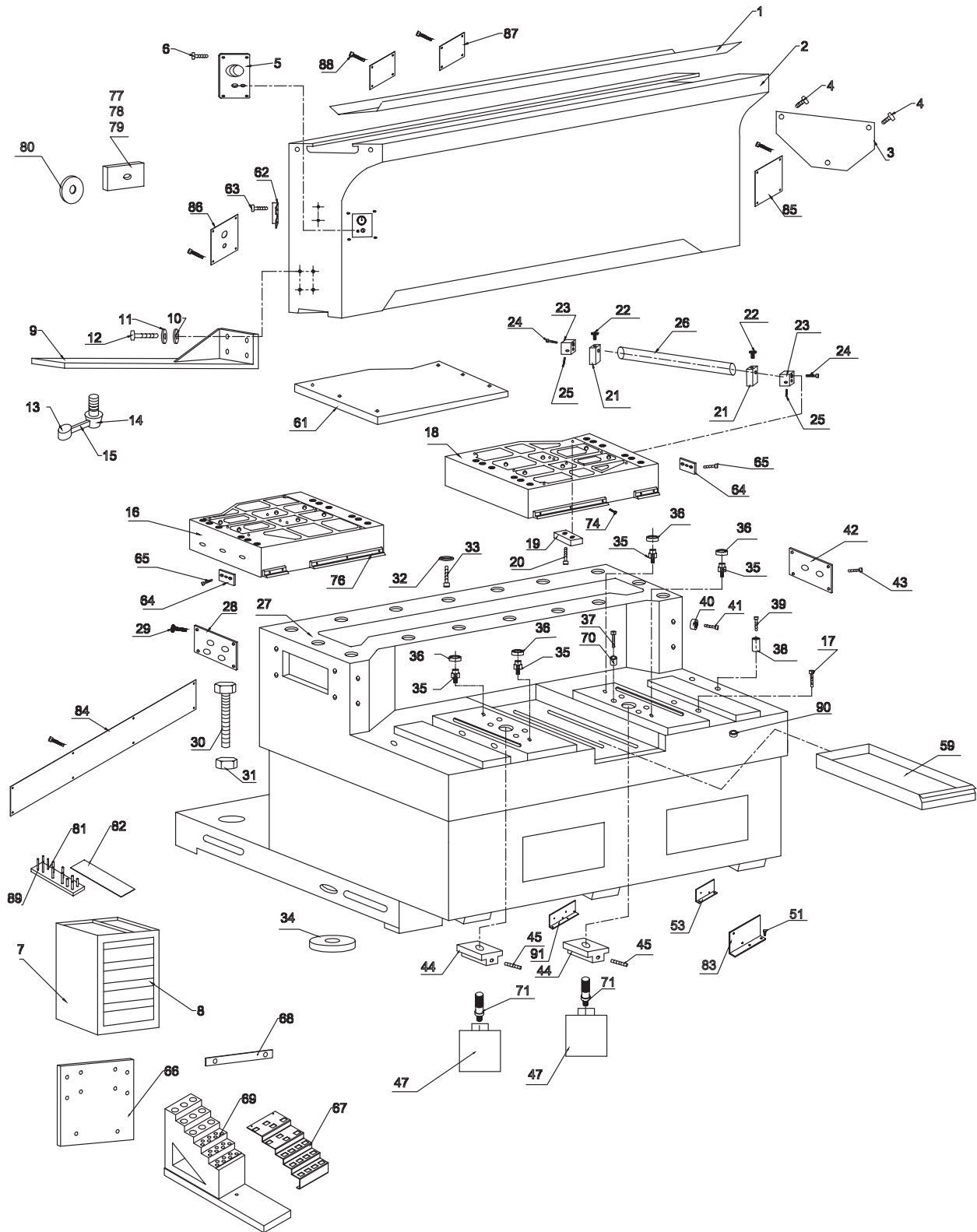

S. NO.	PART NO.	DESCRIPTION	QTY.
			SG-80MTS
1	055A-550	PAN COVER	1
2	055A-500	RISER	1
3	055A-719	END COVER	2
4		ALLEN BUTTON HEAD SCREW M6X12	4
5	055A-546	NAME PLATE	1
6		ALLEN BUTTON HEAD SCREW M6X12	4
7	055A-760	TOOL CABINET	1
8		TOOL TRAY	4
9	430-806	MOUNTING BRACKET	1
10		PLAIN WASHER M8	5
11		LOCK WASHER M8	5
12		HEX. SCREW M8 X 30	4
13	430-802	BALL (M8x25MM O.D.)	1
14	430-817	CLAMP PN	1
15	430-823	CLAMP LEVER	1
16	055A-608	LEFT CROSSTABLE	1
17		ALLEN SCREW M10X20	2
18	055A-607	RIGHT CROSSTABLE	1
19	055A-612	STOPPER	2
20		ALLEN SCREW M6X16	4
21	055A-528	STOP DOG	2
22	055A-551	THUMB SCREW	2
23	055A-529	SUPPORT	2
24		ALLEN SCREW M6X30	2
25		ALLEN GRUB SCREW M5X6	2
26	055A-615	STOPPER ROD	1
27	055A-611	CABINET	1
28	055A-617	NAME PLATE	1
29		ALLEN BUTTON HEAD SCREW M6X12	4
30	430-818	HEX HEAD SCREW M16X70	5
	430-818A	HEX HEAD SCREW M16X180	1
31		HEX NUT M16	6
32		MACHINED WASHER M12	16
33		ALLEN SCREW M12X35	16
34	430-819	PAD	6
35	055A-516	BEARING PIN	4
36		BALL BEARING (60022RS-1)	4
37		ALLEN SCREW M10X55	8
38	055A-613	STOPPER	1
39		ALLEN SCREW M8X35	1
40	055A-602	NYLON STOPPER	2
41		ALLEN SCREW M8X16	2
42	055A-708	NAME PLATE	1
43		ALLEN BUTTON HEAD SCREW M6X12	4
44	055A-515	T-NUT	2
45		ALLEN GRUB SCREW M5X8	2
46	-----	-----	-----
47		PNEUMATIC CYLINDER	2
48	-----	-----	-----
49	-----	-----	-----
50	055A-652	BULKHEAD BRACKET	-----
51		ALLEN HEAD SCREW M6X12	6
52		ALLEN HEAD SCREW M8X16	-----
53	055A-762	BRACKET	1

S. NO.	PART NO.	DESCRIPTION	QTY.
			SG-80MTS
54		FOOT SWITCH	----
55	055A-650	FOOT SWITCH HOUSING	-----
56	-----	-----	-----
57	-----	-----	-----
58	-----	-----	-----
59	055A-709-3	CHIPSTRAY	1
60	-----	-----	-----
61	055A-709-7	CROSSTABLE COVER	2
62	033-069	BRACKET	1
63		ALLEN SCREW M6X12	2
64	055A-664	PLATE	2
65		ALLEN CSK HEAD SCREW M6 X 12	4
66	055A-757	SUPPORTPLATE	1
67	055A-756	STAND	1
68	430-839-4	NAME PLATE	1
69	055A-758	PILOT STAND	1
70	055A-641	CYL. SPACER	8
71	055A-642	CYL. STUD	2
72.	-----	-----	-----
73.	-----	-----	-----
74.		ALLEN HEAD SCREW M5X15	20
75.	055A-712	CONTROL BOX SPACER	-----
76.	055A-697	WIPERS	1 SET
77	101A-109	VACUUM PAD	1
78	101A-110	VACUUM PAD	1
79	101A-111	VACUUM PAD	1
80	101A-112	VACUUM PAD	1
81	055A-759	TOOL BOARD (L.H.) WITH PINS	1
82	055A-755	RUBBER SHEET	1
83	055A-770	BRACKET	1
84	055A-709-2	CABINET COVER	1
85	055A-709-5	RISERCOVER	1
86	055A-709-6	RISERCOVER	1
87	055A-709-1	RISERCOVER	2
88		BUTTON HEAD SCREW M6x10	24
89	055A-766	PIN	4
90	055A-698	STOPPER	2
91	055A-762-1	BRACKET	1

Base Assembly

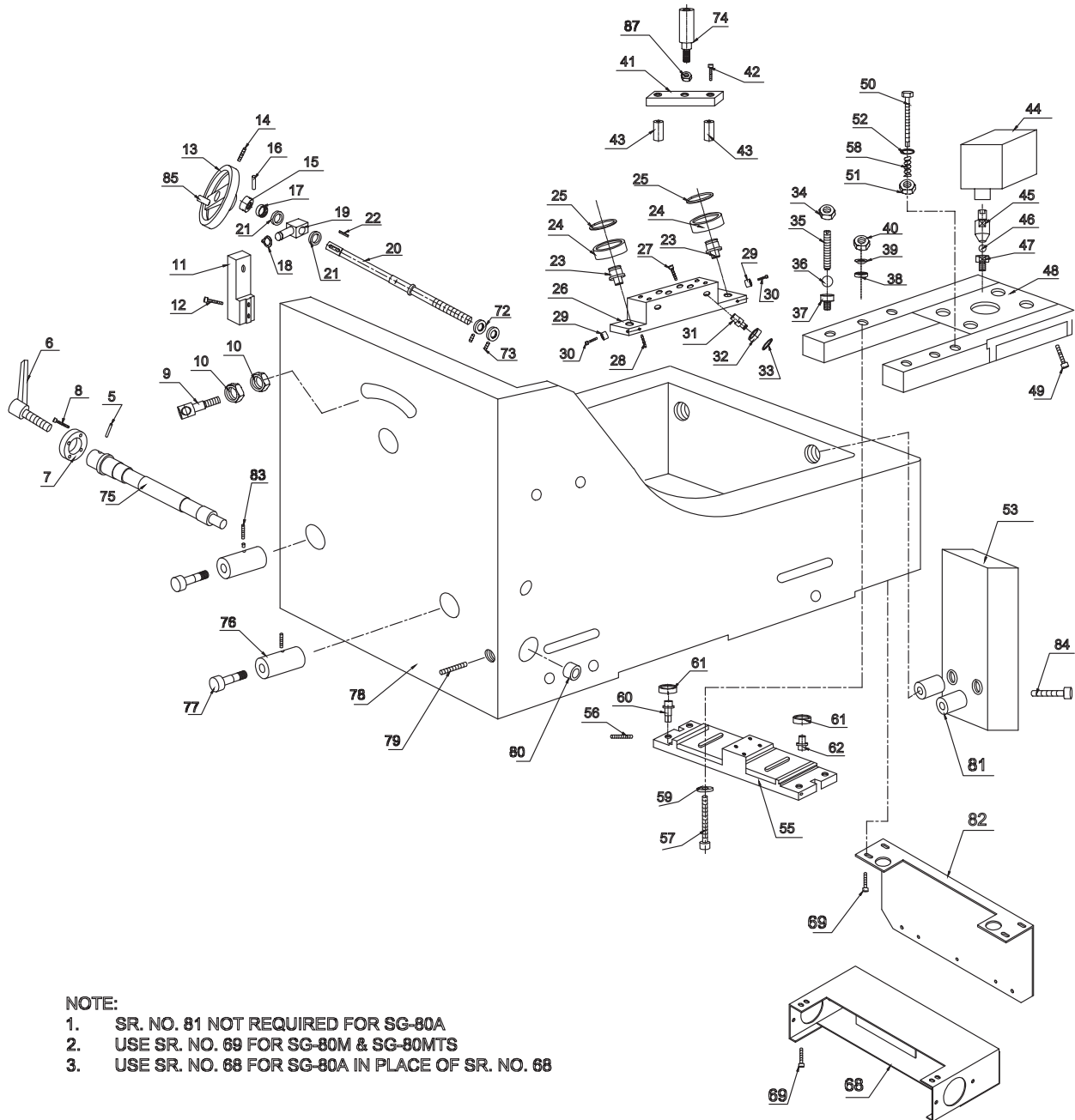

NOTE:

1. SR. NO. 81 NOT REQUIRED FOR SG-80A
2. USE SR. NO. 69 FOR SG-80M & SG-80MTS
3. USE SR. NO. 68 FOR SG-80A IN PLACE OF SR. NO. 68

S. NO.	PART NO.	DESCRIPTION	QTY.
			SG-80MTS
1			
2			
3			
4			
5		CYLINDRICAL PIN DIA. 1/8"X1-1/8" LONG	1
6		ADJUSTABLE HANDLE	1
7	055A-321	SPACER HOUSING	1
8		ALLEN SCREW M6X16	4
9	055A-264	LOCATING BOLT	1
10	055A-320	NUT	2
11	055A-327	SCREW BLOCK	1
12		ALLEN SCREW M8X40	2
13	055A-311	HAND WHEEL	1
14		ALLEN GRUB SCREW M6X10	1
15	055A-309	SPACER	1
16		SPRING DOWEL DIA. 1/8"X1-1/8" LONG	1
17		NEEDLE ROLLER BEARING	1
18		EXT. CIRCLIP A16	1
19	055A-304	GUIDE PIN	1
20	055A-310	INCNCILATION ROD	1
21		NEEDLE THRUST BEARING	2
22		PARALLEL KEY 3/16"X3/16"X7/8"	1
23	055A-502	BEARING PIN	2
24		BALL BEARING (60052RS-1)	2
25		EXT. CIRCLIP A25	2
26	055A-344	CROSS BEARING SUPPORT	1
27		ALLEN SCREW M6X55	4
28		ALLEN GRUB SCREW M5X8	6
29	055A-305	STOPPER	2
30		ALLEN SCREW M5X12	2
31	055A-501	BEARING PIN	4
32		BALL BEARING (6000LLU 12A 01)	4
33		EXT. CIRCLIP A10	4
34		HEX NUT M12	2
35	055A-308	SET SCREW	2
36		STEEL BALL DIA 1/4"	2
37	055A-301	PIVOT	2
38	055A-324	SPHERICAL WASHER	6
39	055A-323	SPHERICAL WASHER	6
40		NYLOCK HEX NUT M12	2
41	055A-316	SWIVEL BRACKET	1
42		ALLEN SCREW M6X55	2
43	055A-315	SPACER	2
44		PNEUMATIC CYLINDER	1
45	055A-306	PIVOT PIN	1
46		STEEL BALL DIA 3/8"	1
47	055A-303	BALL SUPPORT	1
48	055A-322	CLAMPING BRACKET	1
49		ALLEN SCREW M12X30	4
50		HEX HEAD SCREW M8X90	2
51		HEX NUT M8	2
52		WASHER M8	2
53	055A-627	WEIGHT	1
54		ALLEN SCREW M12X75	---

S. NO.	PART NO.	DESCRIPTION	QTY.
			SG-80MTS
55	055A-343	CLAMPING PLATE	1
56		ALLEN GRUB SCREW M5X8	4
57		HEX HEAD SCREW M 12X170	2
58	28250	COMP. SPRING	2
59	055A-325	SPACER	2
60	055A-312	BEARING PIN	2
61		BALL BEARING (60022RS-1)	4
62	055A-313	BEARING PIN	2
63			
64			
65			
66			
67			
68	055A-710	CABLE TRAY WITH COVER	---
69		ALLEN SCREW M6X12	---
70	-----	-----	---
71	-----	-----	---
72	055A-342	STOP COLLAR	2
73		ALLEN SET SCREW M6X2	2
74	055A-341	TIE ROD SUPPORT	1
75	055A-334	ECCENTRIC SHAFT	1
76	055A-336	CLAMPING BLOCK	2
77	055A-339	CLAMPING BOLT	2
78	055A-333	BASE	1
79		GRUB SCREW (M 6x16)	2
80	055A-345	ECCENTRIC BUSH	1
81	055A-629	WEIGHT SPACER (M)	2
82	055A-346	CONDUIT PLATE (M)	1
83		ALLEN HEAD GRUB SCREW M6x10	2
84		ALLEN HEAD CAP SCREW M12x100	2
85	430-637R	KNOB	1
86	430-638-R	PLUG (LEVER)	1
87		HEX. NUT M12	1

Spindle Housing Assembly

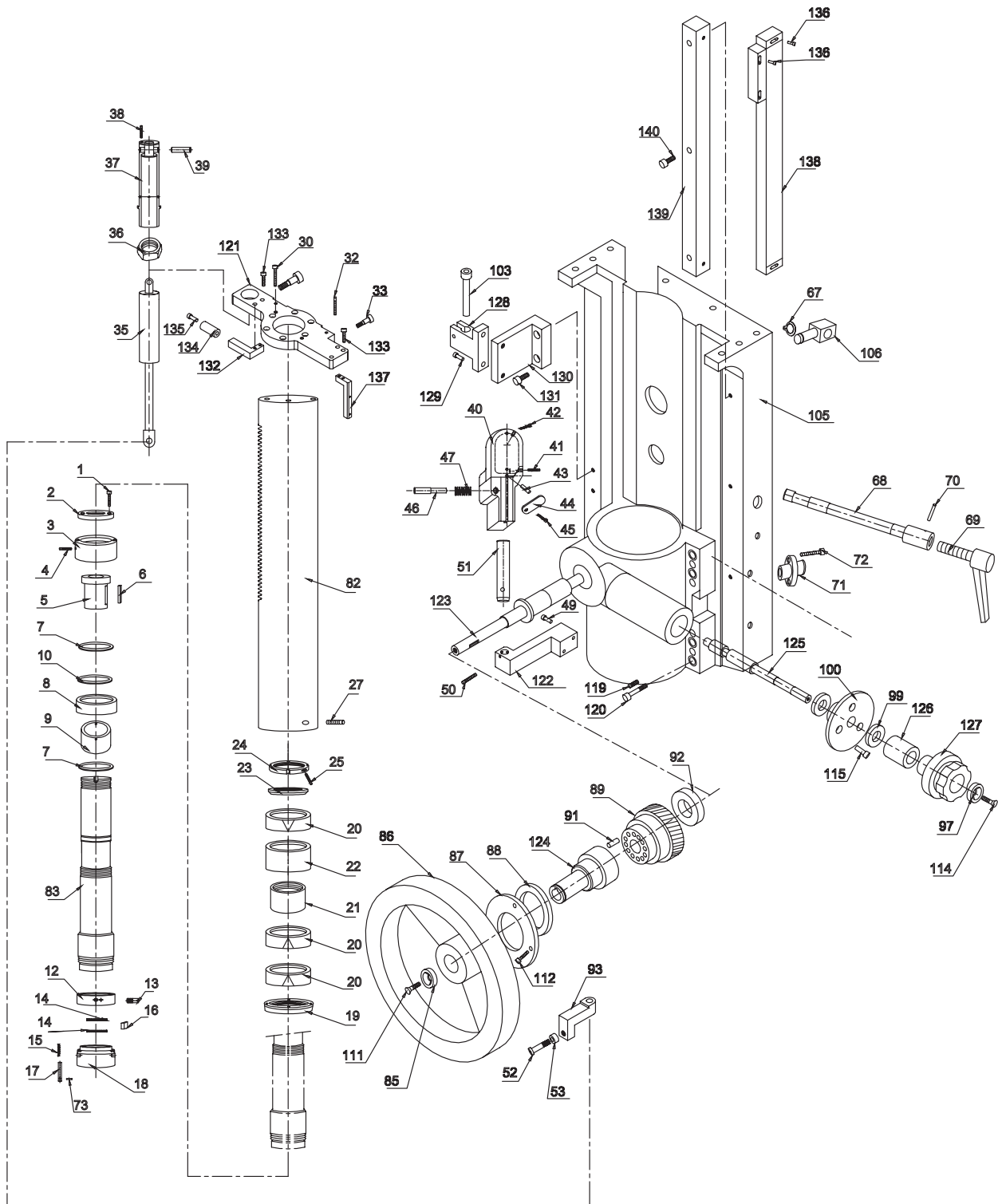

S. NO.	PART NO.	DESCRIPTION	QTY.
			SG-80MTS
1		ALLEN SCREW M5X12	2
2	055A-103	BRASS STOPPER	1
3	055A-105	NUT	1
4		ALLEN GRUB SCREW M5X8	1
5	055A-404	SPLINE BUSH	1
6		PARALLEL KEY 1/4"X1/4"X1-1/2"	1
7		EXT. CIRCLIP A48	2
8		NEEDLE ROLLER BEARING	1
9	055A-122	BEARING SUPPORT	1
10		EXT. CIRCLIP A55	1
11			
12	KS-09-06	COVER	1
13	KS-08-01	STOP PIN	1
14	KS-09-03	COMP. SPRING	2
15	KS-08-04	COMP. SPRING	1
16	KS-08-02	PAD	1
17	KS-08-05	PIN	1
18	KS-09-07	NUT	1
19	055A-102	QUILL NUT	1
20		ANGULAR CONTACT BALL BEARING	3
21	055A-124	SPACER	1
22	055A-123	SPACER	1
23	055A-107	SPINDLE SPACER	1
24	055A-106	SPINDLE NUT	1
25		ALLEN GRUB SCREW M5X8	2
26	055A-189	QUILL	---
27		ALLEN GRUB SCREW M5X8	2
28	055A-190	STOP PLATE	---
29		ALLEN SCREW M6X16	---
30		ALLEN SCREW M6X25	6
31		ALLEN SCREW M8X20	---
32		ALLEN GRUB SCREW M5X6	2
33	055A-121	ADJUSTING SCREW	2
34	055A-126	STOP DOG	---
35		COMP. GAS SPRING	1
36	055A-104	NUT	1
37	055A-111	GAS SPRING SUPPORT	1
38		ALLEN GRUB SCREW M4X6	1
39	055A-113	CYL. PIN	1
40	055A-236	LEVEL BLOCK	1
41		ALLEN GRUB SCREW M6X6	1
42		ALLEN SCREW 6-32X5/8" LONG	2
43		CYL. PIN DIA 3/16"X1-1/8" LONG	1
44	055A-237	CLAMP	1
45		ALLEN SCREW M5X12	1
46	055A-238	CLAMP PIN	1
47	055A-240	SPRING	1
48	----	----	-----
49		ALLEN SCREW M8X65	2
50		ALLEN GRUB SCREW M6X12	3
51	055A-239	CLAMP	1
52	055A-247	GAS SPRING SCREW	1
53	055A-248	GAS SPRING SPACER	1
54	055A-295	GAS SPRING HOLDER	---

S. NO.	PART NO.	DESCRIPTION	QTY.
			SG-80MTS
55			
56			
57			
58			
59			
60			
61			
62		ALLEN CAP SCREW M6x30	---
63			
64			
65	055A-297	SPINDLE HOUSNG	---
66			---
67		EXT. CIRCLIP A16	1
68	055A-268	ECCENTRIC CLAMP	1
69		ADJUSTABLE HANDLE	1
70		CYL. PIN DIA 1/8"X1-1/8" LONG	1
71	055A-219	PIVOT PIN	1
72		ALLEN SCREW M6X12	4
73		PIN DIA 0.093"X0.350" LONG	1
74			
75			
76			
77	055A-337	LUB. FEEDER	---
78		ALLEN HEAD SCREW M6x30	---
79		OILER	---
80	055A-127	STOP PLATE (M)	---
81	055A-877	DIAL BK T. (M)	---
82	055A-100	QUILL (M)	1
83	055A-171	SPINDLE	1
84	055A-776	PINION SHAFT(M)	---
85	055A-781	END SPACER(M)	1
86	055A-780	HAND WHEEL (M)	1
87	055A-783	GEAR END SPACER(M)	1
88	055A-782	GEAR SPACER(M)	1
89	055A-778	HELICAL GEAR(M)	1
90	055A-779	BUSH(M)	---
91	055A-785	CYL. PIN(M)	2
92	055A-761	SPACER (M)	1
93	055A-284	GAS SPRING HØDER (M)	1
94	055A-289	INDICATED MTG. BKT. (M)	---
95	055A-287	INDICATED MTG. ROD (M)	---
96	055A-290	CLAMP (M)	---
97	055A-210	SPACER	1
98	055A-226	FEED DIAL (M)	---
99		THRUST BEARING (51102)	2
100	055A-291	BRG. HOUSING(M)	1
101	055A-784	WORM(M)	---
102	430-606-S	STOP ROD BLOC	---
103	055A-288	CONTROL STOP SCREW (M) WTH KNOB	1
104	-----	-----	---
105	055A-263	SPINDLE HOUSNG (M)	1
106	055A-270	NUT(M)	1
107	055A-722	PANEL BOX(M)	---
108	055A-723	MTG. BKT.(M)	---

S. NO.	PART NO.	DESCRIPTION	QTY.
			SG-80MTS
109		ALLEN GRUB SCREW M6x15	---
110		ALLEN GRUB SCREW M6x20	---
111		ALLEN HEAD CSK SCREW M8x \emptyset	1
112		ALLEN HEAD CAP SCREW M5x12	3
113		ALLEN HEAD CAP SCREW M6x15	---
114		ALLEN HEAD CSK SCREW M6x \emptyset	1
115		ALLEN HEAD CAP SCREW M6x12	3
116		ALLEN HEAD CSK SCREW M6x \emptyset	---
117		ALLEN HEAD CAP SCREW M8x12	---
118		ALLEN HEAD CAP SCREW M8x20	---
119		ALLEN GRUB SCREW M10x25	4
120		ALLEN HEAD CAP SCREW M10x35	4
121	055A-131	STOP PLATE	1
122	055A-282	LEVEL SUPPORT	1
123	055A-280	PINION SHAFT	1
124	055A-281	BUSH	1
125	055A-277	WORM	1
126	055A-278	WORM SHAFT	1
127	055A-279	FEED DIAL	1
128	055A-274	LATCH STOP	1
129		ALLEN HEAD CAP SCREW M6x16	2
130	055A-273	LATCH SUPPORT	1
131		ALLEN HEAD CAP SCREW M6x20	2
132	055A-275	STOPPER	1
133		ALLEN HEAD CAP SCREW M6x30	4
134	055A-276	STOPPER EXTN.	1
135		ALLEN HEAD CAP SCREW M8x45	1
136		ALLEN HEAD CAP SCREW M4x20	1
137	055A-272	HEAD SUPPORT	1
138		OPTICAL SCALE	1
139	055A-271	SCALE SUPPORT	1
140		ALLEN HEAD CAP SCREW M6x30	3

Transmission Assembly New Design

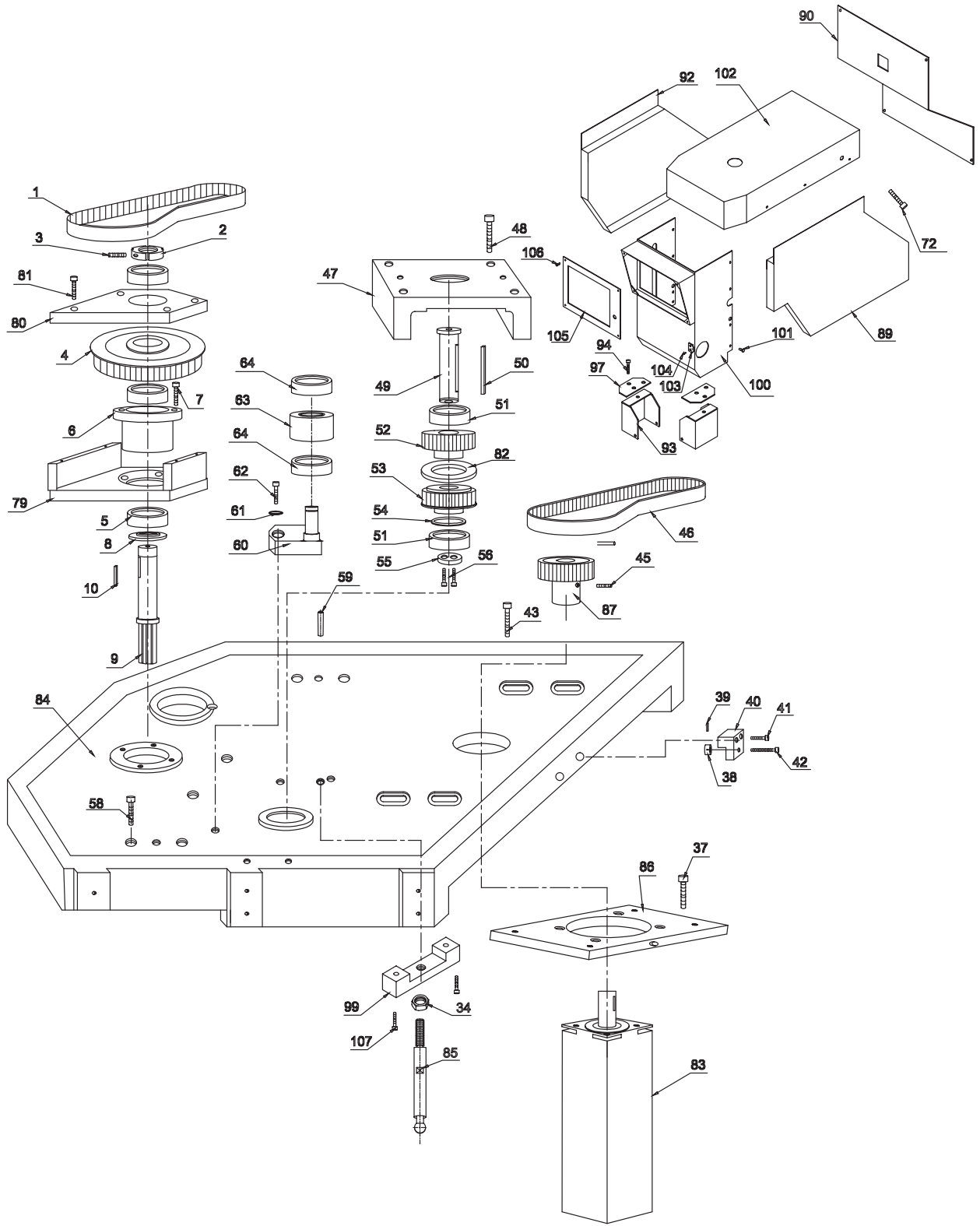

S. NO.	PART NO.	DESCRIPTION	QTY.
			SG-80MTS
1		SPINDLE POLYCHAIN BELT	
2	055A-406	SHAFT NUT	1
3		ALLEN GRUB SCREW M5X8	1
4	055A-447	SPINDLE PULLEY	1
5		BALL BEARING 30x62x162RS	3
6	055A-449	BEARING HOUSING	1
7		ALLEN SCREW M8X25	4
8	055A-429	BEARING SPACER	1
9	055A-472	DRIVE SHAFT	1
10		PARALLEL KEY 5/16"X5/16"X1-1/4"	1
11	055A-255	TOP PLATE	---
12	055A-422	RING NUT	---
13		ALLEN GRUB SCREW M5X6	1
14	055A-430	BEARING SPACER	---
15	055A-442	BEARING COVER	---
16		ALLEN SCREW M6X12	---
17	055A-441	BEARING HOUSING	---
18		ALLEN SCREW M6X16	---
19		ANGULAR CONTACT BALL BRG. (7204)	---
20	055A-443	BEARING SPACER	---
21		ALLEN GRUB SCREW M5x8	
22	055A-427	PULLEY	---
23	055A-480	BALL SCREW	---
24		PARALLEL KEY 1/4"X1/4"X1-5/16"	---
25		EXT. CIRCLIP A12	---
26	055A-479	BEARING HOUSING	---
27		ALLEN SCREW M5X12	---
28		Z-AXIS MOTOR	---
29	055A-405	MOTOR SUPPORT	---
30		ALLEN SCREW M6X20	---
31	055A-409	MOTOR PULLEY	---
32		ALLEN GRUB SCREW M5X8	---
33	-----	-----	---
34		HEX NUT M12	1
35		SPINDLE MOTOR	---
36	055A-407	MOTOR PLATE	---
37		ALLEN SCREW M10X27	4
38	055A-254	SPACER	1
39		CYLINDRICAL PIN DIA 1/8"X5/8" LONG	1
40	055A-253	ADJUSTING BLOCK	1
41		ALLEN SCREW M6X30	1
42		ALLEN SCREW M8X50	1
43		ALLEN SCREW M10X30	4
44	055A-438	MOTOR PULLEY	---
45		ALLEN GRUB SCREW M6X10	1
46		MOTOR POLY CHAIN BELT	1
47	055A-256	BEARING SUPPORT	1
48		ALLEN SCREW M10X75	4
49	055A-440	INT. SHAFT	1
50		PARALLEL KEY 5/16"X5/16"X3"	1
51		BALL BEARING(6206)	2
52	055A-448	UPPER INT. PULLEY	1
53	055A-439	LOWER INT. PULLEY	1
54		INT. CIRCLIP B 62	1

S. NO.	PART NO.	DESCRIPTION	QTY.
			SG-80MTS
55	055A-435	BEARING SPACER	1
56		ALLEN SCREW M6X15	2
57		ALLEN SCREW M6X20	---
58		ALLEN SCREW M10X30	4
59		CYL. PIN	2
60	055A-478	IDLER SUPPORT	1
61		EXT. CIRCLIP A20	1
62		ALLEN SCREW M12X35	1
63	055A-436	IDLER PULLEY	1
64		BALL BEARING (6004 LLU/2AS)	2
65		BALL BEARING (6904-2RS) 20 x 37 x 9	---
66		TIMING BELT	---
67	055A-700	TOP COVER	---
68	055A-789	RIGHT COVER	---
69	055A-790	LEFT COVER	---
70	055A-703	BACK COVER	---
71	055A-791	FRONT COVER	---
72		ALLEN BUTTON SCREW M5X6	26
73	055A-283	BLOCK	---
74		ALLEN SCREW M8X25	---
75		ALLEN SCREW M8X35	---
76	055A-446	BALL SCREW BRACKET	---
77		ALLEN SCREW M5X16	---
78	-----	-----	---
79	055A-474	BEARING SUPPORT	1
80	055A-475	BEARING COVER	1
81		ALLEN HEAD CAP SCREW M8x20	4
82	055A-335	PULLEY SPACER	1
83	-----	SPINDLE MOTOR	1
84	055A-227	TOP PLATE (M)	1
85	055A-340	PLATE SUPPORT	1
86	055A-476	MOTOR PLATE(M)	1
87	055A-477	MOTOR PULLEY(M)	1
88	055A-720	FRONT COVER(M)	---
89	055A-751	RIGHT COVER(M)	1
90	055A-753	BACK COVER(M)	1
91	055A-725	TOP COVER(M)	1
92	055A-752	LEFT COVER(M)	1
93	055A-713	LIGHT BRACKET	2
94		ALLEN HEAD SCREW M6x10	4
95	055A-714	DUST COVER	---
96		ALLEN HEAD SCREW M6x10	---
97	055A-749	LIGHT BRACKET	2
98	055A-220	SUPPORTPLATE	---
99	055A-221	SUPPORTPLATE (M)	1
100	055A-763	FRONT COVER	1
101		ALLEN BUTTON HEAD SCREW M6x10	16
102	055A-765	TOP COVER	1
103	055A-768	ZERO MARK	1
104		ALLEN BUTTON HEAD SCREW M4x6	2
105	055A-764	PANEL PLATE	1
106		ALLEN BUTTON HEAD SCREW M6x10	4
107		ALLEN HEAD SCREW M 6x30	2

Head Support and Cradle Assembly

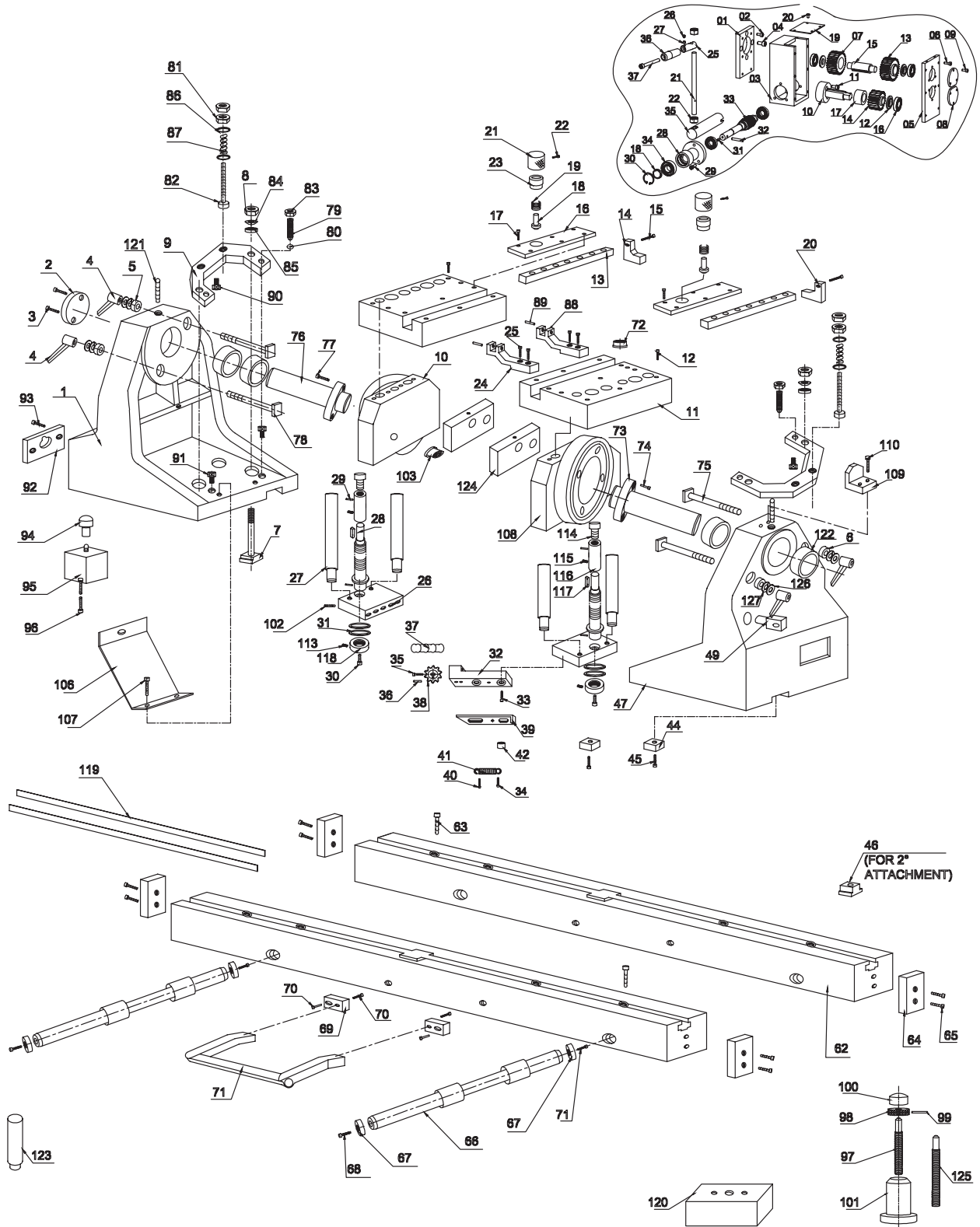

S. NO.	PART NO.	DESCRIPTION	QTY. SG-80MTS
1	055A-678	CRADLE LEFT	1
2	055A-662	SPACER	1
3		ALLEN HEAD SCR EW M6X12	2
4		ADJUSTABLE HANDLE	4
5	055A-663	SPACER	2
6	055A-660	SPACER	2
7	055A-676	T-BOLT	4
8		NYLOCK HEX NUT M12	4
9	055A-671	CLAMPING BRACKET	2
10	055A-657	CRADLE HOLDER (LEFT)	1
11	055A-573	SUPPORTPLATE	2
12		ALLEN SCREW M10X35	8
13	430-940	FLAT	2
14	430-937	STOP PLATE (L. H)	1
15		ALLEN SCREW M6 X 20	2
16	055A-527	COVERPLATE	2
17		ALLEN CSK SCREW M5X12	12
18	430-919	PLUNGER	2
19	430-921	SPRING (NO. 10057)	2
20	430-935	STOP PLATE (R.H)	1
21	430-918	KNURLING COLLAR	2
22		ALLEN SCREW M6 X 6	2
23	430-916	PIN HOLDER	2
24	055A-569	CHAIN BLOCK-A	2
25		ALLEN SCREW M10X25	8
26	055A-579	CLAMP PLATE	2
27	055A-588	GUIDE ROD	4
28	055A-638	SCREW RØ	2
29		CYLINDRICAL PIN DIA. 4 x 20 LONG	2
30		ALLEN HEAD SCREW M12 x 25	2
31		NEEDLE THRUST BEARING 20 x 34 x 4	4
32	055A-576	SPROCKETSUPPORT	4
33		ALLEN HEAD SCREW M10X20	8
34		ALLEN BUTTON HEAD SCREW M5X10	12
35		ALLEN SCREW M8X20	4
36		DOWEL PIN DIA 1/8"X58" LONG	4
37		ROLLER CHAIN	1
38	055A-556	SPROCKET	4
39	055A-564	TOP PLATE	4
40		ALLEN BUTTON HEAD SCREW M5X6	4
41	055A-557	TENSION SPRING	4
42	055A-565	BUSH	12
43			
44	055A-623	TENON	4
45		ALLEN SCREW M5X12	4
46	055A-619	T-NUT	4
47	055A-679	CRADLE RIGHT	1
48			
49			
50			
51			
52			
53			

S. NO.	PART NO.	DESCRIPTION	QTY. SG-80MTS
54			
55			
56			
57			
58			
59			
60			
61			
62	055A-654	PARALLEL BAR	2
63		ALLEN SCREW M12X55	8
64	055A-590	END STOPPER	4
65		ALLEN SCREW M6X12	8
66	055A-675	GUIDE ROD	2
67	055A-560	END COVER	4
68		ALLEN SCREW M8X20	2
69	055A-595	HANDLE BLOCK	2
70		ALLEN SCREW M8X16	4
71		ALLEN SCREW M8X25	2
72	055A-626	PLUG	4
73	055A-658	HOLDER SHAFT RIGHT	1
74		ALLEN SCREW M10X20	4
75	055A-670	T-BOLT	2
76	055A-659	HOLDER SHAFT LEFT	1
77		ALLEN SCREW M10X20	4
78	055A-669	T-BOLT	2
79	055A-674	SET-SCREW	4
80		STEEL BALL DIA 6MM	4
81		NYLOCK NUT M8	4
82		ALLEN HEAD SCREW M8X90	4
83		HEX NUT M12	2
84	055A-323	SPHERICAL WASHER	4
85	055A-324	SPHERICAL WASHER	4
86		WASHER M8	8
87	282580	COMP. SPRING	4
88	055A-625	CHAIN BLOCK-B	2
89	055A-567	PIN	12
90	055A-635	PIVOT	2
91	055A-672	PIVOT	4
92	055A-645	VALVE PLATE	2
93		ALLEN CSK SCREW M6X12	4
94	055A-673	CYLINDER EXTENSION	2
95		PNEUMATIC CYLINDER	2
96		ALLEN HEAD SCREW M6X70	8
97	055A-682	JACK SCREW	1
98	055A-683	JACK COLLAR	2
99		CYLINDRICAL PIN DIA 1/8"X1-1/2" LONG	1
100	055A-681	JACK TOP	1
101	055A-680	JACK BASE	1
102		ALLEN GRUB SCREW M6X6	4
103	055A-661	PLUG	2
104			
105			
106	055A-718	CRADLE COVER	2
107		ALLEN BUTTON HEAD SCREW M5X10	6

S. NO.	PART NO.	DESCRIPTION	QTY. SG-80MTS
108	055A-694	CRADLE HOLDER (RIGHT)	1
109	055A-695	ZERO MARK	1
110		ALLEN HEAD CAP SCREW M6X16	2
111			
112			
113		ALLEN GRUB SCREW M5x6	2
114		ALLEN HEAD SCREW M12x16	2
115		ALLEN GRUB SCREW M 6x6	2
116	055A-639	SHAFT EXTENSION	2
117		PARALLEL KEY 3/16"x3/16"x1/2	2
118	055A-640	RING NUT	2
119	055A-654-S	PARALLEL BAR SCALE	1 SET
120	055A-606	HEIGHT BLOCK	2
121	055A-668	SET SCREW	2
122		NEEDLE BEARING NK 40/20	4
123	055A-646	CLAMPING PIN	4
124	055A-648	CLAMP PLATE	2
125	055A-684	JACK SCREW LARGE	1
126		WASHER M12	4
127		SPRING WASHERM12	4

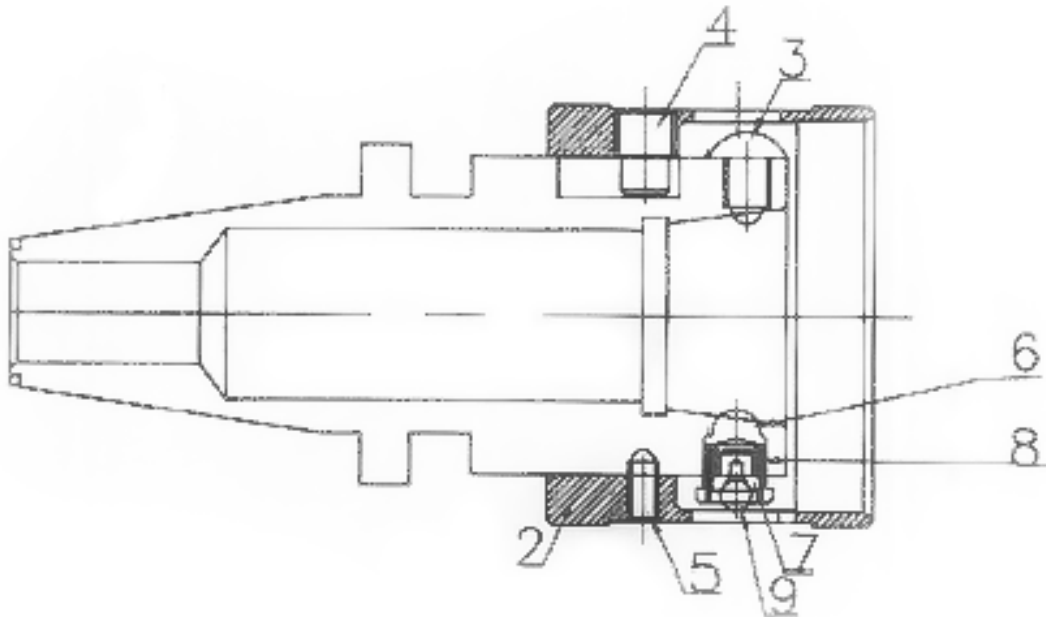
RBHAR1KIT Repair Kit for RBHAR1

Item	Part #	Description	Quantity
2	RBHAR1COL	Collar	1
3	555-19-19	Stop Screw	2
4	555-19-20	Dog Point Screw	2
5	555-19-21	Ball Point	2
6	555-19-22	Detent	4
7	555-19-23	Ball Seat	4
8	555-19-24	Spring	4
9	555-19-25	Ball (4mm)	4

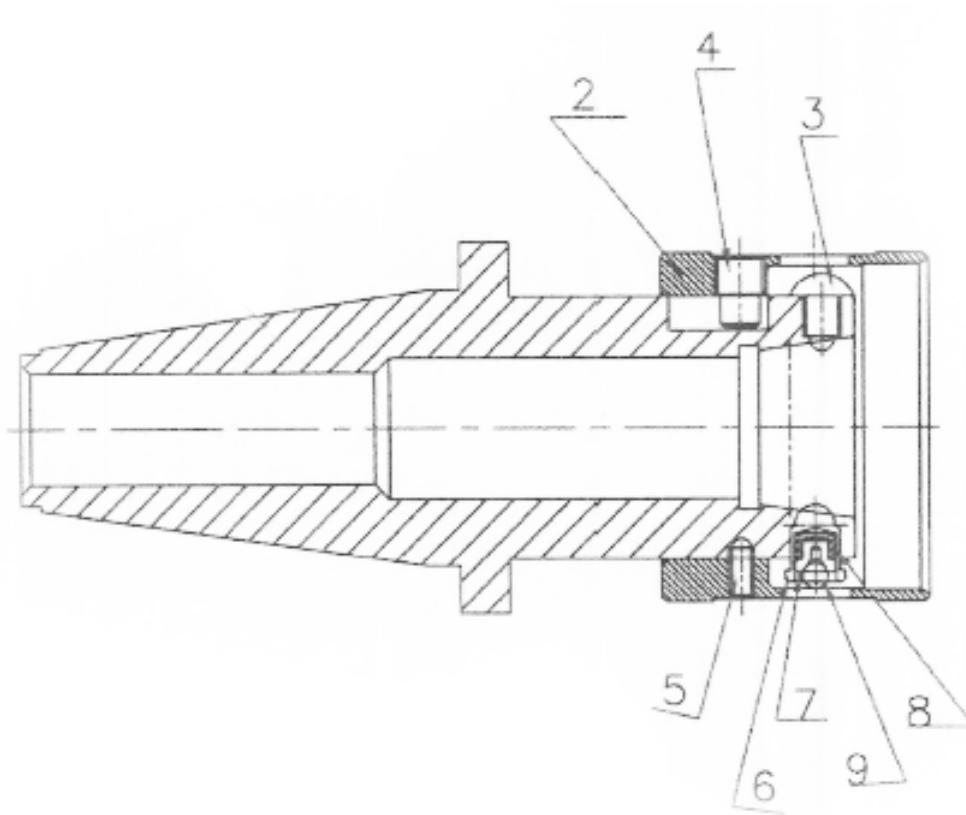
RBHAR40UPCKIT Repair Kit for RBHAR40UPT

Item	Part #	Description	Quantity
2	RBHAR40UPCCOL	Collar	1
3	555-19-19	Stop Screw	2
4	555-19-20	Dog Point Screw	2
5	555-19-21	Ball Point	2
6	555-19-22	Detent	4
7	555-19-23	Ball Seat	4
8	555-19-24	Spring	4
9	555-19-25	Ball (4mm)	4

SG100M Pneumatic Drawing

**SG-80A & SG-80MTS
PNEUMATIC CIRCUIT DIAGRAM**

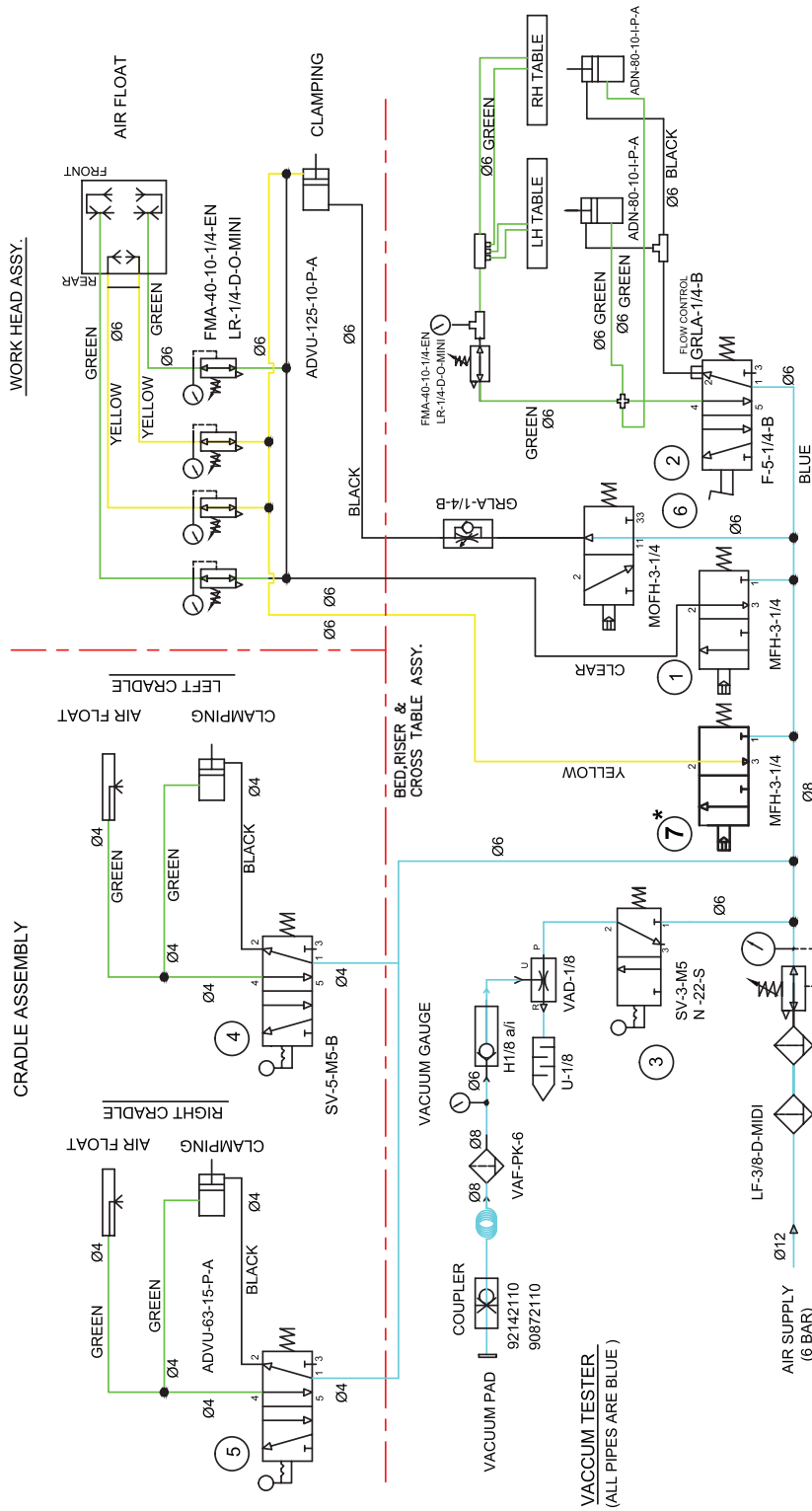

CROSS TABLES

- NOTE:
- ① SOLENOID VALVE FOR WORK HEAD AIR FLOAT "ON" & "OFF" (SG-80A & SG-80MTS) FRONT PORT.
 - ② SOLENOID VALVE FOR CROSS TABLE AIR FLOAT & CLAMP
 - ③ SELECTOR SWITCH FOR VACUUM TESTER
 - ④ SELECTOR SWITCH FOR LEFT CRADLE AIR FLOAT & CLAMP
 - ⑤ SELECTOR SWITCH FOR RIGHT CRADLE AIR FLOAT & CLAMP
 - ⑥ SOLENOID VALVE FOR WORK HEAD CLAMP & DECLAMP (SG-80A)
 - * ⑦ SOLENOID VALVE FOR WORK HEAD AIR FLOAT "ON" & "OFF" REAR PORT.

OPTIONS

Optional Equipment

Optional Equipment Catalog and Parts Manual are located at the Rottler Manufacturing web site.
www.rottlermfg.com

This page intentionally left blank

SDS

The Safety Data Sheets list shown in this section are the substances and materials that an operator is most likely to come in contact with while using this machine.

Other substances and materials are used in the manufacture, testing, and shipping of this machine. A complete list of the Safety Data Sheets of substances and materials used by Rottler Manufacturing during manufacturing, testing, and shipping is located on the Manual flash drive shipped with the machine. Safety Data Sheets are also located on the company web site: <http://www.rottlermfg.com/documentation.php>

1) Way Oil

2) Multi-Purpose EP Grease

Safety Data Sheet

According to OSHA HCS 2012 (29 CFR 1910.1200), Health Canada HPR (SOR/2015-17), and Mexico NOM-018-STPS-2015



SECTION 1: Identification

Product Identifier **Multi-Way Oil HD**
Other means of identification Phillips 66 Multi-Way Oil HD 32
 Phillips 66 Multi-Way Oil HD 68
 Phillips 66 Multi-Way Oil HD 220
Code **LBPH817776**
Relevant identified uses Way Oil
Uses advised against All others
24 Hour Emergency Phone Number CHEMTREC: 1-800-424-9300
 CHEMTREC México 01-800-681-9531

Manufacturer/Supplier
 Phillips 66 Lubricants
 P.O. Box 4428
 Houston, TX 77210

SDS Information
 URL: www.phillips66.com/SDS
 Phone: 800-762-0942
 Email: SDS@P66.com

Customer Service
 U.S.: 800-368-7128 or International: 1-832-765-2500
Technical Information
 1-877-445-9198

SECTION 2: Hazard identification

Classified Hazards

No classified hazards

Hazards Not Otherwise Classified (HNOC)

PHNOC: None known

HHNOC: None known

Label elements

No classified hazards

SECTION 3: Composition/information on ingredients

Chemical Name	CASRN	Concentration
Distillates, petroleum, hydrotreated heavy paraffinic	64742-54-7	>40
Distillates, petroleum, solvent-dewaxed heavy paraffinic	64742-65-0	>45
Residual oils, petroleum, solvent-dewaxed	64742-62-7	>10

* All concentrations are percent by weight unless ingredient is a gas. Gas concentrations are in percent by volume.

SECTION 4: First aid measures

Eye Contact: If irritation or redness develops from exposure, flush eyes with clean water. If symptoms persist, seek medical attention.

Skin Contact: Remove contaminated shoes and clothing and cleanse affected area(s) thoroughly by washing with mild soap and water or a waterless hand cleaner. If irritation or redness develops and persists, seek medical attention.

LBPH817776 - Multi-Way Oil HD
 Issue Date: 16-Apr-2018

Page 1/6
 Status: FINAL

LBPH817776 - Multi-Way Oil HD
Issue Date: 16-Apr-2018

Page 2/6
Status: FINAL

Inhalation: First aid is not normally required. If breathing difficulties develop, move victim away from source of exposure and into fresh air in a position comfortable for breathing. Seek immediate medical attention.

Ingestion: First aid is not normally required; however, if swallowed and symptoms develop, seek medical attention.

Most important symptoms and effects, both acute and delayed: Inhalation of oil mists or vapors generated at elevated temperatures may cause respiratory irritation. Accidental ingestion can result in minor irritation of the digestive tract, nausea and diarrhea. Prolonged or repeated contact may dry skin and cause irritation.

Notes to Physician: Acute aspirations of large amounts of oil-laden material may produce a serious aspiration pneumonia. Patients who aspirate these oils should be followed for the development of long-term sequelae. Inhalation exposure to oil mists below current workplace exposure limits is unlikely to cause pulmonary abnormalities.

SECTION 5: Firefighting measures

NFPA 704: National Fire Protection Association

Health: 0 **Flammability:** 1 **Instability:** 0



0 = minimal hazard
 1 = slight hazard
 2 = moderate hazard
 3 = severe hazard
 4 = extreme hazard

Extinguishing Media: Dry chemical, carbon dioxide, foam, or water spray is recommended. Water or foam may cause frothing of materials heated above 212°F / 100°C. Carbon dioxide can displace oxygen. Use caution when applying carbon dioxide in confined spaces. Simultaneous use of foam and water on the same surface is to be avoided as water destroys the foam.

Specific hazards arising from the chemical

Unusual Fire & Explosion Hazards: This material may burn, but will not ignite readily. If container is not properly cooled, it can rupture in the heat of a fire.

Hazardous Combustion Products: Combustion may yield smoke, carbon monoxide, and other products of incomplete combustion. Oxides of sulfur, nitrogen or phosphorus may also be formed.

Special protective actions for fire-fighters: For fires beyond the initial stage, emergency responders in the immediate hazard area should wear protective clothing. When the potential chemical hazard is unknown, in enclosed or confined spaces, a self contained breathing apparatus should be worn. In addition, wear other appropriate protective equipment as conditions warrant (see Section 8). Isolate the hazard area and deny entry to unnecessary and unprotected personnel. Stop spill/release if it can be done safely. Move undamaged containers from immediate hazard area if it can be done safely. Water spray may be useful in minimizing or dispersing vapors and to protect personnel. Cool equipment exposed to fire with water, if it can be done safely. Avoid spreading burning liquid with water used for cooling purposes.

See Section 9 for Flammable Properties including Flash Point and Flammable (Explosive) Limits

SECTION 6: Accidental release measures

Personal precautions, protective equipment and emergency procedures: This material may burn, but will not ignite readily. Keep all sources of ignition away from spill/release. Stay upwind and away from spill/release. Avoid direct contact with material. For large spillages, notify persons down wind of the spill/release, isolate immediate hazard area and keep unauthorized personnel out. Wear appropriate protective equipment, including respiratory protection, as conditions warrant (see Section 8). See Sections 2 and 7 for additional information on hazards and precautionary measures.

Environmental Precautions: Stop and contain spill/release if it can be done safely. Prevent spilled material from entering sewers, storm drains, other unauthorized drainage systems, and natural waterways. Use water sparingly to minimize environmental contamination and reduce disposal requirements. If spill occurs on water notify appropriate authorities and advise shipping of any hazard. Spills into or upon navigable waters, the contiguous zone, or adjoining shorelines that cause a sheen or discoloration on the surface of the water, may require notification of the National Response Center (phone number 800-424-8802).

Methods and material for containment and cleaning up: Notify relevant authorities in accordance with all applicable regulations. Immediate cleanup of any spill is recommended. Dike far ahead of spill for later recovery or disposal. Absorb spill with

LBPH817776 - Multi-Way Oil HD
Issue Date: 16-Apr-2018

Page 3/6
Status: FINAL

inert material such as sand or vermiculite, and place in suitable container for disposal. If spilled on water remove with appropriate methods (e.g. skimming, booms or absorbents). In case of soil contamination, remove contaminated soil for remediation or disposal, in accordance with local regulations.

Recommended measures are based on the most likely spillage scenarios for this material; however local conditions and regulations may influence or limit the choice of appropriate actions to be taken. See Section 13 for information on appropriate disposal.

SECTION 7: Handling and storage

Precautions for safe handling: Keep away from flames and hot surfaces. Wash thoroughly after handling. Use good personal hygiene practices and wear appropriate personal protective equipment (see section 8). Spills will produce very slippery surfaces. Do not enter confined spaces such as tanks or pits without following proper entry procedures such as ASTM D-4276 and 29CFR 1910.146. Do not wear contaminated clothing or shoes.

Conditions for safe storage: Keep container(s) tightly closed and properly labeled. Use and store this material in cool, dry, well-ventilated area away from heat and all sources of ignition. Store only in approved containers. Keep away from any incompatible material (see Section 10). Protect container(s) against physical damage.

"Empty" containers retain residue and may be dangerous. Do not pressurize, cut, weld, braze, solder, drill, grind, or expose such containers to heat, flame, sparks, or other sources of ignition. They may explode and cause injury or death. "Empty" drums should be completely drained, properly bunged, and promptly shipped to the supplier or a drum reconditioner. All containers should be disposed of in an environmentally safe manner and in accordance with governmental regulations. Before working on or in tanks which contain or have contained this material, refer to OSHA regulations, ANSI Z49.1, and other references pertaining to cleaning, repairing, welding, or other contemplated operations.

SECTION 8: Exposure controls/personal protection

Occupational exposure limits

The following constituents are the only constituents of the product which have a PEL, TLV or other recommended exposure limit. At this time, the other constituents have no known exposure limits.

Chemical Name	ACGIH	OSHA	Mexico	Phillips 66
Distillates, petroleum, hydrotreated heavy paraffinic	TWA: 5mg/m ³ STEL: 10 mg/m ³ as Oil Mist, if Generated	---	---	---
Distillates, petroleum, solvent-dewaxed heavy paraffinic	TWA: 5mg/m ³ STEL: 10 mg/m ³ as Oil Mist, if Generated	---	---	---
Residual oils, petroleum, solvent-dewaxed	TWA: 5mg/m ³ STEL: 10 mg/m ³ as Oil Mist, if Generated	---	---	---

Note: State, local or other agencies or advisory groups may have established more stringent limits. Consult an industrial hygienist or similar professional, or your local agencies, for further information.

Biological occupational exposure limits

Note: This product, as supplied, does not contain any hazardous materials with occupational exposure limits established by the region specific regulatory bodies

Engineering controls: If current ventilation practices are not adequate to maintain airborne concentrations below the established exposure limits, additional engineering controls may be required.

Eye/Face Protection: The use of eye/face protection is not normally required; however, good industrial hygiene practice suggests the use of eye protection that meets or exceeds ANSI Z.87.1 whenever working with chemicals.

Skin/Hand Protection: The use of skin protection is not normally required; however, good industrial hygiene practice suggests the use of gloves or other appropriate skin protection whenever working with chemicals. Suggested protective materials: Nitrile rubber

Respiratory Protection: Where there is potential for airborne exposure above the exposure limit a NIOSH certified air purifying respirator equipped with R or P95 filters may be used.

A respiratory protection program that meets or is equivalent to OSHA 29 CFR 1910.134 and ANSI Z88.2 should be followed whenever workplace conditions warrant a respirator's use. Air purifying respirators provide limited protection and cannot be used in atmospheres that exceed the maximum use concentration (as directed by regulation or the manufacturer's instructions), in oxygen

LBPH817776 - Multi-Way Oil HD
Issue Date: 16-Apr-2018

Page 4/6
Status: FINAL

deficient (less than 19.5 percent oxygen) situations, or under conditions that are immediately dangerous to life and health (IDLH).

Suggestions provided in this section for exposure control and specific types of protective equipment are based on readily available information. Users should consult with the specific manufacturer to confirm the performance of their protective equipment. Specific situations may require consultation with industrial hygiene, safety, or engineering professionals.

SECTION 9: Physical and chemical properties

Note: Unless otherwise stated, values are determined at 20°C (68°F) and 760 mm Hg (1 atm). Data represent typical values and are not intended to be specifications.

<p>Appearance: Amber, Transparent Physical Form: Liquid Odor: Petroleum Odor Threshold: No data pH: Not applicable Vapor Density (air=1): >1 Upper Explosive Limits (vol % in air): No data Lower Explosive Limits (vol % in air): No data Evaporation Rate (nBuAc=1): No data Particle Size: Not applicable Percent Volatile: No data Flammability (solid, gas): Not applicable Solubility in Water: Insoluble</p>	<p>Flash Point: > 320 °F / > 160 °C Test Method: Pensky-Martens Closed Cup (PMCC), ASTM D93, EPA 1010 Initial Boiling Point/Range: No data Vapor Pressure: <1 mm Hg Partition Coefficient (n-octanol/water) (Kow): No data Melting/Freezing Point: < 5 °F / < -15 °C Auto-ignition Temperature: No data Decomposition Temperature: No data Specific Gravity (water=1): 0.86 - 0.89 @ 60°F (15.6°C) Bulk Density: 7.2 - 7.4 lbs/gal Viscosity: 5 - 20 cSt @ 100°C; 29 - 235 cSt @ 40°C Pour Point: < 5 °F / < -15 °C</p>
---	--

SECTION 10: Stability and reactivity

Reactivity: Not chemically reactive.

Chemical stability: Stable under normal ambient and anticipated conditions of use.

Possibility of hazardous reactions: Hazardous reactions not anticipated.

Conditions to avoid: Extended exposure to high temperatures can cause decomposition. Avoid all possible sources of ignition.

Incompatible materials: Avoid contact with strong oxidizing agents and strong reducing agents.

Hazardous decomposition products: Not anticipated under normal conditions of use.

SECTION 11: Toxicological information

Information on Toxicological Effects

Substance / Mixture	Acute Toxicity	Hazard	Additional Information	LC50/LD50 Data
Inhalation		Unlikely to be harmful		>5 mg/L (mist, estimated)
Dermal		Unlikely to be harmful		> 2 g/kg (estimated)
Oral		Unlikely to be harmful		> 5 g/kg (estimated)

Likely Routes of Exposure: Inhalation, eye contact, skin contact

Aspiration Hazard: Not expected to be an aspiration hazard

Skin Corrosion/Irritation: Not expected to be irritating. Repeated exposure may cause skin dryness or cracking.

Serious Eye Damage/Irritation: Not expected to be irritating.

Skin Sensitization: No information available on the mixture, however none of the components have been classified for skin sensitization (or are below the concentration threshold for classification).

Respiratory Sensitization: No information available.

LBPH817776 - Multi-Way Oil HD
Issue Date: 16-Apr-2018

Page 5/6
Status: FINAL

Specific Target Organ Toxicity (Single Exposure): No information available on the mixture, however none of the components have been classified for target organ toxicity (or are below the concentration threshold for classification).

Specific Target Organ Toxicity (Repeated Exposure): No information available on the mixture, however none of the components have been classified for target organ toxicity (or are below the concentration threshold for classification).

Carcinogenicity: No information available on the mixture, however none of the components have been classified for carcinogenicity (or are below the concentration threshold for classification).

Germ Cell Mutagenicity: No information available on the mixture, however none of the components have been classified for germ cell mutagenicity (or are below the concentration threshold for classification).

Reproductive Toxicity: No information available on the mixture, however none of the components have been classified for reproductive toxicity (or are below the concentration threshold for classification).

Information on Toxicological Effects of Components

Lubricant Base Oil (Petroleum)

Carcinogenicity: The petroleum base oils contained in this product have been highly refined by a variety of processes including severe hydrocracking/hydroprocessing to reduce aromatics and improve performance characteristics. All of the oils meet the IP-346 criteria of less than 3 percent PAH's and are not considered carcinogens by NTP, IARC, or OSHA.

SECTION 12: Ecological information

GHS Classification:

No classified hazards

Toxicity: All acute aquatic toxicity studies on samples of lubricant base oils show acute toxicity values greater than 100 mg/L for invertebrates, algae and fish. These tests were carried out on water accommodated fractions and the results are consistent with the predicted aquatic toxicity of these substances based on their hydrocarbon compositions.

Persistence and Degradability: The hydrocarbons in this material are not readily biodegradable, but since they can be degraded by microorganisms, they are regarded as inherently biodegradable.

Bioaccumulative Potential: Log Kow values measured for the hydrocarbon components of this material are greater than 5.3, and therefore regarded as having the potential to bioaccumulate. In practice, metabolic processes may reduce bioconcentration.

Mobility in Soil: Volatilization to air is not expected to be a significant fate process due to the low vapor pressure of this material. In water, base oils will float and spread over the surface at a rate dependent upon viscosity. There will be significant removal of hydrocarbons from the water by sediment adsorption. In soil and sediment, hydrocarbon components will show low mobility with adsorption to sediments being the predominant physical process. The main fate process is expected to be slow biodegradation of the hydrocarbon constituents in soil and sediment.

Other adverse effects: None anticipated.

SECTION 13: Disposal considerations

The generator of a waste is always responsible for making proper hazardous waste determinations and needs to consider state and local requirements in addition to federal regulations. This material, if discarded as produced, would not be a federally regulated RCRA "listed" hazardous waste and is not believed to exhibit characteristics of hazardous waste. See Sections 7 and 8 for information on handling, storage and personal protection and Section 9 for physical/chemical properties. It is possible that the material as produced contains constituents which are not required to be listed in the SDS but could affect the hazardous waste determination. Additionally, use which results in chemical or physical change of this material could subject it to regulation as a hazardous waste. This material under most intended uses would become "Used Oil" due to contamination by physical or chemical impurities. Whenever possible, Recycle used oil in accordance with applicable federal and state or local regulations. Container contents should be completely used and containers should be emptied prior to discard.

SECTION 14: Transport information

U.S. Department of Transportation (DOT)

UN Number: Not regulated

UN proper shipping name: None

LBPH817776 - Multi-Way Oil HD
 Issue Date: 16-Apr-2018

Page 6/6
 Status: FINAL

Transport hazard class(es): None

Packing Group: None

Environmental Hazards: This product does not meet the DOT/UN/IMDG/IMO criteria of a marine pollutant

Special precautions for user: If shipped by land in a packaging having a capacity of 3,500 gallons or more, the provisions of 49 CFR, Part 130 apply. (Contains oil)

Transport in bulk according to Annex II of MARPOL 73/78 and the IBC Code: Not applicable

SECTION 15: Regulatory information

CERCLA/SARA - Section 302 Extremely Hazardous Substances and TPQs (in pounds)

This material does not contain any chemicals subject to the reporting requirements of SARA 302 and 40 CFR 372.

CERCLA/SARA - Section 311/312 (Title III Hazard Categories)

Should this product meet EPCRA 311/312 Tier reporting criteria at 40 CFR 370, refer to Section 2 of this SDS for appropriate classifications.

CERCLA/SARA - Section 313 and 40 CFR 372

This material does not contain any chemicals subject to the reporting requirements of SARA 313 and 40 CFR 372.

EPA (CERCLA) Reportable Quantity (in pounds)

This material does not contain any chemicals with CERCLA Reportable Quantities.

California Proposition 65

This material does not contain any chemicals which are known to the State of California to cause cancer, birth defects or other reproductive harm at concentrations that trigger the warning requirements of California Proposition 65.

International Inventories

All components are either listed on the US TSCA Inventory, or are not regulated under TSCA.

All components are either on the DSL, or are exempt from DSL listing requirements.

SECTION 16: Other information

Issue Date:	Previous Issue Date:	SDS Number	Status:
16-Apr-2018	23-Jun-2016	LBPH817776	FINAL

Revised Sections or Basis for Revision:

Exposure limits (Section 8); Regulatory information (Section 15)

Legend (pursuant to NOM-018-STPS-2015):

The information within is considered correct but is not exhaustive and will be used for guidance only, which is based on the current knowledge of the substance or mixture and is applicable to the appropriate safety precautions for the product.

Guide to Abbreviations:

ACGIH = American Conference of Governmental Industrial Hygienists; CASRN = Chemical Abstracts Service Registry Number; CEILING = Ceiling Limit (15 minutes); CERCLA = The Comprehensive Environmental Response, Compensation, and Liability Act; EPA = Environmental Protection Agency; GHS = Globally Harmonized System; HPR = Hazardous Products Regulations; IARC = International Agency for Research on Cancer; INSHT = National Institute for Health and Safety at Work; IOPC = International Oil Pollution Compensation; LEL = Lower Explosive Limit; NE = Not Established; NFPA = National Fire Protection Association; NTP = National Toxicology Program; OSHA = Occupational Safety and Health Administration; PEL = Permissible Exposure Limit (OSHA); SARA = Superfund Amendments and Reauthorization Act; STEL = Short Term Exposure Limit (15 minutes); TLV = Threshold Limit Value (ACGIH); TWA = Time Weighted Average (8 hours); UEL = Upper Explosive Limit; WHMIS = Worker Hazardous Materials Information System (Canada)

Disclaimer of Expressed and Implied Warranties:

The information presented in this Safety Data Sheet is based on data believed to be accurate as of the date this Safety Data Sheet was prepared. HOWEVER, NO WARRANTY OF MERCHANTABILITY, FITNESS FOR ANY PARTICULAR PURPOSE, OR ANY OTHER WARRANTY IS EXPRESSED OR IS TO BE IMPLIED REGARDING THE ACCURACY OR COMPLETENESS OF THE INFORMATION PROVIDED ABOVE, THE RESULTS TO BE OBTAINED FROM THE USE OF THIS INFORMATION OR THE PRODUCT, THE SAFETY OF THIS PRODUCT, OR THE HAZARDS RELATED TO ITS USE. No responsibility is assumed for any damage or injury resulting from abnormal use or from any failure to adhere to recommended practices. The information provided above, and the product, are furnished on the condition that the person receiving them shall make their own determination as to the suitability of the product for their particular purpose and on the condition that they assume the risk of their use. In addition, no authorization is given nor implied to practice any patented invention without a license.

Safety Data Sheet

According to OSHA HCS 2012 (29 CFR 1910.1200), Health Canada HPR (SOR/2015-17), and Mexico NOM-018-STPS-2015



SECTION 1: Identification

Product Identifier Alco Super-Lube Multi-Purpose EP-0 Grease
Code 829364
Relevant identified uses Lubricating Grease
Uses advised against All others
24 Hour Emergency Phone Number CHEMTREC 1-800-424-9300
 CHEMTREC México 01-800-681-9531

Manufacturer/Supplier
 Phillips 66 Spectrum Corporation
 500 Industrial Park Drive
 Selmer, TN 38375-3276
 United States of America

SDS Information
 URL: www.Phillips66.com
 Phone: 800-762-0942
 Email: SDS@P66.com

Technical Information
 1-800-264-6457 or +1-731-645-4972

SECTION 2: Hazard identification

Classified Hazards	Hazards Not Otherwise Classified (HNOC)
No classified hazards	PHNOC: None known HHNOC: None known

Label Elements

No classified hazards

SECTION 3: Composition/information on ingredients

Chemical Name	CASRN	Concentration ¹
Distillates, petroleum, hydrotreated heavy naphthenic	64742-52-5	40-70
Distillates, petroleum, hydrotreated heavy paraffinic	64742-54-7	20-40
Boron lithium oxide	12007-60-2	<4

¹ All concentrations are percent by weight unless ingredient is a gas. Gas concentrations are in percent by volume.

SECTION 4: First aid measures

Eye Contact: If irritation or redness develops from exposure, flush eyes with clean water. If symptoms persist, seek medical attention.

Skin Contact: Remove contaminated shoes and clothing and cleanse affected area(s) thoroughly by washing with mild soap and water or a waterless hand cleaner. If irritation or redness develops and persists, seek medical attention. If product is injected into or under the skin, or into any part of the body, regardless of the appearance of the wound or its size, the individual should be evaluated immediately by a physician. (see Note to Physician)

829364 - Alco Super-Lube Multi-Purpose EP-0 Grease
Issue Date: 02-May-2017

Page 1/6
Status: FINAL

829364 - Alco Super-Lube Multi-Purpose EP-0 Grease
 Issue Date: 02-May-2017

Page 2/6
 Status: FINAL

Inhalation: First aid is not normally required. If breathing difficulties develop, move victim away from source of exposure and into fresh air in a position comfortable for breathing. Seek immediate medical attention.

Ingestion: First aid is not normally required; however, if swallowed and symptoms develop, seek medical attention.

Most important symptoms and effects, both acute and delayed: Inhalation of oil mists or vapors generated at elevated temperatures may cause respiratory irritation. Accidental ingestion can result in minor irritation of the digestive tract, nausea and diarrhea. Prolonged or repeated contact may dry skin and cause irritation

Notes to Physician: When using high-pressure equipment, injection of product under the skin can occur. In this case, the casualty should be sent immediately to the hospital. Do not wait for symptoms to develop. High-pressure hydrocarbon injection injuries may produce substantial necrosis of underlying tissue despite an innocuous appearing external wound. These injuries often require extensive emergency surgical debridement and all injuries should be evaluated by a specialist in order to assess the extent of injury. Early surgical treatment within the first few hours may significantly reduce the ultimate extent of injury.

SECTION 5: Firefighting measures

NFPA 704 Hazard Class

Health: 0 Flammability: 1 Instability: 0



0 (Minimal)
 1 (Slight)
 2 (Moderate)
 3 (Serious)
 4 (Severe)

Extinguishing Media: Dry chemical, carbon dioxide, foam, or water spray is recommended. Water or foam may cause frothing of materials heated above 212°F / 100°C. Carbon dioxide can displace oxygen. Use caution when applying carbon dioxide in confined spaces. Simultaneous use of foam and water on the same surface is to be avoided as water destroys the foam.

Specific hazards arising from the chemical

Unusual Fire & Explosion Hazards: This material may burn, but will not ignite readily. If container is not properly cooled, it can rupture in the heat of a fire.

Hazardous Combustion Products: Combustion may yield smoke, carbon monoxide, and other products of incomplete combustion. Oxides of sulfur, nitrogen or phosphorus may also be formed.

Special protective actions for fire-fighters: For fires beyond the initial stage, emergency responders in the immediate hazard area should wear protective clothing. When the potential chemical hazard is unknown, in enclosed or confined spaces, a self contained breathing apparatus should be worn. In addition, wear other appropriate protective equipment as conditions warrant (see Section 8). Isolate the hazard area and deny entry to unnecessary and unprotected personnel. Stop spill/release if it can be done safely. Move undamaged containers from immediate hazard area if it can be done safely. Water spray may be useful in minimizing or dispersing vapors and to protect personnel. Cool equipment exposed to fire with water, if it can be done safely. Avoid spreading burning liquid with water used for cooling purposes.

See Section 9 for Flammable Properties including Flash Point and Flammable (Explosive) Limits

SECTION 6: Accidental release measures

Personal precautions, protective equipment and emergency procedures: This material may burn, but will not ignite readily. Keep all sources of ignition away from spill/release. Stay upwind and away from spill/release. Avoid direct contact with material. For large spillages, notify persons down wind of the spill/release, isolate immediate hazard area and keep unauthorized personnel out. Wear appropriate protective equipment, including respiratory protection, as conditions warrant (see Section 8). See Sections 2 and 7 for additional information on hazards and precautionary measures.

Environmental Precautions: Stop and contain spill/release if it can be done safely. Prevent spilled material from entering sewers, storm drains, other unauthorized drainage systems, and natural waterways. Use water sparingly to minimize environmental contamination and reduce disposal requirements. If spill occurs on water notify appropriate authorities and advise shipping of any hazard. Spills into or upon navigable waters, the contiguous zone, or adjoining shorelines that cause a sheen or discoloration on the surface of the water, may require notification of the National Response Center (phone number 800-424-8802).

829364 - Alco Super-Lube Multi-Purpose EP-0 Grease
 Issue Date: 02-May-2017

Page 3/6
 Status: FINAL

Methods and material for containment and cleaning up: Notify relevant authorities in accordance with all applicable regulations. Immediate cleanup of any spill is recommended. Dike far ahead of spill for later recovery or disposal. Absorb spill with inert material such as sand or vermiculite, and place in suitable container for disposal. If spilled on water remove with appropriate methods (e.g. skimming, booms or absorbents). In case of soil contamination, remove contaminated soil for remediation or disposal, in accordance with local regulations.

Recommended measures are based on the most likely spillage scenarios for this material; however local conditions and regulations may influence or limit the choice of appropriate actions to be taken. See Section 13 for information on appropriate disposal.

SECTION 7: Handling and storage

Precautions for safe handling: Keep away from flames and hot surfaces. Wash thoroughly after handling. Use good personal hygiene practices and wear appropriate personal protective equipment (see section 8). High pressure injection of hydrocarbon fuels, hydraulic oils or greases under the skin may have serious consequences even though no symptoms or injury may be apparent. This can happen accidentally when using high pressure equipment such as high pressure grease guns, fuel injection apparatus or from pinhole leaks in tubing of high pressure hydraulic oil equipment.

Do not enter confined spaces such as tanks or pits without following proper entry procedures such as ASTM D-4276 and 29CFR 1910.146. Do not wear contaminated clothing or shoes.

Conditions for safe storage: Keep container(s) tightly closed and properly labeled. Use and store this material in cool, dry, well-ventilated area away from heat and all sources of ignition. Store only in approved containers. Keep away from any incompatible material (see Section 10). Protect container(s) against physical damage.

"Empty" containers retain residue and may be dangerous. Do not pressurize, cut, weld, braze, solder, drill, grind, or expose such containers to heat, flame, sparks, or other sources of ignition. They may explode and cause injury or death. "Empty" drums should be completely drained, properly bunged, and promptly shipped to the supplier or a drum reconditioner. All containers should be disposed of in an environmentally safe manner and in accordance with governmental regulations. Before working on or in tanks which contain or have contained this material, refer to OSHA regulations, ANSI Z49.1, and other references pertaining to cleaning, repairing, welding, or other contemplated operations.

SECTION 8: Exposure controls/personal protection

Chemical Name	ACGIH	OSHA	Mexico	Phillips 66
Distillates, petroleum, hydrotreated heavy naphthenic	TWA: 5mg/m ³ STEL: 10 mg/m ³ as Oil Mist, if Generated	---	---	---
Distillates, petroleum, hydrotreated heavy paraffinic	TWA: 5mg/m ³ STEL: 10 mg/m ³ as Oil Mist, if Generated	---	---	---

Note: State, local or other agencies or advisory groups may have established more stringent limits. Consult an industrial hygienist or similar professional, or your local agencies, for further information.

Engineering controls: If current ventilation practices are not adequate to maintain airborne concentrations below the established exposure limits, additional engineering controls may be required.

Eye/Face Protection: The use of eye protection that meets or exceeds ANSI Z.87.1 is recommended to protect against potential eye contact, irritation, or injury. Depending on conditions of use, a face shield may be necessary.

Skin/Hand Protection: The use of gloves impervious to the specific material handled is advised to prevent skin contact. Users should check with manufacturers to confirm the breakthrough performance of their products.

Respiratory Protection: Respiratory protection is not normally required under intended conditions of use. Emergencies or conditions that could result in significant airborne exposures may require the use of NIOSH approved respiratory protection. An industrial hygienist or other appropriate health and safety professional should be consulted for specific guidance under these situations.

Suggestions provided in this section for exposure control and specific types of protective equipment are based on readily available information. Users should consult with the specific manufacturer to confirm the performance of their protective equipment. Specific situations may require consultation with industrial hygiene, safety, or engineering professionals.

829364 - Alco Super-Lube Multi-Purpose EP-0 Grease
 Issue Date: 02-May-2017

Page 4/6
 Status: FINAL

SECTION 9: Physical and chemical properties

Note: Unless otherwise stated, values are determined at 20°C (68°F) and 760 mm Hg (1 atm). Data represent typical values and are not intended to be specifications.

Appearance: Green	Flash Point: 257 °F / 125 °C
Physical Form: Semi-Solid	Test Method: Cleveland Open Cup (COC), ASTM D92
Odor: Slight hydrocarbon	Initial Boiling Point/Range: No data
Odor Threshold: No data	Vapor Pressure: <1 mm Hg
pH: Not applicable	Partition Coefficient (n-octanol/water) (Kow): No data
Vapor Density (air=1): <1	Melting/Freezing Point: No data
Upper Explosive Limits (vol % in air): No data	Auto-ignition Temperature: No data
Lower Explosive Limits (vol % in air): No data	Decomposition Temperature: No data
Evaporation Rate (nBuAc=1): No data	Specific Gravity (water=1): 0.87 @ 60°F (15.6°C)
Particle Size: Not applicable	Bulk Density: 7.5 lbs/gal
Percent Volatile: No data	Viscosity: No data
Flammability (solid, gas): Not applicable	Solubility in Water: Negligible

SECTION 10: Stability and reactivity

Reactivity: Not chemically reactive.

Chemical stability: Stable under normal ambient and anticipated conditions of use.

Possibility of hazardous reactions: Hazardous reactions not anticipated.

Conditions to avoid: Extended exposure to high temperatures can cause decomposition. Avoid all possible sources of ignition.

Incompatible materials: Avoid contact with strong oxidizing agents and strong reducing agents.

Hazardous decomposition products: Not anticipated under normal conditions of use.

SECTION 11: Toxicological information

Information on Toxicological Effects

Substance / Mixture	Hazard	Additional Information	LC50/LD50 Data
Acute Toxicity			
Inhalation	Unlikely to be harmful		>5 mg/L (mist, estimated)
Dermal	Unlikely to be harmful		> 2 g/kg (estimated)
Oral	Unlikely to be harmful		> 5 g/kg (estimated)

Aspiration Hazard: Not expected to be an aspiration hazard

Skin Corrosion/Irritation: Causes mild skin irritation. Repeated exposure may cause skin dryness or cracking.

Serious Eye Damage/Irritation: Causes mild eye irritation.

Skin Sensitization: No information available on the mixture, however none of the components have been classified for skin sensitization (or are below the concentration threshold for classification).

Respiratory Sensitization: No information available.

Specific Target Organ Toxicity (Single Exposure): No information available on the mixture, however none of the components have been classified for target organ toxicity (or are below the concentration threshold for classification).

Specific Target Organ Toxicity (Repeated Exposure): No information available on the mixture, however none of the components have been classified for target organ toxicity (or are below the concentration threshold for classification).

Carcinogenicity: No information available on the mixture, however none of the components have been classified for

829364 - Alco Super-Lube Multi-Purpose EP-0 Grease
Issue Date: 02-May-2017

Page 5/6
Status: FINAL

carcinogenicity (or are below the concentration threshold for classification).

Germ Cell Mutagenicity: No information available on the mixture, however none of the components have been classified for germ cell mutagenicity (or are below the concentration threshold for classification).

Reproductive Toxicity: No information available on the mixture, however none of the components have been classified for reproductive toxicity (or are below the concentration threshold for classification).

Information on Toxicological Effects of Components

Lubricant Base Oil (Petroleum)

Carcinogenicity: The petroleum base oils contained in this product have been highly refined by a variety of processes including severe hydrocracking/hydroprocessing to reduce aromatics and improve performance characteristics. All of the oils meet the IP-346 criteria of less than 3 percent PAH's and are not considered carcinogens by NTP, IARC, or OSHA.

SECTION 12: Ecological information

GHS Classification:

No classified hazards

Toxicity: All acute aquatic toxicity studies on samples of lubricant base oils show acute toxicity values greater than 100 mg/L for invertebrates, algae and fish. These tests were carried out on water accommodated fractions and the results are consistent with the predicted aquatic toxicity of these substances based on their hydrocarbon compositions.

Persistence and Degradability: The hydrocarbons in this material are not readily biodegradable, but since they can be degraded by microorganisms, they are regarded as inherently biodegradable.

Bioaccumulative Potential: Log Kow values measured for the hydrocarbon components of this material are greater than 5.3, and therefore regarded as having the potential to bioaccumulate. In practice, metabolic processes may reduce bioconcentration.

Mobility in Soil: Volatilization to air is not expected to be a significant fate process due to the low vapor pressure of this material. In water, base oils will float and spread over the surface at a rate dependent upon viscosity. There will be significant removal of hydrocarbons from the water by sediment adsorption. In soil and sediment, hydrocarbon components will show low mobility with adsorption to sediments being the predominant physical process. The main fate process is expected to be slow biodegradation of the hydrocarbon constituents in soil and sediment.

Other adverse effects: None anticipated.

SECTION 13: Disposal considerations

The generator of a waste is always responsible for making proper hazardous waste determinations and needs to consider state and local requirements in addition to federal regulations. This material, if discarded as produced, would not be a federally regulated RCRA "listed" hazardous waste and is not believed to exhibit characteristics of hazardous waste. See Sections 7 and 8 for information on handling, storage and personal protection and Section 9 for physical/chemical properties. It is possible that the material as produced contains constituents which are not required to be listed in the SDS but could affect the hazardous waste determination. Additionally, use which results in chemical or physical change of this material could subject it to regulation as a hazardous waste. Container contents should be completely used and containers should be emptied prior to discard.

SECTION 14: Transport information

U.S. Department of Transportation (DOT)

UN Number: Not regulated

UN proper shipping name: None

Transport hazard class(es): None

Packing Group: None

Environmental Hazards: This product does not meet the DOT/UN/IMDG/IMO criteria of a marine pollutant

Special precautions for user: None

Transport in bulk according to Annex II of MARPOL 73/78 and the IBC Code: Not applicable

SECTION 15: Regulatory information

CERCLA/SARA - Section 302 Extremely Hazardous Substances and TPQs (in pounds)

829364 - Alco Super-Lube Multi-Purpose EP-0 Grease
Issue Date: 02-May-2017

Page 6/6
Status: FINAL

 This material does not contain any chemicals subject to the reporting requirements of SARA 302 and 40 CFR 372.

CERCLA/SARA - Section 311/312 (Title III Hazard Categories)

US EPA has published a final rule aligning hazardous chemical reporting under sections 311 and 312 of the Emergency Planning and Community Right-to-Know Act (EPCRA) with OSHA HCS. See Section 2 for hazard classifications under EPCRA.

CERCLA/SARA - Section 313 and 40 CFR 372

This material does not contain any chemicals subject to the reporting requirements of SARA 313 and 40 CFR 372.

Chemical Name	Concentration ¹	de minimis
Zinc Compound(s)	<2	1.0%

EPA (CERCLA) Reportable Quantity (in pounds)

This material does not contain any chemicals with CERCLA Reportable Quantities.

California Proposition 65

This material does not contain any chemicals which are known to the State of California to cause cancer, birth defects or other reproductive harm at concentrations that trigger the warning requirements of California Proposition 65.

International Inventories

All components are either listed on the US TSCA Inventory, or are not regulated under TSCA. All components are either on the DSL, or are exempt from DSL listing requirements.

SECTION 16: Other information

Issue Date:	Previous Issue Date:	SDS Number	Status:
02-May-2017	31-Jul-2015	829364	FINAL

Revised Sections or Basis for Revision:

Identified Hazards (Section 2); Composition (Section 3); Format change

Legend (pursuant to NOM-018-STPS-2015):

The information within is considered correct but is not exhaustive and will be used for guidance only, which is based on the current knowledge of the substance or mixture and is applicable to the appropriate safety precautions for the product.

Guide to Abbreviations:

ACGIH = American Conference of Governmental Industrial Hygienists; CASRN = Chemical Abstracts Service Registry Number; CEILING = Ceiling Limit (15 minutes); CERCLA = The Comprehensive Environmental Response, Compensation, and Liability Act; EPA = Environmental Protection Agency; GHS = Globally Harmonized System; HPR = Hazardous Products Regulations; IARC = International Agency for Research on Cancer; INSHT = National Institute for Health and Safety at Work; IOPC = International Oil Pollution Compensation; LEL = Lower Explosive Limit; NE = Not Established; NFPA = National Fire Protection Association; NTP = National Toxicology Program; OSHA = Occupational Safety and Health Administration; PEL = Permissible Exposure Limit (OSHA); SARA = Superfund Amendments and Reauthorization Act; STEL = Short Term Exposure Limit (15 minutes); TLV = Threshold Limit Value (ACGIH); TWA = Time Weighted Average (8 hours); UEL = Upper Explosive Limit; WHMIS = Worker Hazardous Materials Information System (Canada)

Disclaimer of Expressed and implied Warranties:

The information presented in this Safety Data Sheet is based on data believed to be accurate as of the date this Safety Data Sheet was prepared. HOWEVER, NO WARRANTY OF MERCHANTABILITY, FITNESS FOR ANY PARTICULAR PURPOSE, OR ANY OTHER WARRANTY IS EXPRESSED OR IS TO BE IMPLIED REGARDING THE ACCURACY OR COMPLETENESS OF THE INFORMATION PROVIDED ABOVE, THE RESULTS TO BE OBTAINED FROM THE USE OF THIS INFORMATION OR THE PRODUCT, THE SAFETY OF THIS PRODUCT, OR THE HAZARDS RELATED TO ITS USE. No responsibility is assumed for any damage or injury resulting from abnormal use or from any failure to adhere to recommended practices. The information provided above, and the product, are furnished on the condition that the person receiving them shall make their own determination as to the suitability of the product for their particular purpose and on the condition that they assume the risk of their use. In addition, no authorization is given nor implied to practice any patented invention without a license.