

# ROTTLER

## P69AHD CNC 5 AXIS DIGITIZING & PORTING MACHINE

OPERATION AND MAINTENANCE MANUAL

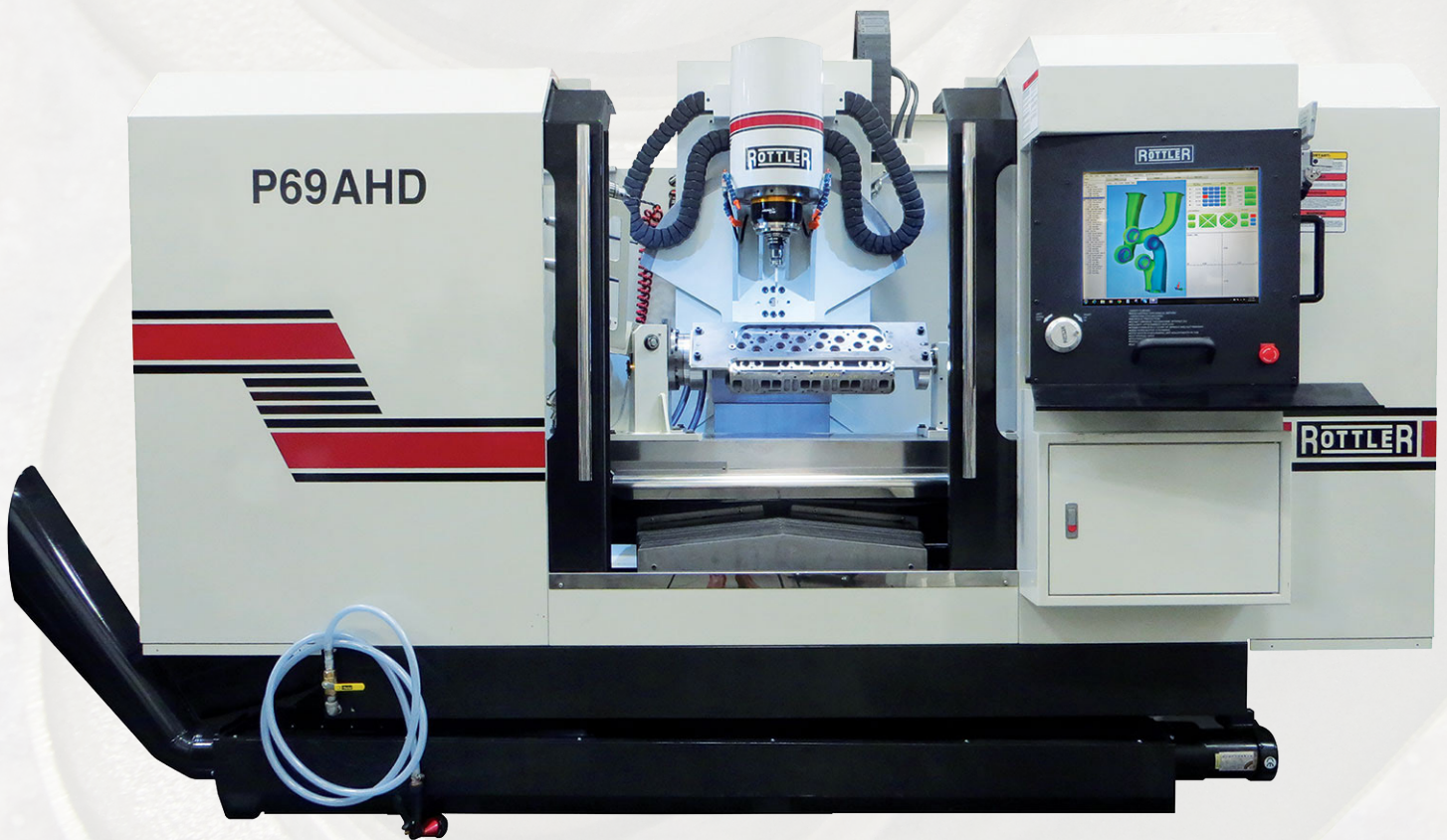



# **MANUAL SECTIONS**

**INTRODUCTION**

**INSTALLATION**

**SAFETY**

**CONTROL DEFINITIONS**

**OPERATING INSTRUCTIONS**

**MAINTENANCE**

**TROUBLESHOOTING**

**MACHINE PARTS**

**OPTIONS**

**MSDS**

## **ORDERING PROCEDURE**

Contact your regional Rottler sales rep for assistance in ordering optional equipment, replacement parts, or tooling.

If you are unable to contact your regional Rottler sales rep, call the factory at 253-872-7050 and ask to speak to the parts sales specialist.

Have the following information handy to expedite the ordering process:

1. Your name, business name, and contact number
2. Customer number
3. If you don't have a customer number, your billing address
4. Shipping address if different from billing address
5. Machine model and serial number
6. Part number and description of what you want to order
7. Preferred method of shipment
8. You may also contact us via e-mail with the above information. Send e-mail requests to:  
[parts@rottlermfg.com](mailto:parts@rottlermfg.com)

In some cases you may be requested to send a photo of the part you are ordering if it is a replacement part, or doesn't appear in the database.

If you are unsure which part you need to order, contact our service department and ask to speak to one of our service consultants. They will assist you in determining which part you require.

**THERE IS A MINIMUM ORDER OF \$25.00**





# INTRODUCTION

## Contents

<b>Introduction.....</b>	<b>1-1</b>
<b>Description.....</b>	<b>1-2</b>
<b>Disclaimer .....</b>	<b>1-2</b>
<b>Limited Warranty .....</b>	<b>1-3</b>
<b>Online Documentation Access.....</b>	<b>1-4</b>

## Introduction

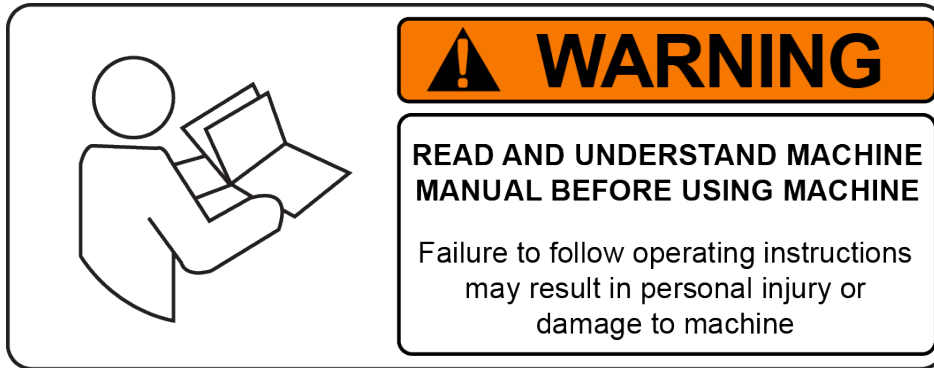

**READ THE SAFETY CHAPTER BEFORE INSTALLING MACHINE. THOROUGHLY UNDERSTAND ALL SAFETY ISSUES BEFORE OPERATING MACHINE.**

### **ATTENTION OWNER/BUSINESS MANAGER**

**To validate the warranty on your new Rottler machine, please be sure to sign and complete the “Installation Report” located in the Installation Chapter of this manual.**

We suggest that the new user of the P69AHD read the CONTROL DEFINITIONS to get an idea how the machine operates.

The Operating Instructions chapter should be read in order to familiarize the user with the actual button pushing sequences required to carry out a job. These chapters in the manual should be considered an introduction. As the operators of the P69AHD series machines gain experience with using the different functions of the machine, complicated setups and programs will make more sense.

The rest of the manual contains information and part number reference on fixtures, cutting tools, and machine maintenance. The operator should read and become familiar with these areas as well.

## Description

The Rottler P69AHD is a 5-axis CNC machine designed and developed specially for porting cylinder heads. The design of the machine allows the center of the “ball shaped” cutting tool to rotate about its own center on the 5th axis.

This unique design has many benefits to a performance engine builder of which the most important are ease of programming and the fastest and most accurate method to port cylinder heads.

## Disclaimer

The P69AHD Manual (henceforth to be referred to as the “Manual”) is proprietary to Rottler Manufacturing LLC. (“Rottler Manufacturing”) and no ownership rights are hereby transferred. No part of the Manual shall be used, reproduced, translated, converted, adapted, stored in a retrieval system, communicated or transmitted by any means, for any commercial purpose, including without limitation, sale, resale, license, rental or lease, without the prior express written consent of Rottler Manufacturing.

Rottler Manufacturing does not make any representations, warranties or guarantees, express or implied, as to the accuracy or completeness of the Manual. Users must be aware that updates and amendments will be made from time to time to the Manual. It is the user’s responsibility to determine whether there have been any such updates or amendments. Neither Rottler Manufacturing nor any of its directors, officers, employees or agents shall not be liable in any manner whatsoever to any person for any loss, damage, injury, liability, cost or expense of any nature, including without limitation incidental, special, direct or consequential damages arising out of or in connection with the use of the Manual.

Rottler Manufacturing and its employees or representatives are not responsible for any information regarding final specifications of any workpiece that is created as a final product when using Rottler equipment. It is the responsibility of the end user of Rottler equipment to determine the final dimensions and finishes of the workpiece that they are working on. Any information regarding final dimensions and finishes that appears in any Rottler literature or that is expressed by anyone representing Rottler is to be regarded as general information to help with the demonstration of or for operator training of Rottler equipment.

## Limited Warranty

Rottler Manufacturing Company Model P69AHD parts and equipment is warranted as to materials and workmanship. This limited warranty remains in effect for one year from the date of installation or two years from the date of the original shipment from Rottler or whichever date occurs first. This only applies if the machine is owned and operated by the original purchaser and is operated and maintained as per the instructions in the manual. A machine is warranted only if the Installation Report has been properly executed by a certified installation person and received by Rottler at the time of actual installation.

The products are warranted upon delivery to conform to their published specifications and to be free from defects in material and workmanship under normal use for a period of one year from shipment. Should a product not be as warranted, Rottler sole obligation shall be, at its option, to repair, correct or replace the product or to refund the amounts paid for the Product upon its return to a location designated by Rottler. No warranty shall extend to rapid wear Products (including tooling) or to Products which have been subject to misuse (including any use contrary to Rottler instructions), neglect, accident (including during shipment), improper handling or installation, or subject to any modification, repair or service not certified by Rottler. Rottler shall not be liable for any consequential, direct or indirect damages or for any other injury or loss. Buyer waives any right, beyond the foregoing warranty, to make a claim against Rottler. No warranty is provided for any Products not paid in full.

Merchandise cannot be returned to Rottler without prior approval. Customer must contact the Order Department or representative to get approval and to be issued a Return Goods Authorization number (RGR#). Merchandise authorized for return must be returned prepaid. If merchandise is returned with shipping charges collect, the actual amount of these charges may be deducted from any credit which may be due the customer. The RGR # assigned by the Order Department should be written on the shipping label and must appear on a copy of the invoice(s) covering the original shipment. This invoice copy must be included in the box with the parts. Shipment must contain ONLY those items on the RGR as approved for return. Merchandise must be received within 10 days of the date of RGR or the RGR will be canceled. All returned merchandise may be subject to a 20% restocking fee on under \$1,000.00 amount or 10% on any items over \$1,000.00. Parts or tooling over 30 days old are considered as customer property and can only be returned with prior written approval from Rottler Corporation Management and/or Shipping Department.

***The issuance of a RGR DOES NOT guarantee credit*** - it is only authorization for the return of the goods. Credit for return merchandise is at the sole discretion of Rottler. Credit will be issued only after inspection of returned goods.

Tools proven to be defective within the warranty period will be repaired or replaced at the factory's option. We accept no responsibility for defects caused by external damage, wear, abuse, or misuse, nor do we accept any obligation to provide compensation for direct or indirect costs in connection with cases covered by the warranty.

### Online Documentation Access

Online documentation for machines and optional equipment can be accessed at the Rottler website. To access documentation open your browser and navigate to <https://www.rottlermfg.com>.

Scroll to the bottom of the page and under the Owner Resources title click the type of documentation you want to access.

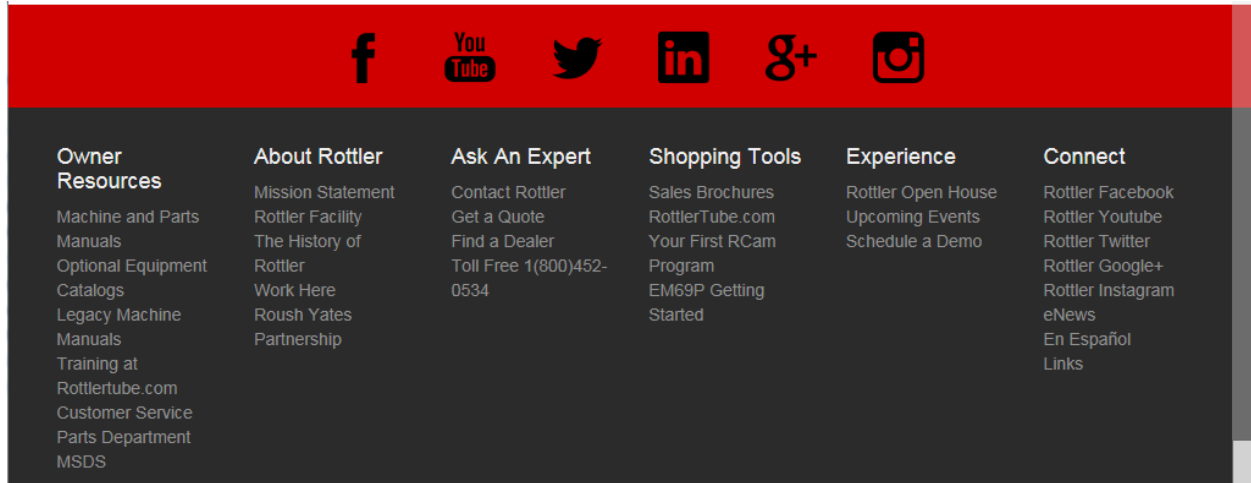

If a log in window pops up asking for user name and password fill in the blanks as shown.

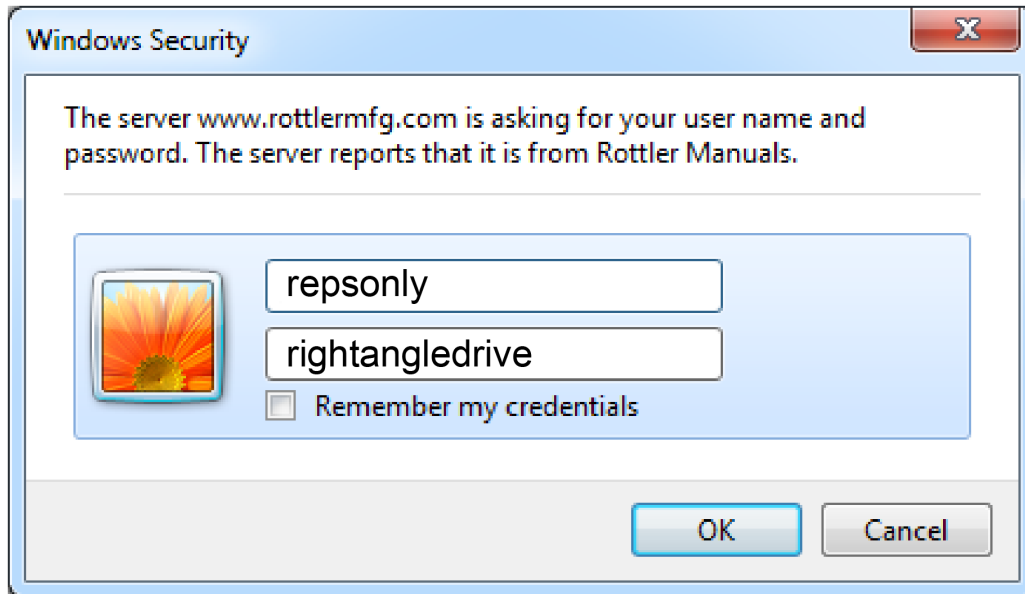



This page intentionally left blank

# INSTALLATION

## Contents

<b>P69AHD installation Report.....</b>	<b>2-2</b>
<b>Machine Dimensions.....</b>	<b>2-8</b>
<b>Front Dimensions .....</b>	<b>2-8</b>
<b>Side Dimensions.....</b>	<b>2-9</b>
<b>Clearance Dimensions .....</b>	<b>2-10</b>
<b>Leveling Bolt Locations .....</b>	<b>2-11</b>
<b>Installation Procedure.....</b>	<b>2-12</b>
<b>Location.....</b>	<b>2-12</b>
<b>Unpacking and Lifting.....</b>	<b>2-12</b>
<b>Power Supply.....</b>	<b>2-13</b>
<b>Grounding.....</b>	<b>2-14</b>
<b>Creating a Skype Account.....</b>	<b>2-15</b>

## **ATTENTION OWNER/BUSINESS MANAGER**

**To validate the warranty on your new Rottler machine, please be sure to sign the installation report after the installation technician has installed the machine and verified the machine is operating correctly and given the operators operation and maintenance training.**

**Thank you for your cooperation and the opportunity to be of service to you.**

***ROTTLER MANUFACTURING***



OFFICE USE ONLY  
Route to: Servicer Mgr → Accounting → Andy → Accounting Warranty Exp Date

**ROTTLER MANUFACTURING MUST HAVE THIS REPORT RETURNED TO PROPERLY QUALIFY WARRANTY ON EQUIPMENT**

Customer: \_\_\_\_\_ Address: \_\_\_\_\_  
City: \_\_\_\_\_ State: \_\_\_\_\_ Zip: \_\_\_\_\_ Phone: \_\_\_\_\_  
Country: \_\_\_\_\_  
Machine Model: \_\_\_\_\_ Serial Number: \_\_\_\_\_ Representative: \_\_\_\_\_

**MACHINE INSTALLATION:** Electrical information MUST be complete to validate this report.

\_\_\_\_\_ Customer has read and fully understands importance of machine location as explained in the installation section of the manual.

**Customer responsibility prior to the arrival of Rottler Sales/Service technician. Please Initial each item when it is completed.**

*Customer is responsible for providing electricity to machine in a manner that meets the local electrical code requirements.*



**VERY IMPORTANT:** Modern design machines contain electronic low voltage circuitry that provides great advantages and a better machine life. BUT, you must have an excellent, stable, isolated power supply along with an isolated ground. If not, electrical noise problems are likely to interfere with machine operation unexpectedly.

- \_\_\_\_\_ Remove machine from truck.
- \_\_\_\_\_ Remove fixturing and misc. from machine and clean.
- \_\_\_\_\_ Install machine with jack pads under jacking bolts. Refer to the Machine Installation section in chapter 2 of the P69AHD manual for proper uncrating and leveling instructions.
- \_\_\_\_\_ This machine requires between 208 and 240 Volts AC, Three Phase, 50/60 Hz, isolated power supply. For voltages above 240 or below 208 VAC, a 17kva transformer will be required and is available at Rottler. Please specify voltage when ordering. Measure the incoming voltage between L1 and L2, L2 and L3, and L1 and L3. Current requirements for this machine is 60 amps. Measure the incoming AC voltage at least twice during installation.
  1. L1to L2 \_\_\_\_\_ VAC, L2 to L3 \_\_\_\_\_ VAC, L1 to L3 \_\_\_\_\_
  2. L1to L2 \_\_\_\_\_ VAC, L2 to L3 \_\_\_\_\_ VAC, L1 to L3 \_\_\_\_\_
- \_\_\_\_\_ Measure each leg of the incoming supply to ground. Sometimes you may find a "high" leg to ground. When this happens make sure the high leg is running to L3.
 

L1 to ground \_\_\_\_\_ VAC L2 to ground \_\_\_\_\_ VAC L3 to ground \_\_\_\_\_ VAC



Neutral and machine ground are not the same thing. You should measure an open circuit between Neutral and ground.

**CAUTION** IF VOLTAGE IS OUTSIDE THE CORRECT RANGE AT ANY TIME THE MACHINE WILL NOT OPERATE PROPERLY AND MAY BE DAMAGED.

\_\_\_\_\_ The P69AHD machine must have a ground rod installed. Not having a ground rod installed can cause unexpected movement of the machine. Refer to the Operation Manual for correct installation of the ground rod.

\_\_\_\_\_ Briefly describe the isolated ground connection to the machine you have made: (Instructions to make a correct isolated ground are included in the operating manual.)

\_\_\_\_\_

\_\_\_\_\_

\_\_\_\_\_ Air of the proper pressure and capacity connected to the machine. Air supply must be free from oil and water. Oil or water will damage electrical and air components.

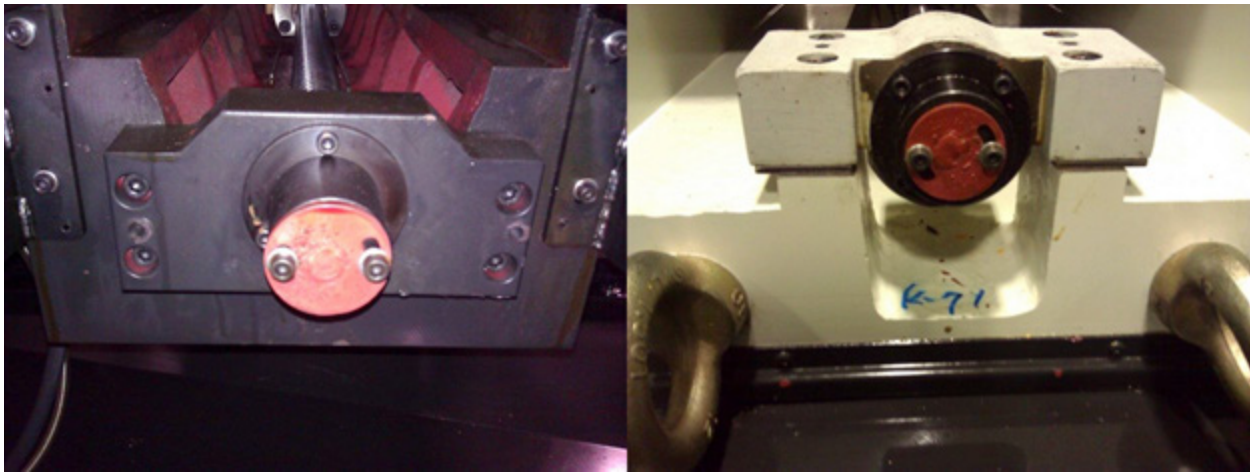

\_\_\_\_\_ Remove the ball screw locks on the left side of the table for the X axis, and the front of the table for the Y axis. They may be covered up by the way covers.

\_\_\_\_\_ Place a thin film of silicone on one side of the ball screw caps and install them in place of both the X and Y axis locks.

\_\_\_\_\_ Air of the proper pressure and capacity connected to the machine. Air supply must be free from oil and water. Oil or water will damage electrical and air components.

\_\_\_\_\_ Customer should attempt to have junk work piece available.

\_\_\_\_\_ Have the operator read through the operation manual before training begins. This will help him be familiar with the button pushing sequences. Have the operator read through the manual again after training and some of the sequences will make more sense.

\_\_\_\_\_ Have Internet connection available for the machine. Either via Ethernet cable or Wireless (Wi-Fi). The machine comes equipped with a wireless USB adapter.

#### **Rottler technician Installation checklist:**

\_\_\_\_\_ **BEFORE** turning power on to the machine. Check all wires for security by using the correct screw driver and turning CW until movement stops. Stranded wire can “spread” slightly from vibration during transport.

\_\_\_\_\_ Install electrical component covers inside the electrical enclosure with fasteners provided.

\_\_\_\_\_ Each main system is protected internally by circuit breakers. Green the breaker is “tripped” and red indicates the breaker is “Hot” (conducting electricity).



- \_\_\_\_\_ Clean any rust inhibitor from the machine surfaces. Remove the way covers from the front and back of the Y (In/Out) Axis. Clean the rust inhibitor from exposed areas of the In/Out and Vertical axis. If the side trays for the Horizontal have been put on the machine, remove them. Use cleaner such as WD40 or Kerosene to clean the ways. Remove way wipers and clean each wiper.
- \_\_\_\_\_ Remove all rust inhibitor from the axis way surfaces.

 **CAUTION** *Do not attempt to move any axis until all rust inhibitor has been removed.*

- \_\_\_\_\_ Reinstall way wipers. Confirm that all wipers make full contact with way surfaces.
- \_\_\_\_\_ Check the exterior of the limit switch for any shipping preservative and wipe clean if required.

Note: The positioning of the machine in small increments will be detrimentally affected if all rust inhibitor is not removed from the ways.

- \_\_\_\_\_ Remind customer air of the proper pressure and capacity connected to the machine. Air supply must be free from oil and water. Oil or water will damage electrical and air components.
- \_\_\_\_\_ Connect electrical wires in main rear enclosure if required using machine wiring diagram.

### MACHINE START-UP

 **CAUTION** When starting the machine for the first time, it may move out of control. Make sure all hands are clear of machine parts. Be ready to press the Emergency Stop button if needed.

- \_\_\_\_\_ E-stop should be pushed in before turning the machine on for the first time.
- \_\_\_\_\_ Turn main power on at the main disconnect switch located on the rear enclosure.
- \_\_\_\_\_ If machine moves out of control, turn power off and contact factory for help in trouble shooting.
- \_\_\_\_\_ If any of the circuit breakers “trip”, reset and call factory for possible trouble shooting.

### MACHINE MOVEMENTS

- \_\_\_\_\_ Make sure there is nothing obstructing the full vertical or horizontal travel of the machine taking special notice of the rear enclosure, way travel and top of the spindle unit.
- \_\_\_\_\_ Put the machine in hand wheel mode and verify Vertical operation. Put an indicator on the cutter head and verify .001” movement per detent in course mode and .0001” in fine mode. If the indicator is jumpy the outer spindle adjustment may be too tight. Refer to manual and re-adjust.
- \_\_\_\_\_ Put the machine in hand wheel mode and verify Horizontal operation. Put an indicator on the cutter head and verify .001” movement per detent in course mode and .0001” in fine mode
- \_\_\_\_\_ Put the machine in hand wheel mode and verify Vertical operation.
- \_\_\_\_\_ Put the machine in hand wheel mode and verify Horizontal operation.
- \_\_\_\_\_ Put the machine in hand wheel mode and verify A axis operation.
- \_\_\_\_\_ Put the machine in hand wheel mode and verify B axis operation.
- \_\_\_\_\_ Use the rapid buttons and verify proper vertical, horizontal, A axis, and B axis travel.
- \_\_\_\_\_ Move the machine to its vertical, horizontal, A axis and B axis limits and verify Home and down limit operation.
- \_\_\_\_\_ Move the machine to its horizontal limits and verify operation of the left and right limit switches.
- \_\_\_\_\_ Start the spindle and verify operation at all speeds.
- \_\_\_\_\_ Use the spindle creep buttons and verify proper operation.
- \_\_\_\_\_ Level the machine:

**INSTRUCTING THE OPERATOR:**

**Note: Rottler employees and representatives per company policy are not permitted to provide end user of Rottler equipment with any OEM specifications for the workpiece that is created by end user using Rottler equipment.**

 **WARNING**

- \_\_\_\_\_ Explain to the customer and operator that at NO time is there to be any software or hardware other than Windows Auto Update and Rottler installed on this machine. This includes screen savers, anti-virus software, and any hardware device that installs software on the machine. Installation of screen savers and anti-virus software can cause dangerous control problems. Any installation of software or hardware will void the warranty on the machine.
- \_\_\_\_\_ Explain to the customer and operator that the machine should be hooked up to the Internet anytime it is on. The software on the machine will automatically connect to our server to send back useful information on machine status.
- \_\_\_\_\_ Connect customer supplied Internet to the machine. Verify that the Internet is accessible from the machine.
- \_\_\_\_\_ Once the machine has been fully setup and is ready for operation create a Skype account for the machine following the instructions in the Installation Section of the manual.
- \_\_\_\_\_ Explain to the customer and the operator how the to log onto Skype and communicate with Rottler when needed.

 **WARNING**

- \_\_\_\_\_ Computer Viruses will cause the machine control system to become unstable. This may cause the machine to make uncontrolled moves which could create a dangerous environment for the machine operator.
- \_\_\_\_\_ Refer to Chapter 4, Control Definitions of the Machine Manual, Section: Computer and Controller System Safety. Explain and discuss this section carefully with Owner/Manager/Operator and have them sign off. Failure to do so will result in the machine warranty being Null and Void.

---

Signature / Title

- \_\_\_\_\_ Explain to the customer the importance of backing up the block profiles to a separate device. Any computer failure or possible operator input error can result in the loss of all block profiles that were created for the machine. Refer to Chapter 5 of the machine manual for detailed instructions on backing up and restoring block profiles.
- \_\_\_\_\_ Install and test the Internet connection to the machine. DO NOT download any updates unless instructed to do so by Rottler.
- \_\_\_\_\_ Connect customer supplied Internet to the machine.
- \_\_\_\_\_ Verify that the Internet is accessible from the machine.
- \_\_\_\_\_ Explain to the customer how to properly turn the machine off when it is not in use. Do not leave the machine on overnight. It is important to close all programs followed by shutting down Windows before turning the main power switch off. Do not turn the main power switch off before shutting down Windows.
- \_\_\_\_\_ Using the operating manual as a guide explain the function of all buttons.
- \_\_\_\_\_ Cycle all machine movements and supervise the handling of same by operator.
- \_\_\_\_\_ Demonstrate the differences of Manual and Auto operation.
- \_\_\_\_\_ Explain machine parameters and error messages. It is very important that the customer does not change parameter settings without first checking with Rottler Manufacturing. If certain parameters are changed the machine may make uncontrolled moves or not operate at all.
- \_\_\_\_\_ Point out safety features to customer and operator. **Do not push any buttons without thinking of safety first.**

\_\_\_\_\_ The following is a checklist to go through every time the machine is started to begin a cut or automatic cycle.

- Work piece secure
- RPM set
- Feed Rate set
- Correct program in use
- Program oriented correctly (vertical zero at correct place) Guards in place
- Cutterhead secure
- Tool holder adjusted to the correct size
- Tool holder locked in place

\_\_\_\_\_ Parts ordering, refer the to the operating manual for part numbers and description.

\_\_\_\_\_ Review Emergency stop procedure with operator per operating manual.

## **MAINTENANCE SECTION**

\_\_\_\_\_ Use the manual as a reference when explaining routine maintenance and lubrication.

\_\_\_\_\_ Overload devices, There are no mechanical overload devices on this machine. The machine is protected from overload by the motor controllers. If the system is overloaded the controllers shut the motors off. The controllers can be reset by turning the main power off for at least 1 minute, then turning it back on.

Rottler Manufacturing and its employees or representatives are not responsible for any information regarding final specifications of any workpiece that is created as a final product when using Rottler equipment. It is the responsibility of the end user of Rottler equipment to determine the final dimensions and finishes of the workpiece that they are working on. Any information regarding final dimensions and finishes that appears in any Rottler literature or that is expressed by anyone representing Rottler is to be regarded as general information to help with the demonstration of or for operator training of Rottler equipment.

Note: Rotter employees and representatives per company policy are not permitted to provide end user of Rottler equipment with any OEM specifications for the workpiece that is created by end user using Rottler equipment.

General remarks on machine performance, adjustments as received and any further organization or parts required to complete the installation.

---



---



---



---



---



---



---



---



---



---



---



---



---



---



---



---



---



---



---



---



---



---

Instructions given to: \_\_\_\_\_

Sales/Service Engineer: \_\_\_\_\_ Date \_\_\_\_\_

Shop Foreman/Superintendent or Owner: \_\_\_\_\_ Date \_\_\_\_\_

**Once completed send this form to:  
Rottler Manufacturing  
attn: Service Manager  
8029 S 200 St  
Kent, WA 98032 USA**

**Alternately you may send this form via fax or e-mail:  
fax: [+1] 253-395-0230  
e-mail: service@rottermfg.com**

## Machine Dimensions

### Front Dimensions

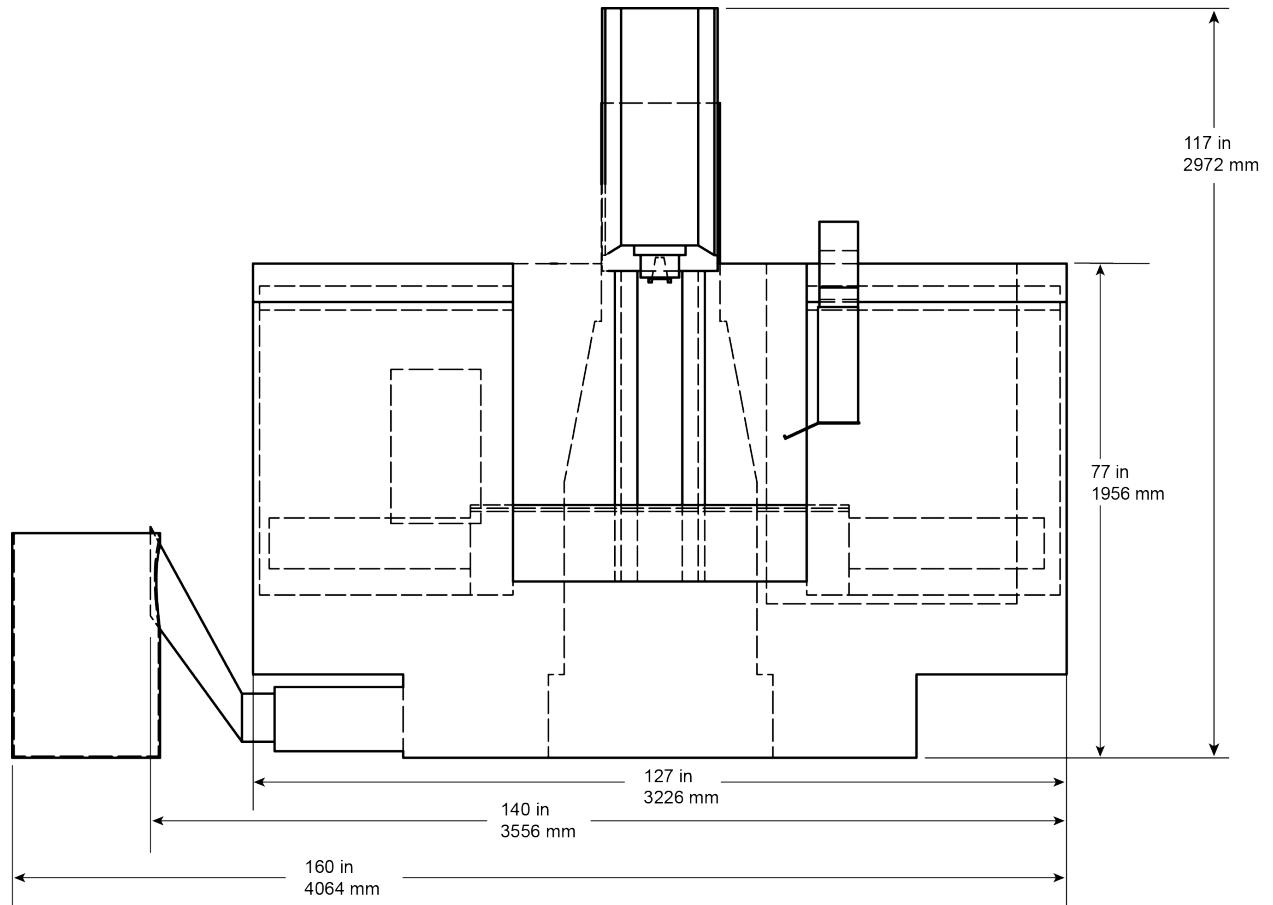



**Side Dimensions**

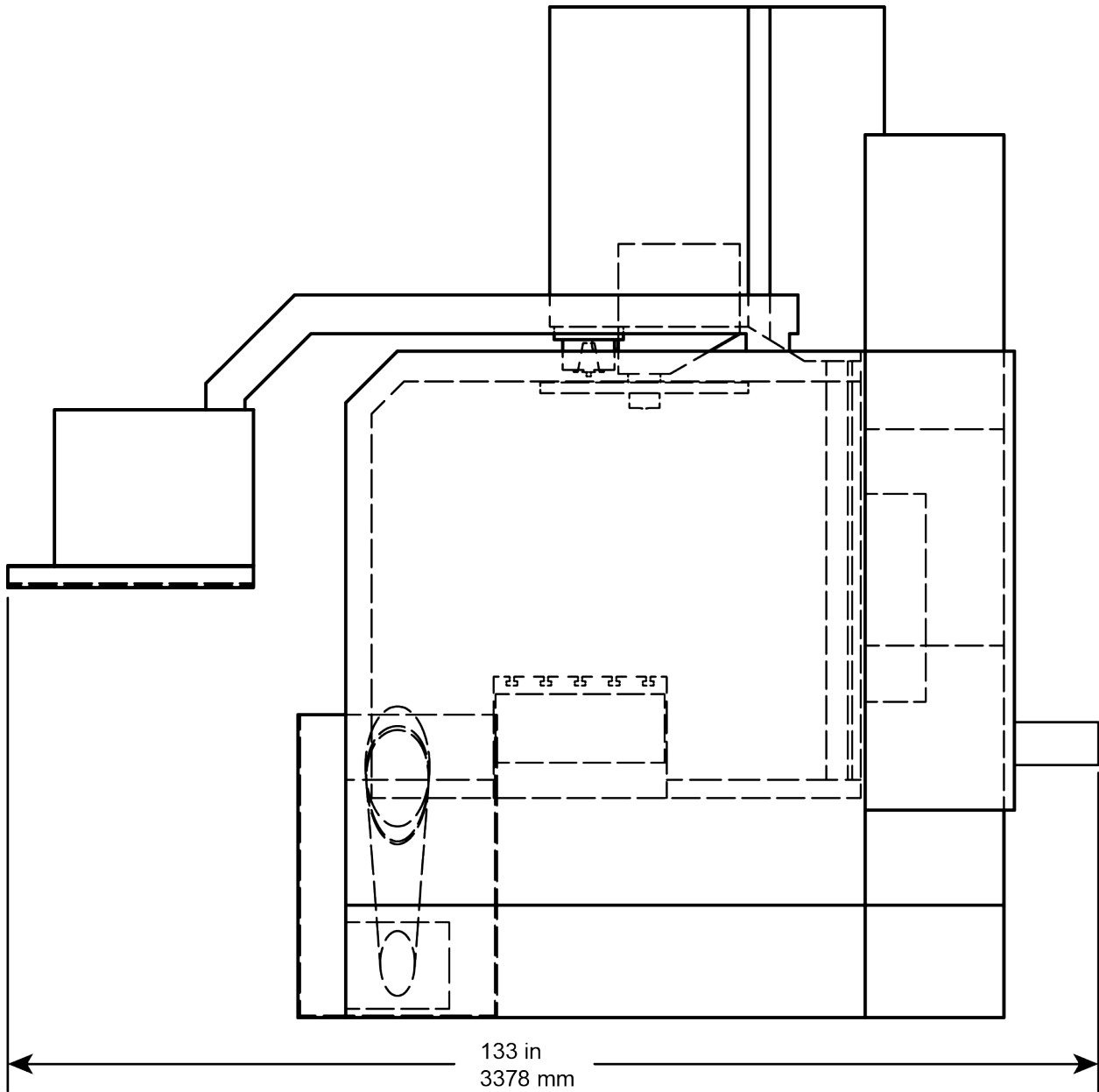

### Clearance Dimensions

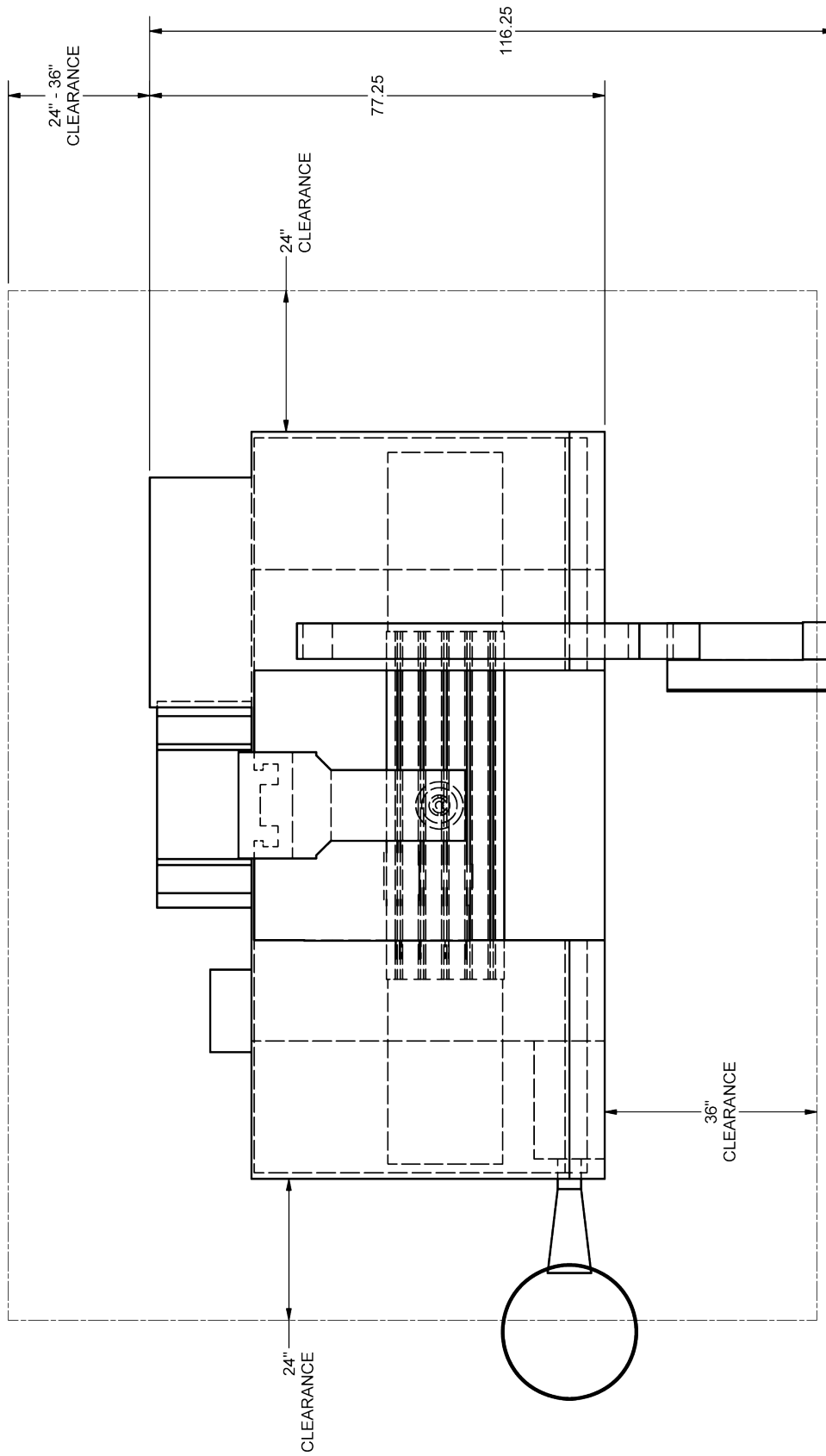

**Leveling Bolt Locations**

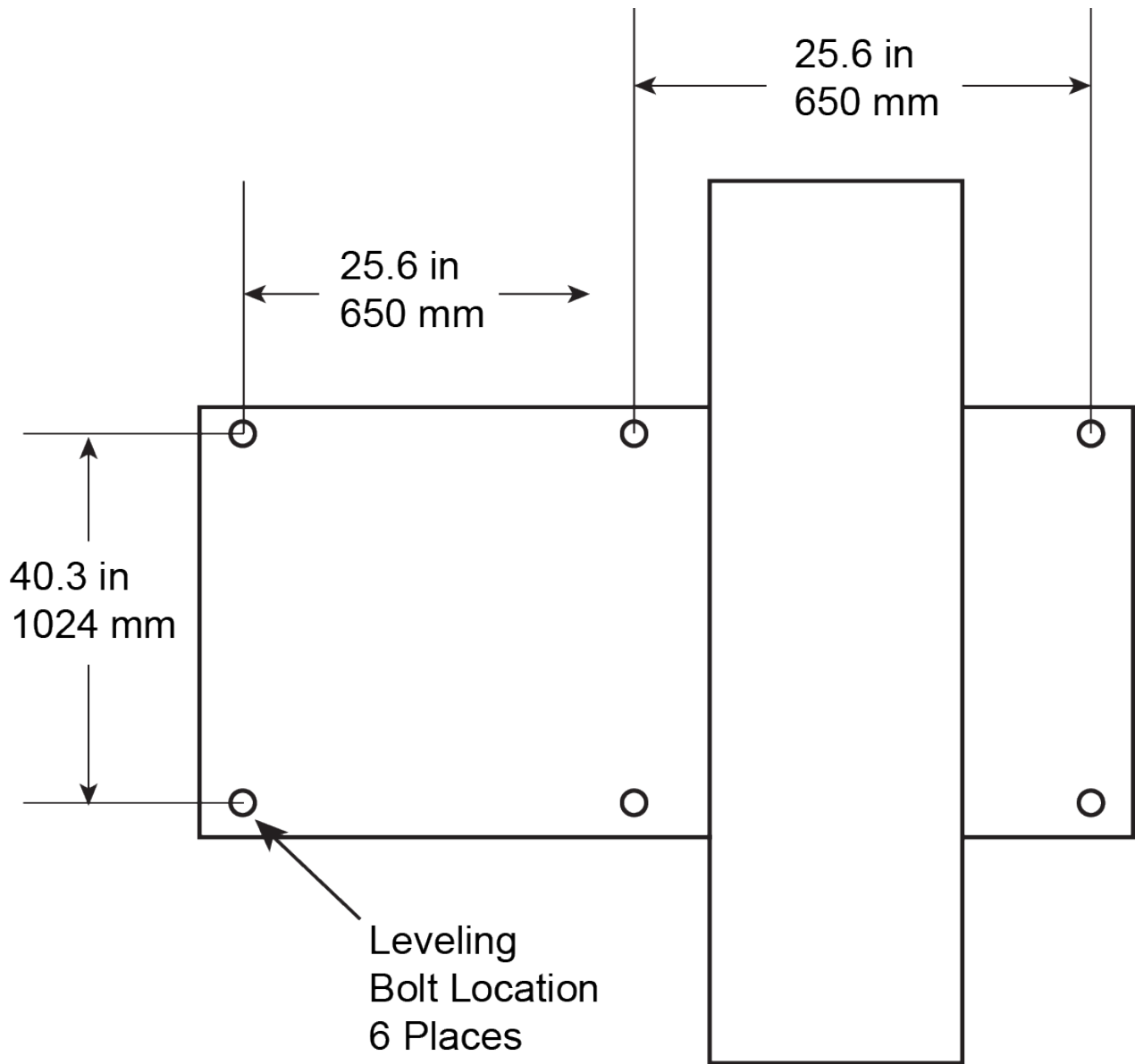

## Installation Procedure



### **IMPORTANT!** *Placement of Machine*

It is critical that the machine be placed in an area of the facility that has a stable thermal environment. The machine should be kept away from direct sunlight, large heating units, and doorways that would allow outside air direct contact on the machine.

Exposure to the above and other extremes in temperature will cause thermal drift to occur in the machines which could have a detrimental effect on machining accuracy. A number of unrepeatability errors in machine performance have been linked to this condition.

### **Location**

The productivity of the P69AHD will depend a great deal on the proper initial installation. Pay particular attention to the means by which work pieces are lifted into and out of the machine as well as the material handling to and from other operations in your shop. The proper loading arrangements and work location for your P69AHD is extremely important.

A slow travel (6' to 10' per minute) power hoist, operated from either a bridge or jib crane arrangement works very well. A 1000 lb. is generally adequate for lifting most engine blocks. An air hoist with speed control makes an ideal method for fast, efficient loading and unloading.

For shops where large production runs are anticipated, the work pieces should be loaded and unloaded directly from a conveyor. If this is not the case, we suggest you pay considerable attention to the crane so that it covers an adequate area to allow the operator to back up and remove work pieces without creating a cluttered, dangerous work area.

### **Unpacking and Lifting**

Use care when removing the crate materials from the machine. Be careful not to use force on any part of the machine.

## Power Supply

This machine has the following power requirements:

- 208 to 240 VAC
- Three Phase
- 50 or 60 Hertz
- 50 amps

See illustration for correct connection of “measured” incoming power. Connect three phase wiring to the power terminals located in the main rear enclosure, located on the right rear of machine base. The connection terminals are located on the DIN rail. Connect high leg of 3 phase power to L3 blue terminal. Attach other 2 power lines to terminal blocks L1 and L2. Attach wire from the grounding rod to the ground block.

( This illustration is for reference only. Actual location of components may be different. )

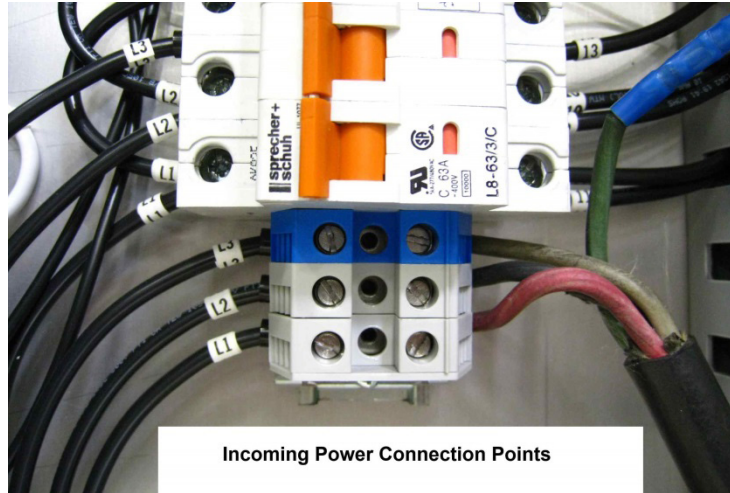

### **IMPORTANT**

*Electrically connect in accordance with national and local electrical codes.*

### Grounding

This machine must be connected to a good earth ground rod. A 6 foot, 1/2" diameter, 15 OHM, Copper grounding rod driven into the earth next to the machines is preferred. **Not providing a grounding rod could void factory warranty.**

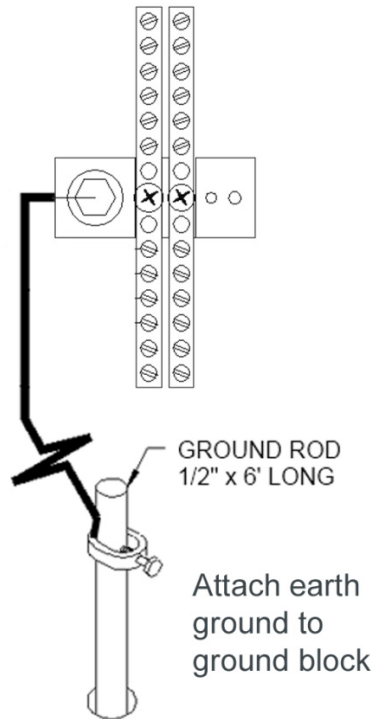
**IMPORTANT**

*Electrically connect in accordance with national and local electrical codes.*

## Creating a Skype Account

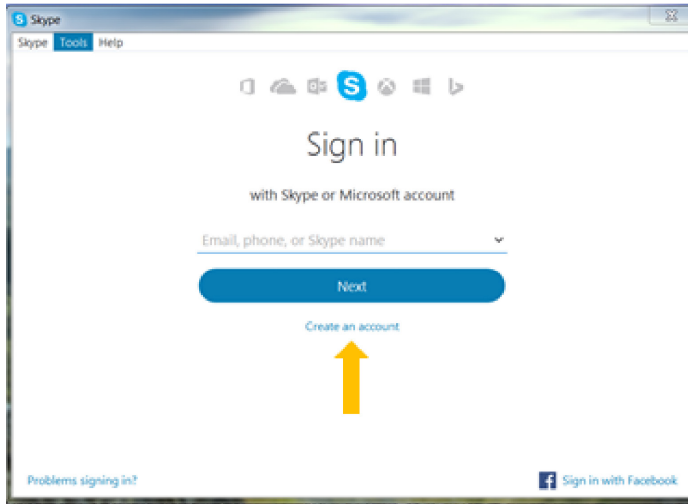

Click on create an account

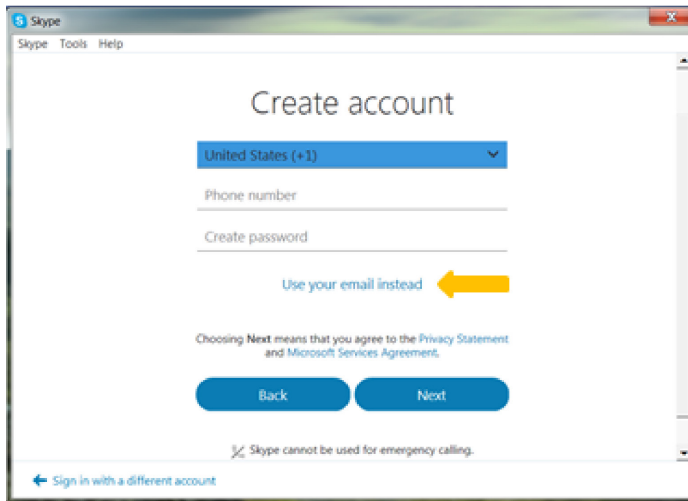

Click on: Use your email instead

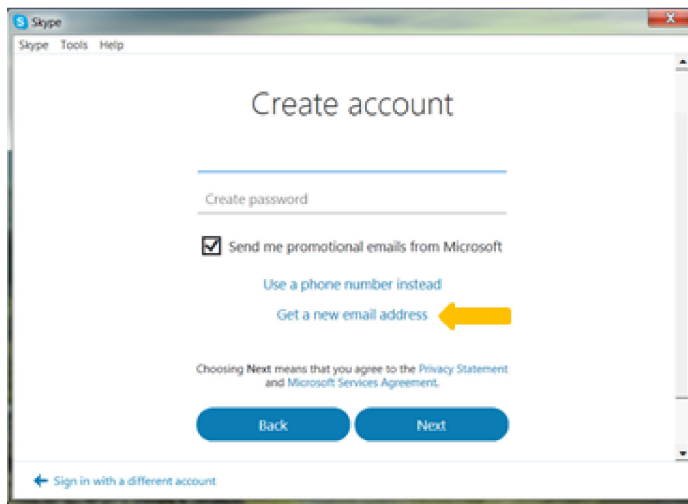

Click on: Get new email address

Skype  
Skype Tools Help

## Create account

ModelSerialNumber @outlook.com

Create password

Send me promotional emails from Microsoft

Use a phone number instead  
Use your email instead

Choosing Next means that you agree to the Privacy Statement and Microsoft Services Agreement.

Back Next

← Sign in with a different account

Name the email account using the Rottler machine Model and Serial number.

Ex: H85A111, EM69P001

Create a password that is easy to remember.

**Uncheck** the box to receive emails from Microsoft.

Skype  
Skype Tools Help

## Add details

We need a little more info before you can use this app.

Model-SerialNumber

RottlerMfg

Back Next

Skype cannot be used for emergency calling.  
Microsoft

← Sign in with a different account

First Name: Model-Serial Number

Ex: H85A-111, EM69P-001

Last Name: RottlerMfg

Skype  
Skype Tools Help

## Add details

We need a little more info before you can use this app.

Country/region  
United States

Birthdate  
January 31 1992

Back Next

Skype cannot be used for emergency calling.  
Microsoft

← Sign in with a different account

Select your Country/region

Birthday: Today's date, year 1992



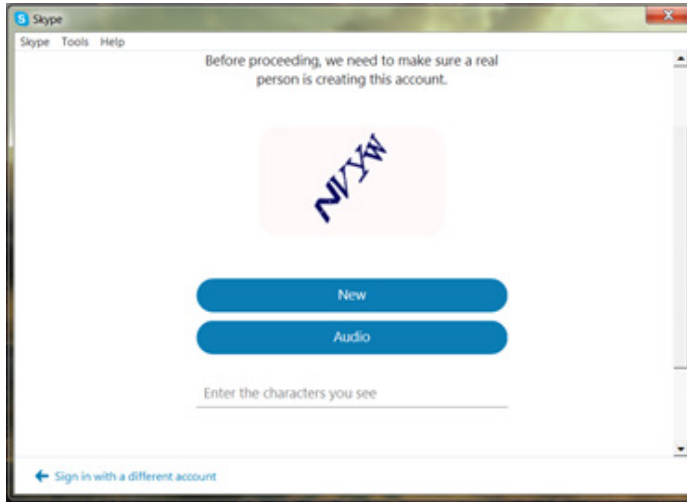

Type the code exactly as it appears.

Click "Next"

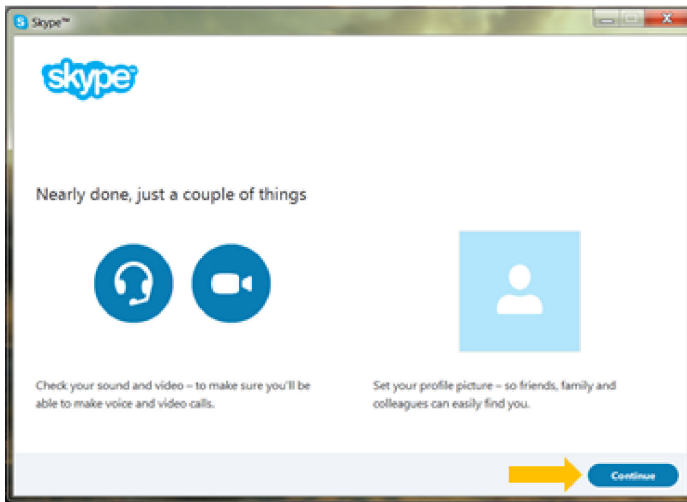

Click "Continue"

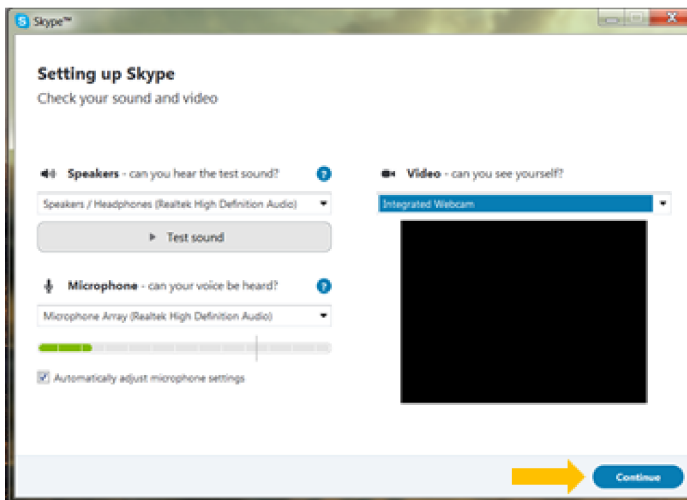

If your headset and/or web camera are hooked up you can verify that they are working here.

Otherwise, click "Continue"

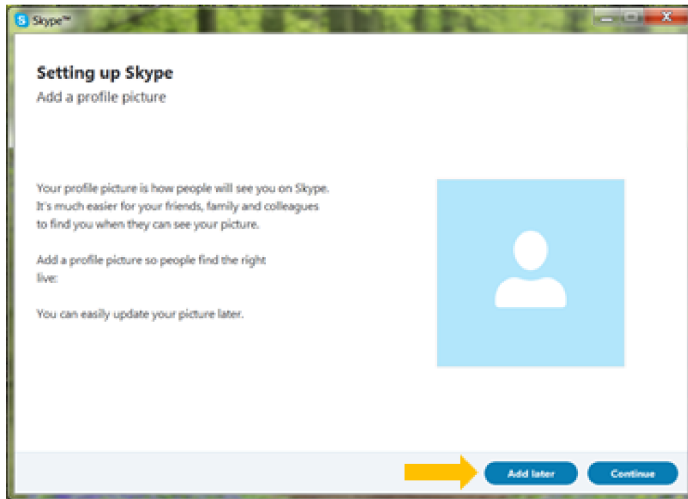

Click "Add later" to skip this part.

Your Skype account is set up and ready for use.

This page intentionally left blank

# **SAFETY**

## **Contents**

<b>Safety Information .....</b>	<b>3-1</b>
<b>Safety Instructions for Machine Use .....</b>	<b>3-1</b>
<b>Electrical Power .....</b>	<b>3-3</b>
<b>Machine Operator .....</b>	<b>3-5</b>
<b>Emergency Procedure .....</b>	<b>3-6</b>
<b>Computer and Controller System Safety .....</b>	<b>3-6</b>
<b>Electrical Safety Features Of Rottler DM Controlled Machines .....</b>	<b>3-7</b>

## Safety Information

For Your Own Safety Read This Instruction Manual Before Operating This Machine.

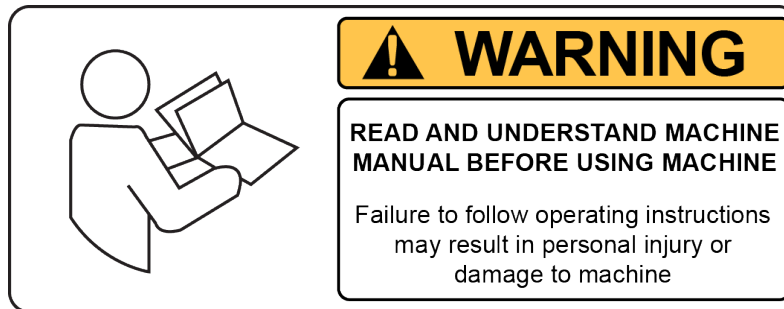

This is the safety alert symbol. It is used to alert you to potential personal injury hazards. Obey all safety messages that follow this symbol to avoid possible injury or death.



**DANGER** indicates an imminently hazardous situation which, if not avoided, will result in death or serious injury.



**WARNING** indicates a potentially hazardous situation which, if not avoided, could result in serious injury.



**CAUTION** indicates a potentially hazardous situation which, if not avoided, may result in minor or moderate injury.



**CAUTION** used without the safety alert symbol indicates a potentially hazardous situation which, if not avoided, may result in property damage.

### Safety Instructions for Machine Use



**This machine is capable of causing severe bodily injury**

**ONLY A QUALIFIED, EXPERIENCED OPERATOR SHOULD OPERATE THIS MACHINE. NEVER ALLOW UNSUPERVISED OR UNTRAINED PERSONNEL TO OPERATE THE MACHINE.** Make sure any instructions you give in regards to machine operation are approved, correct, safe, and clearly understood. Untrained personal present a hazard to themselves and the machine. Improper operation will void the warranty.

**KEEP GUARDS IN PLACE** and in proper working order. If equipped with doors, they must be in the closed position when the machine is in operation.



**KEEP WORK AREA CLEAN.** Cluttered areas and benches invite accidents.

**KEEP CHILDREN AND VISITORS AWAY.** All children and visitors should be kept a safe distance from work area.

**WEAR THE PROPER APPAREL.** **DO NOT** wear loose clothing, gloves, rings, bracelets, or other jewelry which may get caught in moving parts. Non-Slip foot wear is recommended. Wear protective hair covering to contain long hair.

**ALWAYS USE SAFETY GLASSES.** Also use face or dust mask if cutting operation is dusty. Everyday eye glasses only have impact resistant lenses, they are NOT safety glasses.



**DO NOT OVER-REACH.** Keep proper footing and balance at all times.

**USE THE RECOMMENDED ACCESSORIES.** Consult the manual for recommended accessories. The use of improper accessories may cause risk of injury.

**CHECK DAMAGED PARTS.** Before further use of the machine, a guard or other part that is damaged should be checked to determine that it will operate properly and perform its intended function. Check for alignment of moving parts, breakage of parts, mounting, and other conditions that may affect its operation. A guard or other part that is damaged should be properly repaired or replaced.

**NEVER OPERATE A MACHINE WHEN TIRED, OR UNDER THE INFLUENCE OF DRUGS OR ALCOHOL.** Full mental alertness is required at all times when running a machine.

**IF AT ANY TIME YOU ARE EXPERIENCING DIFFICULTIES** performing the intended operation, stop using the machine! Then contact our service department or ask a qualified expert how the operation should be performed.

**DO NOT MODIFY OR ALTER THIS EQUIPMENT** in any way. If modifications are deemed necessary, all such requests must be approved and/or handled by Rottler Manufacturing. Unauthorized modifications could cause injury and/or damage to machine and will void the warranty.

**SAFETY DECALS SHOULD NEVER BE REMOVED.** They are there to convey important safety information and warn of potential hazards.

**ALL LOCAL SAFETY CODES AND REGULATIONS** should be followed when installing this machine.

**ONLY QUALIFIED PERSONAL** should perform service on the electrical and control systems.

When boring the machine is capable of throwing metal chips over 10- feet from the cutting area. Always use the guards. Eye protection must be worn at all times by the operator and all other personnel in the area of the machine.



**CAUTION** No list of safety guidelines can be complete. Every piece of shop environment is different. Always consider safety first, as it applies to your individual working conditions. Use this and other machinery with caution and respect. Failure to follow guidelines could result in serious personal injury, damage to equipment or poor work results.

### Electrical Power

**THIS MACHINE IS AUTOMATICALLY CONTROLLED AND MAY START AT ANYTIME**

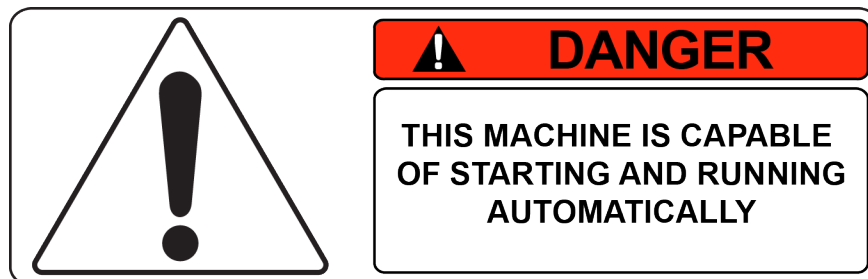

All electrical power should be removed from the machine before opening the rear electrical enclosure.

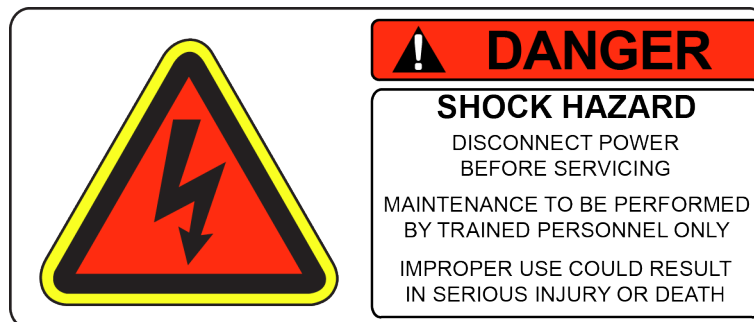

In the event of an electrical short, grounding reduces the risk of electric shock by providing a path of least resistance to disperse electric current.

Electrocution or a fire can result if the machine is not grounded correctly. Make sure the ground is connected in accordance with this manual. DO NOT operate the machine if it is not grounded.

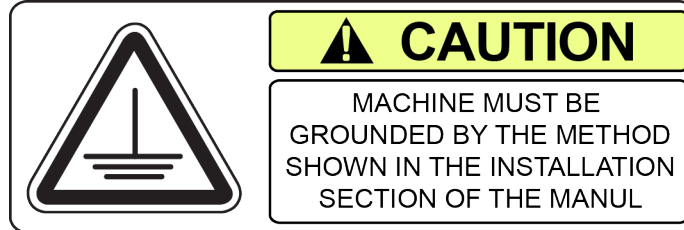

**CAUTION** No single list of electrical guidelines can be comprehensive for all shop environments. Operating this machinery may require additional electrical upgrades specific to your shop environment. It is your responsibility to make sure your electrical system comply with all local codes and ordinances.

**WARNING** This machine operates under computerized control and, as is all computerized equipment, and is susceptible to extraneous electrical impulses internally for externally produced. The machine may make moves out of the operator control at any time. The operator should work in and around the machine with caution at all times.

The operator and nearby personnel should be familiar with the location and operation of the Emergency Stop Button.

Make sure all electrical equipment has the proper overload protection. This machine should have **a fully isolated** power supply to prevent damage and uncontrolled movement of the machine. If this machine is on the same power lines that are running to other electrical equipment (grinders, welders, and other AC motors) electrical noise can be induced into this machines electrical system. Electrical noise can cause the controller to see false signals to move. Not supplying a fully isolated supply to the machine may void factory warranty. Refer to the Power supply section located in the Installation section for voltage and amperage requirements of this machine.



## Machine Operator

The operator of this machine should be a skilled machinist craftsman who is well versed in the caution, care, and knowledge required to safely operate metal cutting tools.

If the operator is not a skilled machinist he/she must pay strict attention to the Operating Instructions outlined in this manual, and get instruction from a qualified machinist in both production and operation of this machine.

This machine has the following areas of exposed moving parts that you must train yourself to respect and stay away from when they are in motion:

**Cutting Tool Area** – Any operation involving hands in the cutter head area, such as inspection or alignment of the cutter head or tools, changing Centering Fingers, tool insertion, and removal, cutter head changes, and size checking etc. requires the machine to be in Neutral.

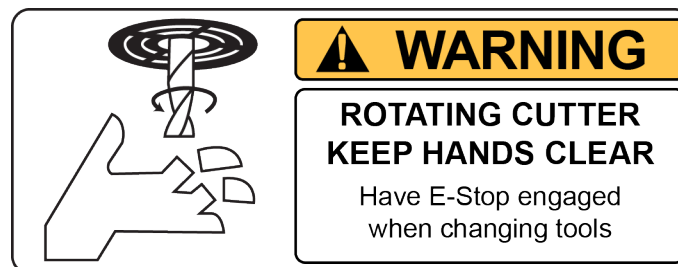

**Machining** – Eye protection must be worn during all operations of the machine. Hands must be kept completely away from the cutter head. All chip guards must be in position during machine operations.



**CAUTION** **Work Loading and Unloading** – Carefully develop handling methods of loading and unloading work pieces so that no injury can result if hoist equipment or lift connection should fail. Periodically check lift components for damage that may cause failure.

**CAUTION** **Machine Maintenance** – Any machine adjustment, maintenance or parts replacement absolutely requires a complete power disconnection from the machine.

## Emergency Procedure

Assuming one of the following has occurred: tool bit set completely off size, work piece or spindle base not clamped, spindle is not properly centered, and these mistakes will become obvious the minute the cut starts

**PRESS THE EMERGENCY STOP BUTTON** (on the front control panel) **IMMEDIATELY!**

Find out what the problem is; return the spindle to its up position without causing more damage. To restart the machine, turn the Emergency Stop Button CW until the button pops out

Be alert to quickly stop the machine in the event of a serious disruption of the boring process either at the top or bottom of the bores.

**“REMEMBER”** metal cutting tools have the speed and torque to severely injure any part of the human body exposed to them.

## Computer and Controller System Safety

The computer and controller are located in the main rear electrical enclosure. This unit is a full computer, running Windows 7 64 Bit operating system. Contact the factory if more information on the computer system is required.

**IMPORTANT** The computer in this machine has the ability to connect to the World Wide Web via Ethernet or Wireless using a USB wireless (Wi-Fi) adapter. Updating the Rottler software should **ONLY** be done when directed to do so by a Rottler service technician. Updating Rottler Software when not directed by Rottler personnel will result in a non-operational machine.

The machine should be hooked up to the Internet anytime it is on. The software on the machine will automatically connect to our server to send back useful information on machine status.

Any “IT” personnel should **ALWAYS** get approval from Rottler before doing **ANYTHING** on the computer.

**! DANGER** This machine is capable of causing severe injury or death. Doing any of the following without Rottler’s direct consent may cause severe injury or death.

**! WARNING** Do not attempt to install USB devices in the PCI ports. These ports have high voltage and any attempt to connect a USB device in these ports will result in destruction of that device. There is also the possibility of damage to the computer system of the machine.



**IMPORTANT** Downloading any program or changing any Rottler or Computer settings may cause the machine and/or software to become unstable. **DO NOT** install ANY screen saver, Anti-Virus, Spyware or any type of Security software on the computer. This could create a hazardous environment for the operator and personnel around the machine. Performing any of the above will also result in the machine warranty being NULL and VOID.

**IMPORTANT** **DO NOT** connect any type of external hardware to the computer via USB or any other means. Do not install any type of Device Driver. This could create a hazardous environment for the operator and personnel around the machine. Performing any of the above will also result in the machine warranty being NULL and VOID.

## **Electrical Safety Features Of Rottler DM Controlled Machines**

All Rottler machines that use the DM operational control system are designed to comply with all applicable safety standards. This includes but is not limited to the following systems:

Thermal sensors in all motors and motor controls.

1. Current sensors in all motor control panels.
2. Electrical breakers to prevent voltage surges and spikes from reaching electrical system.
3. Electrical lockout on main electrical enclosure.
4. E-Stop that shuts down all operational systems in an event of an emergency.

All thermal and current limits for motors and motor controls are preset at the factory. In the event that any of those parameters are exceeded during operation of the machine, the machine control system will shut down the machine and a warning of the specific fault will appear on the control screen.

# CONTROL DEFINITIONS

## Contents

<b>Control Definitions .....</b>	<b>4-1</b>
<b>Computer and Controller System Safety .....</b>	<b>4-1</b>
<b>Master Power On/Off Switch .....</b>	<b>4-2</b>
<b>Machine Startup.....</b>	<b>4-3</b>
<b>E-Stop .....</b>	<b>4-3</b>
<b>Homing the Machine .....</b>	<b>4-3</b>
<b>Control.....</b>	<b>4-3</b>

## Control Definitions

The purpose of this chapter is to define the function of the buttons throughout the various screens. Certain button functions may not make sense right away in this chapter. As the operator reads through the Operating Instructions chapter of this manual, the function of these buttons will become clear.

### Computer and Controller System Safety

The computer and controller are located in the main rear electrical enclosure. This unit is a full computer, running Windows 7 64 Bit operating system. Contact the factory if more information on the computer system is required.

**IMPORTANT:** The computer in this machine has the ability to connect to the World Wide Web via Ethernet or Wireless using a USB wireless adapter. This machine should NOT be connected to the Internet for any reason other than getting a software update. This should ONLY be done when directed to do so by a Rottler service technician. Updating Rottler Software when not directed by Rottler personnel will result in a non-operational machine.

Any "IT" personnel should ALWAYS get approval from Rottler before doing ANYTHING on the computer.



This machine is capable of causing severe injury or death. Doing any of the following without Rottler's direct consent may cause severe injury or death.



Connecting to the Internet for any other reason will leave the machine vulnerable to viruses which could create a safety hazard and/or leave the machine inoperable.



Downloading ANY program from the Internet or by other means when not directed by Rottler is prohibited and will result in the machine warranty being NULL and VOID.



Downloading any program or changing any Rottler or Computer settings may cause the machine and/or software to become unstable. DO NOT install ANY screen saver, Anti-Virus, Spyware or any type of Security software on the computer. This could create a hazardous environment for the operator and personnel around the machine. Performing any of the above will also result in the machine warranty being NULL and VOID.



DO NOT connect any type of external hardware to the computer via USB or any other means. Do not install any type of Device Driver. This could create a hazardous environment for the operator and personnel around the machine. Performing any of the above will also result in the machine warranty being NULL and VOID.

### **Master Power On/Off Switch**

This switch is located on the main electrical control enclosure on the right hand side of the machine. The switch must be in the off position before opening the rear enclosure door.

When first applying power to the machine the computer will need to boot up. Be patient, it will take several minutes to complete booting. The Rottler program will not automatically start. Double tap the Rottler\_WPF icon on the screen to start Rottler.

When turning the main power to the machine off there is a specific procedure to follow so as not to damage the computer. The computer must shut down its internal systems before main power is removed from it.

Press the "Start" button in the left-hand side of the Start Bar. This will bring up the "Start Menu". Press the "Shutdown" line at the bottom of the Start Menu. This will bring up a Pop Up menu, make sure that "shut down computer" is selected and press "OK".

This will shut down the computer. It is now OK to turn Main Power off to the machine.

## Machine Startup

Start by double clicking the direct surface icon found on your desktop.

## E-Stop

The E-stop is a safety tool that will prevent the machine from moving and allow you to immediately terminate any action that the machine is performing, in case there is an emergency. Once the Direct Surface program has opened, twist the red E-stop button until it pops out.

## Homing the Machine

Every time a new session of Direct Surface has been opened the machine MUST be homed to ensure proper operation the machine. This allows the machine to accurately locate all travel limits and zeros. To home the machine you click the green "Home" button on the right side of the screen. The A and B axis will rotate to a specified 'home' location. Once this process is complete, a message saying "Homing Complete" will appear and you may click "OK." If you receive a message that says "Error: Move Axis farther away from homing switch" The just use the green jog buttons to move the mentioned axis and press the "HOME" button again.



(You will see this message after all axes find their limits.)

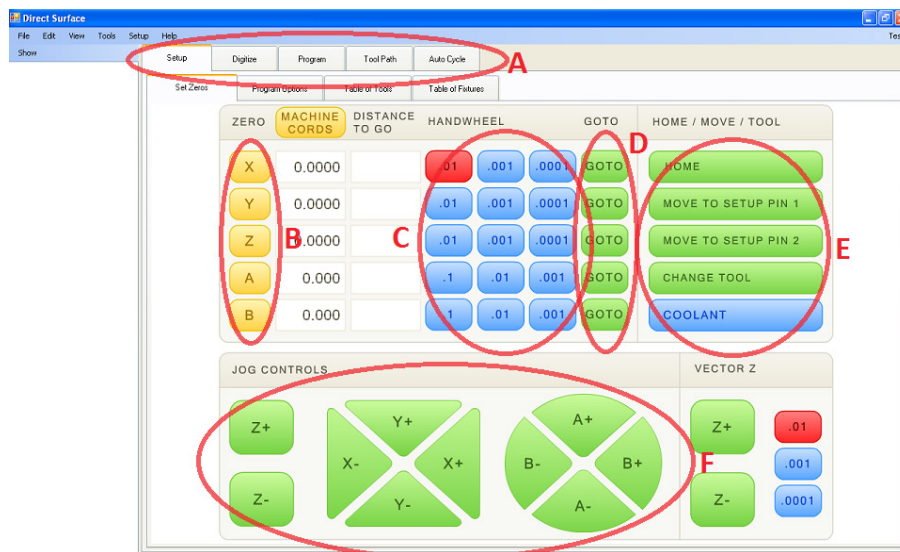

## Control

Viewing the control there are several tabs to click on (A) which include Setup, Digitize, Program, Tool path, and Auto Cycle. Each of these tabs will be used in order to guide you through the programming process. The yellow X, Y, Z, A, B buttons (B) allow you to zero you fixture coordinates. The blue "HANDWHEEL" buttons (C) are to select the increments you would like to move each axis by the hand wheel. The "GOTO" buttons (D) allow you to quickly move to a designated fixture location. The green buttons in E allow you to perform essential setup functions. The "JOG CONTROLS" (F) allow you to quickly move the machine in less precise increments to a desired location.

# OPERATING INSTRUCTIONS

## Contents

<b>OPERATING INSTRUCTIONS .....</b>	<b>5-1</b>
Spindle Chiller System.....	5-1
Spindle Warm Up/Break In.....	5-2
<b>MACHINE STARTUP .....</b>	<b>5-2</b>
Home Machine .....	5-2
Control Interface.....	5-3
<b>MACHINE SETUP .....</b>	<b>5-4</b>
Fixture Set UP .....	5-4
Locating Fixture.....	5-5
Defining Tool Length and Probe Length Offsets.....	5-7
Probe Length .....	5-7
Table of Tools.....	5-8
<b>DIGITIZING .....</b>	<b>5-10</b>
Starting a New Head.....	5-10
Creating a Port.....	5-11
Digitizing a Port .....	5-12
Creating Planes .....	5-13
<b>PLANE #1 .....</b>	<b>5-13</b>
<b>PLANE #2 .....</b>	<b>5-17</b>
<b>PLANE #3 .....</b>	<b>5-19</b>
Creating Intersecting Planes .....	5-20
Probing Defined Planes .....	5-24
Cross-Section Manipulation .....	5-27
Creating a Surface.....	5-28



<b>Surface Manipulation .....</b>	<b>5-29</b>
<b>Creating a Toolpath .....</b>	<b>5-29</b>
<b>Creating a Roughing Routine for The Toolpath.....</b>	<b>5-31</b>
<b>Moving Pivot Points .....</b>	<b>5-32</b>
<b>Loading and Running a Tool Path .....</b>	<b>5-34</b>
<b>Creating A Combustion Chamber .....</b>	<b>5-37</b>
<b>Adding Planes.....</b>	<b>5-38</b>
<b>Defining the Planes .....</b>	<b>5-39</b>
<b>Defining Deck Plane .....</b>	<b>5-40</b>
<b>First Plane.....</b>	<b>5-40</b>
<b>Second Plane .....</b>	<b>5-41</b>
<b>Moving Deck Surface .....</b>	<b>5-43</b>
<b>Create Cross Sections .....</b>	<b>5-44</b>
<b>Inside Border .....</b>	<b>5-45</b>
<b>Creating a Tool Path.....</b>	<b>5-51</b>
<b>Mirroring.....</b>	<b>5-53</b>
<b>Mirroring Tool Path .....</b>	<b>5-53</b>
<b>Backing Up and Restoring Block Profiles.....</b>	<b>5-54</b>
<b>Backing Up and Restoring RCam Programs .....</b>	<b>5-61</b>
<b>Backing Up and Restoring RCam Tables .....</b>	<b>5-69</b>
<b>Backing Up and Restoring Porting Programs .....</b>	<b>5-77</b>
<b>Using 3rd Party Tooling in Rottler Machines with CAT 40 Tooling.....</b>	<b>5-85</b>

## OPERATING INSTRUCTIONS

### Spindle Chiller System

The spindle chiller system **MUST** be on whenever the machine is operating. The chiller is turned on separately from the machine. Before proceeding you should check to make sure it is operating. The display should read a number representing a degree in Celsius. You can toggle between room and oil temperature by pressing the "ON/OFF" button.

To change the temperature settings of the chiller system, simply hold one of the "UP" or "DOWN" arrows on the control panel for 3 seconds. This will cause the number on the screen to change to a number "+15.0/-15.0." These numbers represent the desired temperature of the oil as compared to room temperature. The recommended settings are "-3.0" for room temperatures 20+ degrees Celsius and "+3.0" for room temperatures 19.5- degrees Celsius.

#### Chiller Control Panel

The green lights on the left hand side (A) indicate whether the number displayed is room or oil temperature. The number displayed (B) is a Celsius reading of temperature. The "UP" and "DOWN" arrows (C) allow you to change temperature settings in the oil chiller. The "ON/OFF" button (D) will toggle the temperature selection between oil and room temperature.

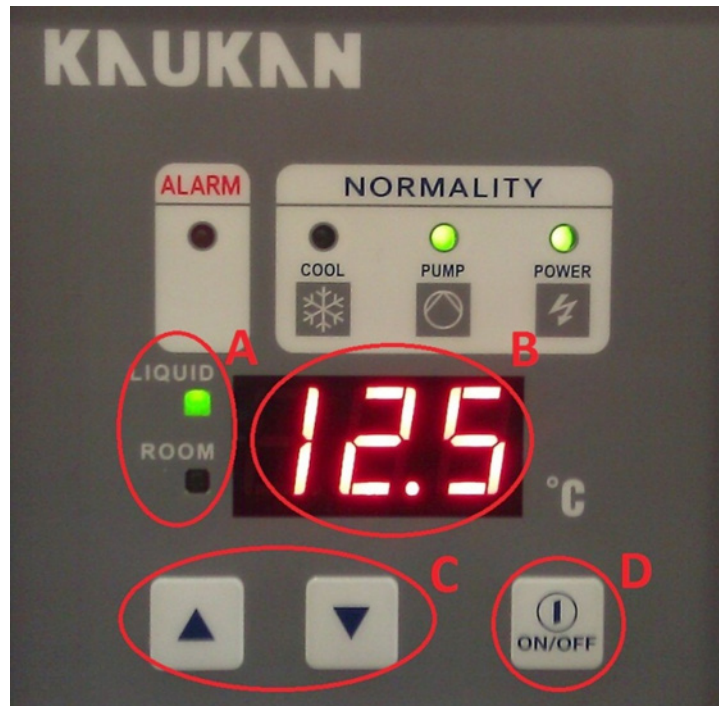

## Spindle Warm Up/Break In

It is imperative that the spindle motor is warmed up before any cutting is done to prevent permanent damage to the internal components. There are two cycles that can be run to accomplish this. The first and most common cycle is the “Quick Warm Up” cycle. This cycle takes approximately 30 minutes to complete. The Quick Warm Up should be done any time the machine has sat in without the spindle running for 8 hours or more. The second cycle is the “Long Break In” cycle. This should be used any time the machine has been transported, the spindle has been left at a high angle overnight, or the spindle has not been operated in 7 days or more. This cycle takes approximately 2.5 hours. Both processes should be completed with the B axis at 0 degrees. There is no need to supervise the machine while it is operating in either of these modes.



***Do not perform the Warm Up/Break In procedure with any tooling attached to the spindle.***

## MACHINE STARTUP



- Start by double clicking the direct surface icon found on your desktop.
- Before operating the machine the operator needs to verify that the machine has the specified air supply pressure needed to run the machine.
- Open the rear air controls enclosure to view regulator pressure.
- Manifold gauges should read; 100psi, 35psi, 12psi.
- Note the middle gauge is the one that regulates the pressure for the B axis. This setting is critical.
- Not having the specific air pressure to the machine will cause the B axis to fall when tilted at an angle and motor loses power, the support cylinder will not have the air to prevent from the motor from falling. If there is too much air in the system it will cause the head to rise up when the head is tilted and the motor loses power.
- If pressure is not to spec, follow the B-Axis air pressure adjustment procedure located in the maintenance section of this manual.

## Home Machine

Once you are viewing the control click the HOME button. The machine will then proceed to home itself. You should then see a message that says “Homing Complete” like seen below. It may take a few seconds for the message to appear. Then click ‘OK’. (Make sure that the e- stop has been pulled out before homing machine).

You are now free to jog the machine around using the hand-wheel or the jog controls. The hand-wheel buttons are blue. To rapid X,Y,Z,A, and B around, click on the green “jog control” buttons as shown below. The yellow buttons are for zeroing either the machine origin or a fixture offset. If you mistakenly click on a zeroing button a question will appear allowing you to cancel the procedure. You should home the machine any time you begin a new session of Direct Surface.



(You will see this message after “Homing” is complete.)

## Control Interface

Viewing the control there are several tabs to click on which include Setup, Digitize, Program, Tool path, and Auto Cycle. Each of these tabs will be used in order to guide you through the programming process. You will start at the Setup tab and end with the Auto Cycle tab which will start your program when all of the variables have been entered. Each of these functions will all be discussed as we proceed through the software.



## MACHINE SETUP

### Fixture Set UP

Mount Fixture with the notched pin to the right of the operator, facing towards the tail stock, and closed pin towards the head stock. Some fixtures will have the locating pins on either the front or the back of the plate. You must mount the plate on the 2.0" side of the A axis rotating plate. (A axis should be at 0°) Please note that one side of the 4th axis from center is 2.0" and the other is 2.5". The 2.5" side will be used to touch off tools and probe which we will cover later. Four 1/2-13 bolts are to be used to fasten the head and fixture plate the 4th axis head and tail stock. Align dowel pins with an indicator as indicated by the red arrows below by tapping fixture plate to align pins with one another to be within .0001 in the Y axis, then tighten down to secure fixture to the head and tail stock.

If you are running multiple heads that are the same, leave fixture bolted to 4th axis unit and simply remove machined head, then simply bolt up the next head using the dowel pins for location and your origin and alignment will be exactly the same.



Each head will have its own specific offset. Notice the "Table of Fixtures" below. Each fixture number has a unique fixture name (i.e. fixture 1 is the Big Block Chevy fixture offset location). This will be defined as a fixture offset location.

The offset page can be found by picking the 'Setup' tab and under this tab you will see the 'Table of Fixtures' tab.

To choose the table of fixture you want use simply select the fixture number and it will be highlighted, then click on the 'Set Active' button on the right side of the screen. To add a new fixture simply click the 'Add New' button, then you can double click on the fixture number to change the name for the fixture.

## Locating Fixture

To locate fixture, the pins need to be located individually and set as a location within the program. Starting with the left side, use a dial indicator to locate the pin, the spindle will be in line with the pin and the indicator should be zero on the X and Y axis. Under the “Set UP” tab there’s a “Program Options” tab, then press the green button “Assign Pin Location 1” for the left pin. A window will come up asking if you are sure you want to set pin location and verifying that the right fixture number is selected. Then move to locate the pin on the right side, when centered on the pin go back to the “Program Options” and click on the green button “Assign Pin Location 2”

Pin one on the left will be used as the X and Y zero for the fixture offset location. All probe points as well as tool path information will be referenced from this pin location.

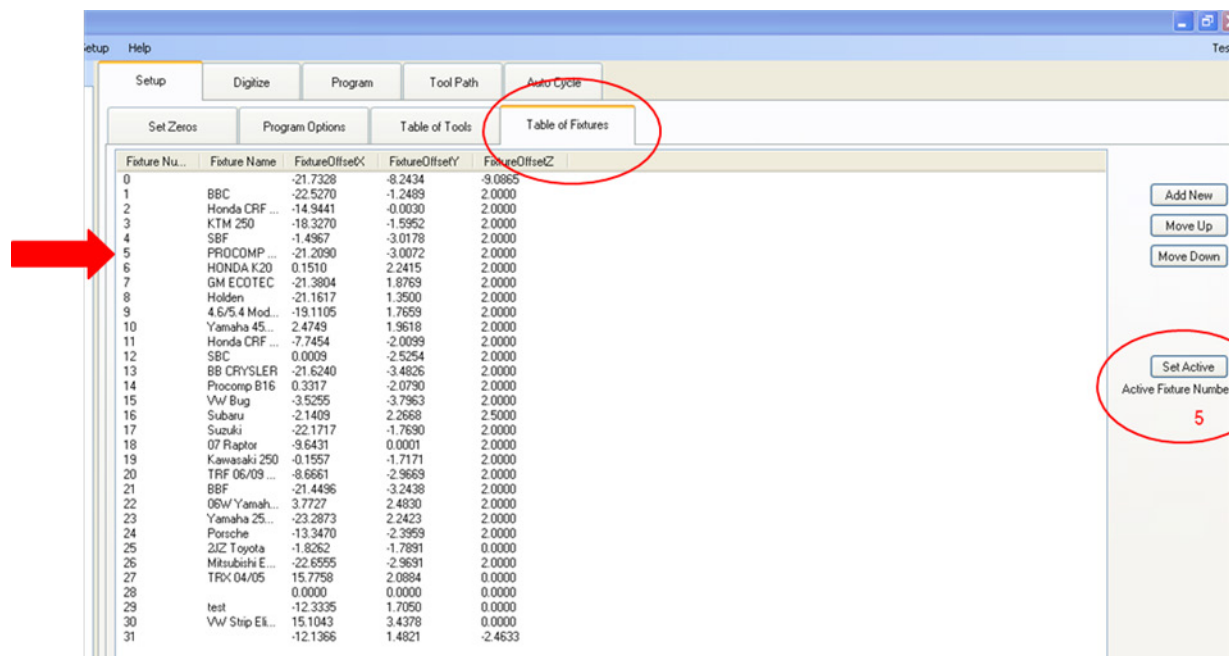

After both pins are located, the Z axis needs to be changed to 2.0000” since it’s the distance from what the fixture is rotating on the A axis. Simply go to the “Table of Fixtures” tab and click on the fixture number that is selected, there will be a window that come up indicating the position for the X, Y, and Z axis, double click on the Z axis and change it to 2.0000” and the fixture is set.



The yellow buttons on the “set Up” tab are for showing the “Fixture cords” and the “Machine Cords” you can toggle the same button to show either one. “Fixture Offset” is the distance away from what was set in reference to Pin number 1 and the Z location of the fixture. “Machine Cords” are set during the alignment procedure and is the distance from the Home Preset for each Axis. (these should not be changed or zeroed unless told to do so otherwise by a Rottler technician)

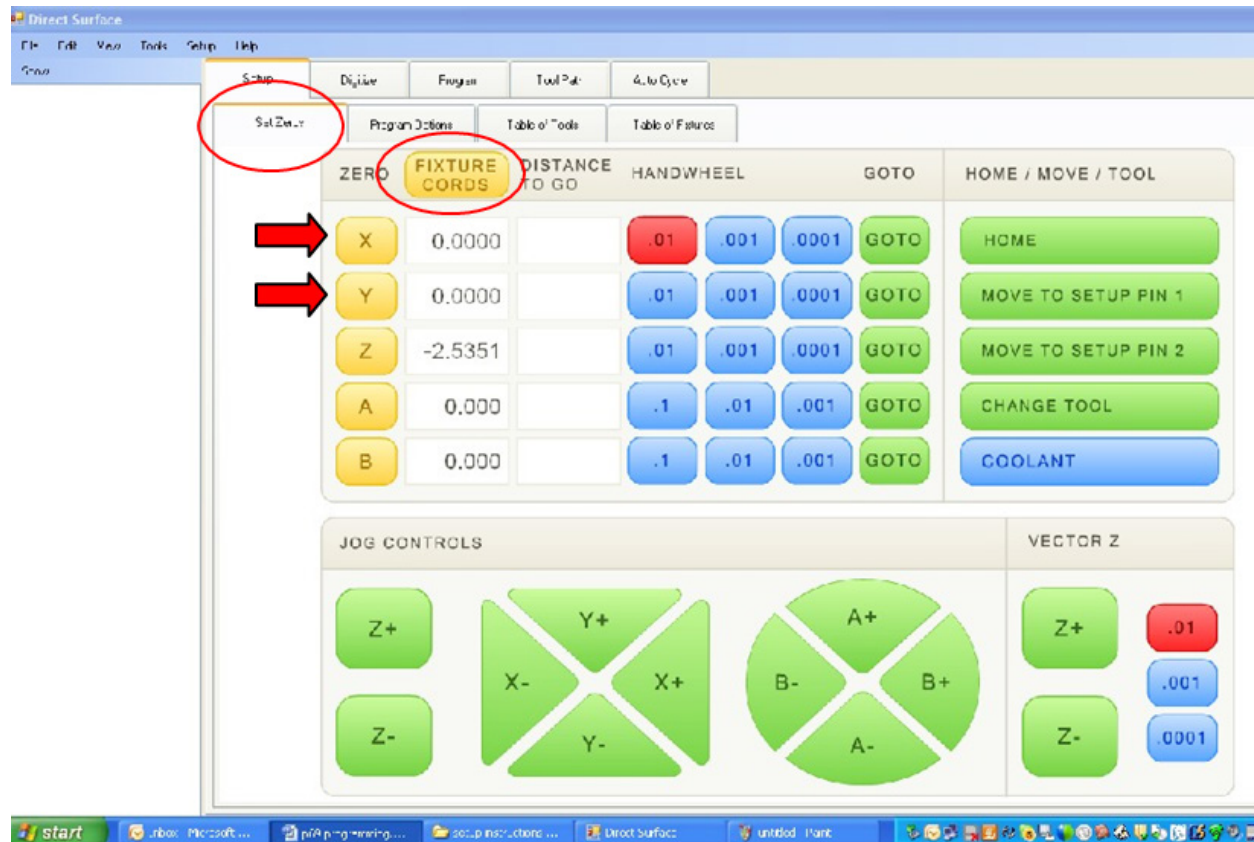

## Defining Tool Length and Probe Length Offsets

All tools and probes will be touched off on the flat side of the 4th axis head stock, opposite to where the plate gets mounted. Note that the flats on the 4th axis have two different dimensions from the center of rotation. One flat is 2" from center the other flat is 2.5" from center. The 2" dimension will be positioned at A0.000. The 2.5" dimension will be positioned at A180.00. All tools and probes will be established from the 2.5" side.

### Probe Length

To define probe height, position probe just over the flat of the 4th axis. Turn the probe on by clicking on the 'Table of Tools' tab (shown below) and click on the "Start Probe" button, or by going into "Program Options" and clicking on "Program Auto Center" button and then press "start Probe" located in the bottom left corner. The probe should start blinking green. Move probe down on top of the flat surface next to the pin, until the probe changes from green to red. Start in .010 increments and work your way down to .0001 hand wheel increments so that you know that you are positioned within .0001" from the flat of the 4th axis.

Next, click on your 'TABLE OF TOOLS' tab as shown below. In this case highlight and double click tool number 3 which is defined as the long probe. When you double click a box will appear. Click on get tool length. A second box will appear labeled 'Tool length Measure'

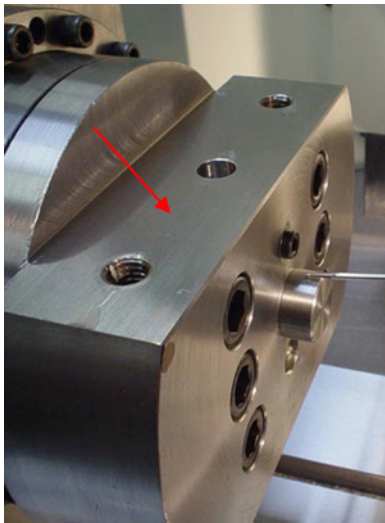

***Touch all cutters and probe off on the head of 4th axis at position 180 degrees as shown by the red arrow above. The dimension from the center of rotation to the flat positioned at 180 degrees is 2.5000"***



Table of Tools

Tool Number	Tool Name	Tool Diam.	Tool Length	Type of Tool	Description
0	HPROBE SH	0.0000	0.0000	FlatEndmill	xxxxxxxxxxxxxxxxxxxxxxxxxxxx...
1	short probe	0.2360	1.0560	FlatEndmill	
2	Medium Probe	0.2360	3.4117	FlatEndmill	
3	long prob	0.2360	3.6344	FlatEndmill	
4	.077 probe	0.0770	2.2390	FlatEndmill	
5		0.0000	0.0000	FlatEndmill	
6		0.0000	0.0000	FlatEndmill	
7		0.0000	0.0000	FlatEndmill	
8		0.0000	0.0000	FlatEndmill	
9		0.0000	0.0000	FlatEndmill	
10	#1/4 TOOLS	0.0000	0.0000	FlatEndmill	xxxxxxxxxxxxxxxxxxxxxxxxxxxx...
11	short 1/4	0.2500	-1.7137	FlatEndmill	STRAK 1/4X1/4 BALL
12	1/4 tool	0.2500	-0.1341	FlatEndmill	DM250-500-5400
13	1/4 thin tool	0.2500	0.4584	FlatEndmill	test 1/4 thin tool for small 4...
14	Long 1/4 tool	0.2500	0.5313	FlatEndmill	
15		0.0000	0.0000	FlatEndmill	
16		0.0000	0.0000	FlatEndmill	
17		0.0000	0.0000	FlatEndmill	
18		0.0000	0.0000	FlatEndmill	
19		0.0000	0.0000	FlatEndmill	
20	#3/8 TOOLS	0.3750	-2.0000	FlatEndmill	xxxxxxxxxxxxxxxxxxxxxxxxxxxx...
21	3/8 5.5	0.3750	0.5485	FlatEndmill	PT-625-375-55
22	3/8 6.0	0.3750	0.5485	FlatEndmill	PT-625-375-60
23	3/8 6.5	0.3750	1.1281	FlatEndmill	PT-625-375-65
24	3/8 7.0	0.3750	0.6156	FlatEndmill	PT-625-375-70
25	3/8 5.5 + .250	0.3750	0.1456	FlatEndmill	PT-625-375-55 - Same as ...
26	3/8 6.0 + .250	0.3750	0.5281	FlatEndmill	PT-625-375-60 - Same as ...
27	3/8 6.5 + .250	0.3750	0.6156	FlatEndmill	PT-625-375-65 - Same as ...
28	3/8 7.0 + .250	0.3750	0.6156	FlatEndmill	PT-625-375-70 - Same as ...
29	3/8 shear	0.3750	-1.8391	FlatEndmill	
30	#1/2 TOOLS	0.0000	0.0000	FlatEndmill	xxxxxxxxxxxxxxxxxxxxxxxxxxxx...
31	1/2 STD T...	0.5000	-0.0485	FlatEndmill	DM-500-500-5400
32		0.0000	0.0000	FlatEndmill	
33		0.0000	0.0000	FlatEndmill	

Distance from Ball Center	Diameter	Color
0	0.236	Color [R...
0.118	0.125	Color [L...
4	0.125	Color [L...
4	1.25	Color [A...
6	1.25	Color [D...
7	0.75	Color [D...

Note there is a value of 2.500" in the 'Z Touch off Height' field. Since we are using a probe and touching directly on the 4th axis flat to establish the height the value will be set at 2.500" to adjust the height offset number from the flat to the center of rotations(all probe and tool Z zero's are established at the center of the 4th axis rotation).

Cutting tools are set up slightly different than probes due to the fact that we can't hand wheel the cutter down to the 4th axis flat without fracturing the tool. The tool length measurement shown below shows 2.600" in the 'Z touch off Height' field. This is because a .1000" gauge block will be used to touch off this cutter. In this case a hand wheel was used to move the tool in positive Z until the .1000" gauge block was able to slide through while in .0001 mode. Just like the probe, start out in .010 to get your Z within .010 of the 2.600" value then change increment to .001, then .0001. The figure below shows a cutter being touched off with a .1000" gauge block. (Note: The distance between the top of the .1000" gauge block and the center of the 4th axis rotation point is 2.6000). Also do not forget that A must be set at exactly 180 degrees.

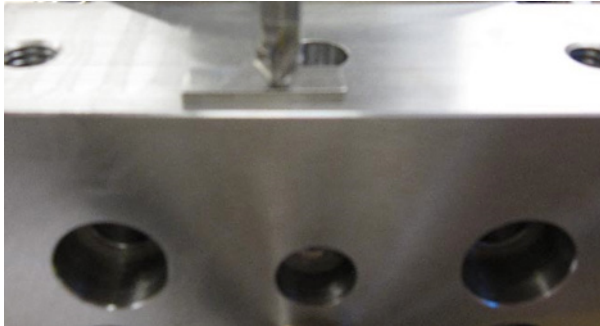

**ToolOptionsForm**

Name: 3/8 6.0 + .250

Diameter: 0.3750

Length: 0.5351

Type: Flat Endmill

Description: PT-625-375-60 - Same as Tool #22 only pulled out .250

**ToolLengthMea...**

Z Location from Zero: 0.0000

Z Touch off Height: 2.6000

Add Tool Radius?

Final Tool Length: -2.7875

**Tool Shank Profile**

Distance from Ball Center	Diameter	Color
0	0.375	Color [...]
0.1875	0.298	Color [...]
0.76	0.298	Color [...]
4.035	0.625	Color [D...]
4.2825	0.625	Color [...]
4.2835	0.763	Color [...]
4.5075	1.25	Color [...]
4.9075	1.25	Color [...]
4.9085	1.8	Color [...]
5.0575	1.8	Color ID...

## DIGITIZING

### Starting a New Head

Make sure Setup tab is depressed

Right click in the white space on the left side of the control located under the 'Show' button. Then left click on add new head. Right click on 'New Head' and rename it to the head that you are working on (I.E. LS1 head).

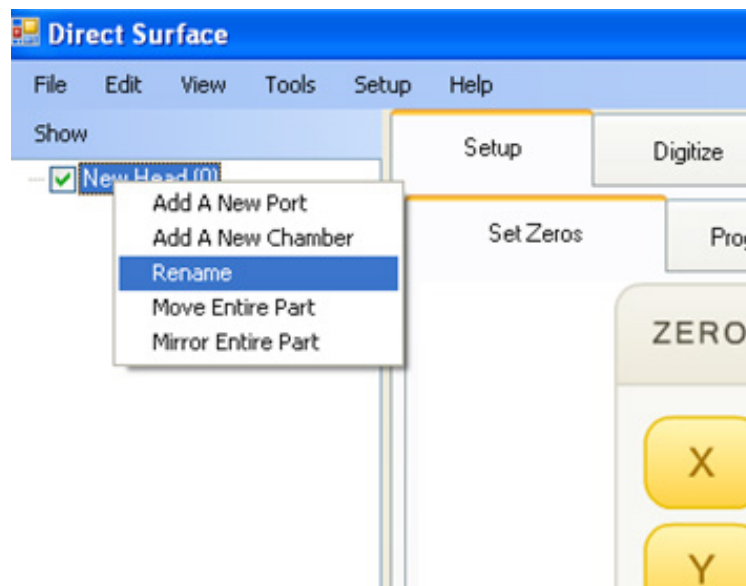
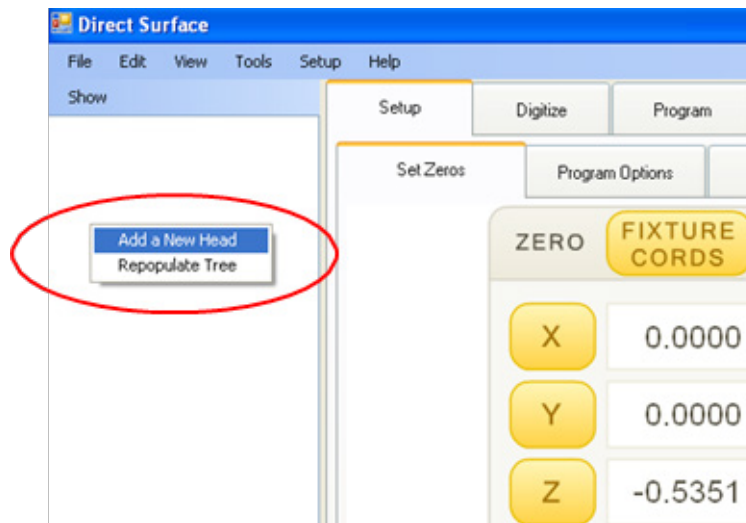

## Creating a Port

To add a port right-click on your newly named head and then click on 'Add A New Port'.

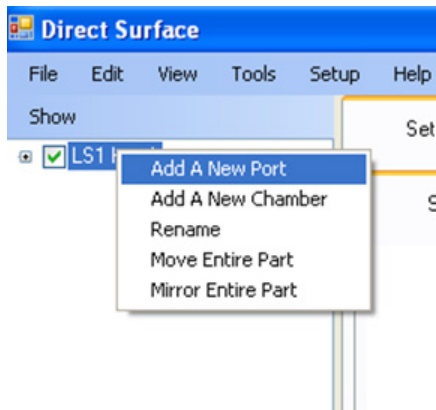

Click on the (+) sign to expand the tree.

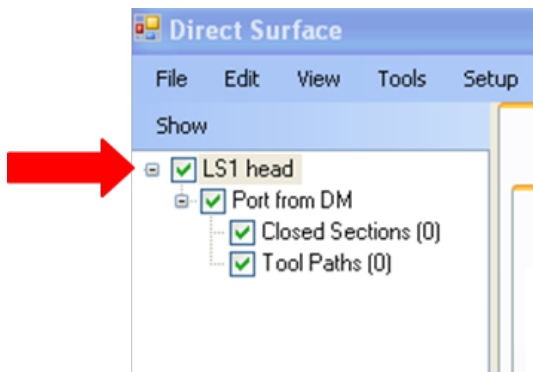

Right click on 'Port from DM' and rename. In this example I have renamed the port to 'EXHAUST PORT'

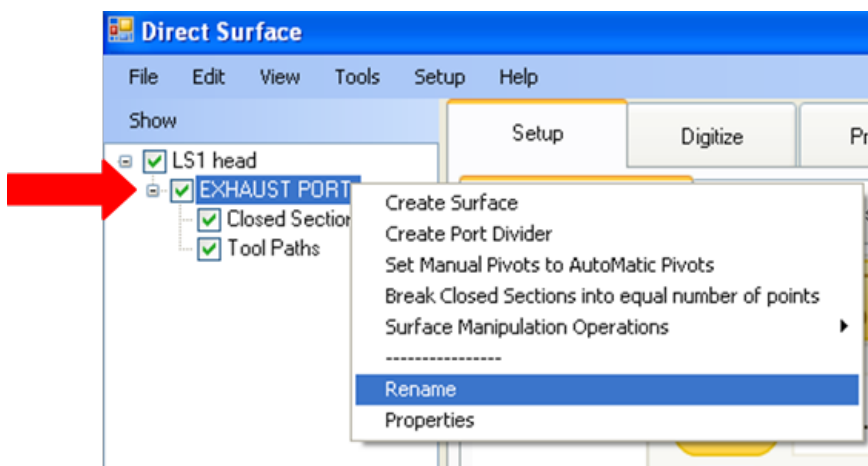

## Digitizing a Port

- There are three planes that need to be defined by using the hand-wheel in order to create a road map for the automated digitizing process. It takes three points to define a plane. We will be using X,Y,Z, A, and B axes in order to define each of the three planes. We will start off by focusing on the exhaust port. The intake port(s) will be done in the exact same fashion.
- With regards to the exhaust port the three planes that we need to define occur at the exhaust manifold side, the middle of the port (where the major transition takes place), and lastly the valve seat area.
- The planes that we define are simply approximate positions. There is nothing precise here. We are simply defining where we need the probe to move so that it can begin its automatic digitizing process. See the diagram below.
- Plane #1 will be digitized from the Manifold side.
- Plane #2 can be digitized from either seat or exhaust side, whichever is easiest. With some experience working with different head you will easily determine from which side is best.
- Plane #3 will be found from seat side and you will position the A axis such that the seat will be facing upward as you did with the manifold side.

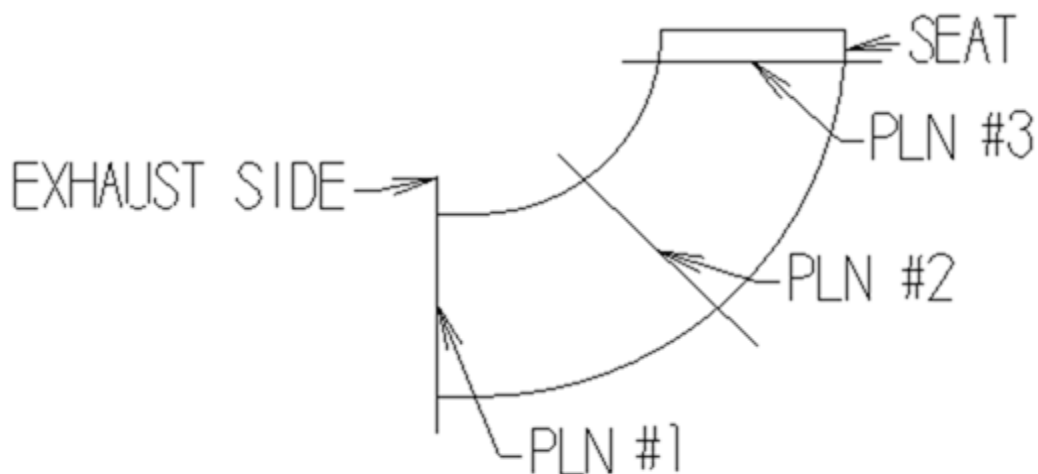

## Creating Planes

Make sure that your probe is set to active in the 'Table of Tools' tab.

### TABLE OF TOOLS

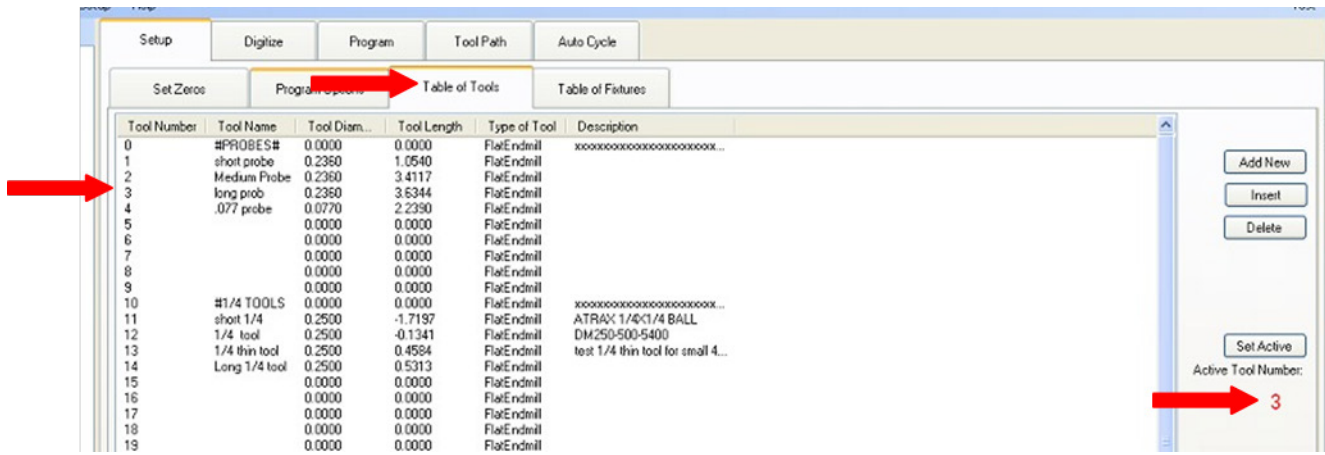

Tool Number	Tool Name	Tool Diam...	Tool Length	Type of Tool	Description
0	#PROBES#	0.0000	0.0000	FlatEndmill	xxxxxxxxxxxxxxxxxxxxxxxxxxxx...
1	short probe	0.2360	1.0540	FlatEndmill	
2	Medium Probe	0.2360	3.4117	FlatEndmill	
3	long prob	0.2360	3.6344	FlatEndmill	
4	.077 probe	0.0770	2.2350	FlatEndmill	
5		0.0000	0.0000	FlatEndmill	
6		0.0000	0.0000	FlatEndmill	
7		0.0000	0.0000	FlatEndmill	
8		0.0000	0.0000	FlatEndmill	
9		0.0000	0.0000	FlatEndmill	
10	#1/4 TOOLS	0.0000	0.0000	FlatEndmill	xxxxxxxxxxxxxxxxxxxxxxxxxxxx...
11	short 1/4	0.2500	-1.7197	FlatEndmill	ATRAx 1/4x1/4 BALL
12	1/4 tool	0.2500	-0.1341	FlatEndmill	DM250-500-5400
13	1/4 thin tool	0.2500	0.4584	FlatEndmill	test 1/4 thin tool for small 4...
14	Long 1/4 tool	0.2500	0.5313	FlatEndmill	
15		0.0000	0.0000	FlatEndmill	
16		0.0000	0.0000	FlatEndmill	
17		0.0000	0.0000	FlatEndmill	
18		0.0000	0.0000	FlatEndmill	
19		0.0000	0.0000	FlatEndmill	

Go back to the main control by clicking on the 'Set Zeros' tab. Then, right click on Closed Sections.

## PLANE #1

First rotate the A-axis to get the manifold side flat, to define plane #1 you will use 3 points that are spaced at approximately 120 degrees apart. You will pick these points up using the hand-wheel. The hand wheel can be move in X, Y, or Z to find the three points. To collect the three points you will use the tip of the probe. See the photo below to view how the points are established on this plane. Then we will need to move the plane half the diameter of the probe once the plane has been defined. Again, it doesn't need to be perfect, just close.

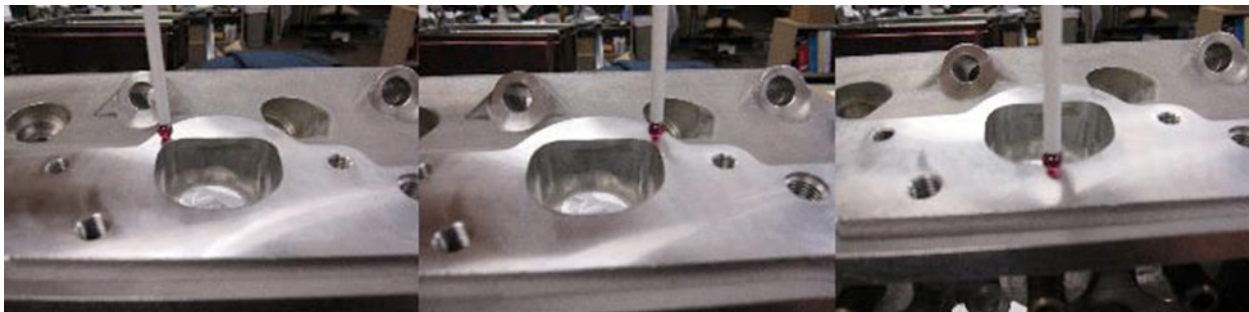

POINT #1

POINT #2

POINT #3

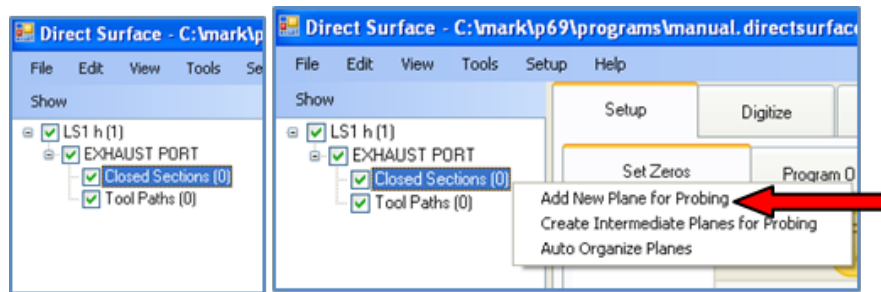

Right click on “Closed Sections” then click on “Add New Plane for Probing”. A message will come up verifying that you are using tool #3 as your probing tool. Click ok. An ‘AddPlane Wizard’ will appear. Above you will see locations for Points 1, 2, and 3. Once the AddPlane Wizard comes up it will automatically turn the probe on and it should be blinking green. Note that the probe will automatically turn off after 90 seconds if it goes un- activated. It will reset to zero seconds once activated (note: probe becomes activated when contact is made with the head). Position your probe near where point #1 is from the above photos by using the hand-wheel. Once the probe is in this approximate position, handwheel shown with the “Z” axis in the 0.001 increments, with your probe still active, until the probe has touched the metal surface. Once contact has been made you will see the light of the probe turn red. Hand-wheel the probe back away from the metal surface until the light turns green again.

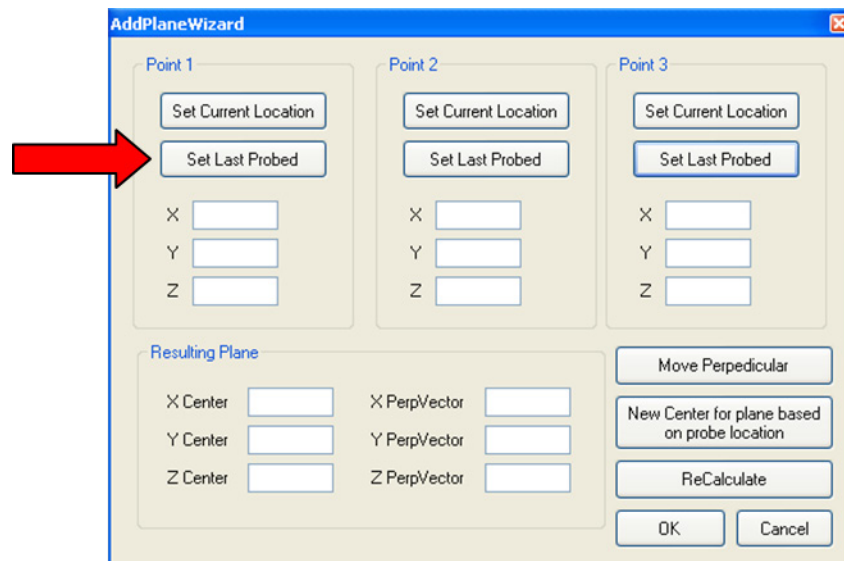

With the AddPlane Wizard still open, under point 1 below, click on ‘Set Last Probed’. This will collect the X,Y, Z point in space at the exact location the probe last made contact with the head. When you are done collecting points #1, #2, and #3 your AddPlane Wizard will look similar the second figure below where all the x,y, and z points have been collected. Click OK. You have now defined plane #1.

(Take note that you will be in the ‘SET ZERO’ location under ‘SETUP’. Also note that the ‘ADDPLANEWIZARD’ will appear over the top of your hand-wheel function in which case you will left click and hold the blue strip on the top part of the wizard to move it to a desired location.)



Below shows that all three points have been defined to create plane #1.

The screenshot shows the 'AddPlaneWizard' dialog box with the following data:

Point	X	Y	Z
Point 1	10.2624	0.5160	-2.3387
Point 2	10.8823	1.3911	-3.8427
Point 3	9.3724	1.3899	-3.8433

Resulting Plane	
X Center	10.0828
Y Center	0.9980
Z Center	-3.1684
X PerpVector	0.0014
Y PerpVector	-0.8644
Z PerpVector	-0.5029

Buttons: Set Current Location, Set Last Probed, Move Perpendicular, New Center for plane based on probe location, ReCalculate, OK, Cancel.

Once these points have been picked up using the 'Add New Plane for Probing' function followed by the plane wizard we must move the plane by half the diameter of the probe which is 0.118.

If we did not move the plane down into the work it would start its automatic digitizing routine .118 above the manifold surface. By moving the plane down .118 we are forcing the probe to start probing at that level shown in Fig.3, otherwise the probe would start probing at the level shown in Fig 4 and produce an undesirable outcome. Essentially, the probe would move out looking for a wall and wouldn't be able to find one.

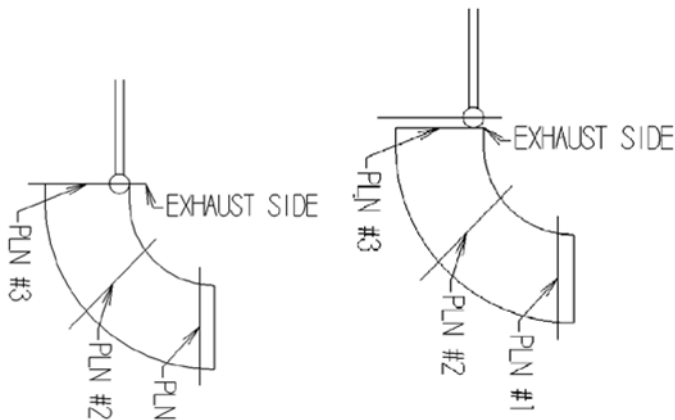
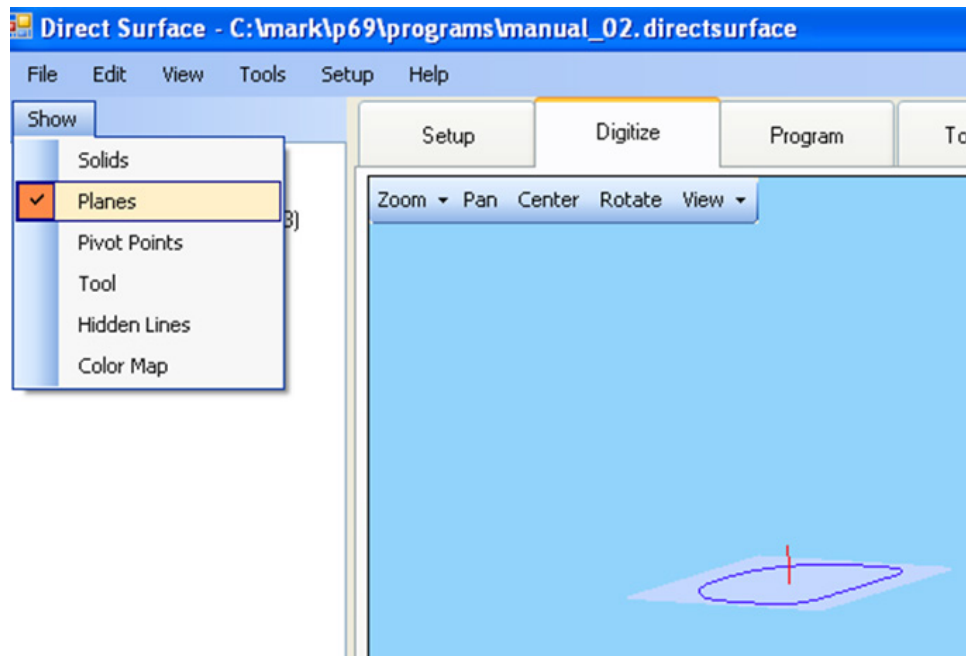

FIG.3

FIG. 4



To manipulate the plane down into the port by.118 first ensure that you have planes checked as shown below. Also, you will want to have the 'Digitize' tab selected.



Next, double click 'ORIGINAL PLANE' listed under manifold side as shown below. This will reopen the 'ADDPLANE WIZARD'. Next, click on the 'Move Perpendicular' button.

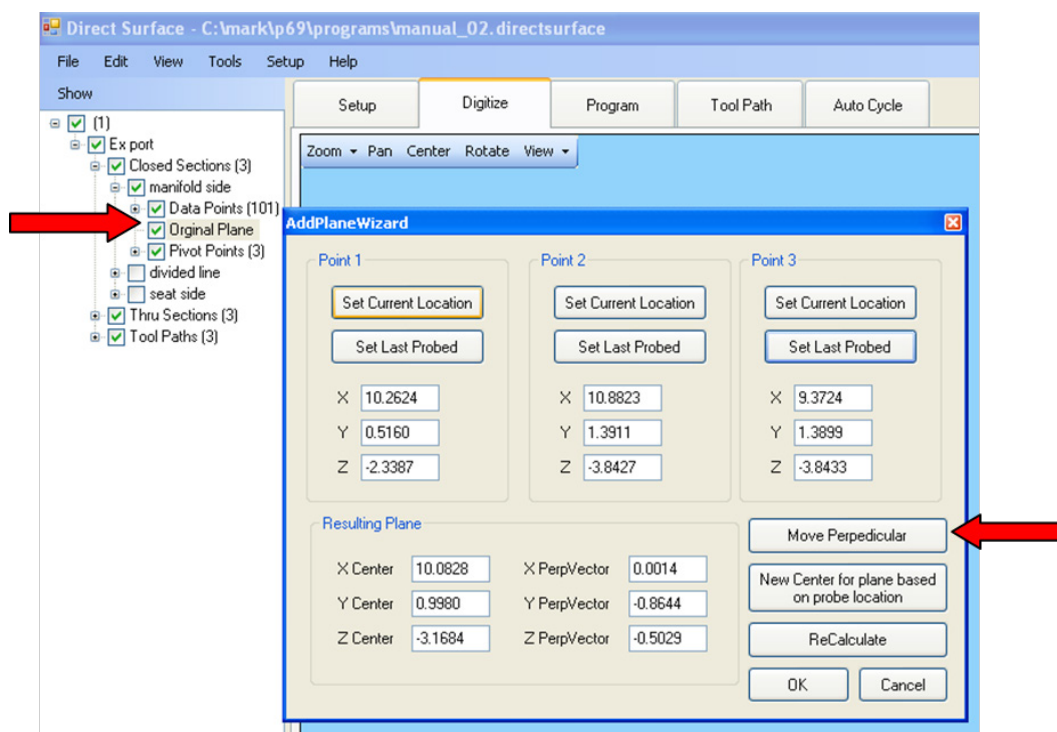

Type in either .118 or -.118 in the field shown below. The red line below shows a positive direction. To move the plane to the opposite side of the red line type in .118. Notice the 'Digitize' tab is selected. Again, .118 represents half of the probe diameter. The full diameter of the probe is .236(6 mm).

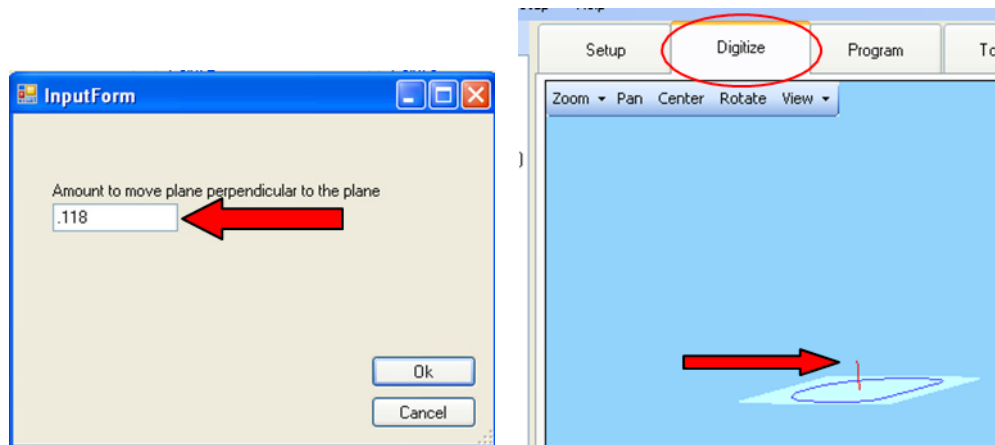

## PLANE #2

Plane #2 can be the most difficult to define. You will be using the side of the probe to pick up the three different points that will be making up the plane, instead of using the tip of the probe as used on the previous plane. So there will be no need to move the plane after it has been set. Start by going back to the step to create a plane and clicking on "Add a New Plane for Probing" to activate the "AddAPlaneWizzard".

Hand wheel X, Y, Z, A, and B around until you can position the probe to the approximate points shown below. Points #1 and #2 can be picked up just to the left and to the right of the valve guide, being straight across from each other, as square as possible to the valve guide. (Make sure that only the ruby is touching the port and not the shank of the probe).



POINT #1

POINT #2

POINT #3

POINT #3 SIDE VIEW

Point #3 is the short turn radius point and can be the most difficult point of the 3 to define. It will need to be directly across from the 1st and 2nd point. This point has to be reached from both sides, meaning the seat side and the exhaust side, such that the shank does not hit in either case. (See drawing below).

The A-axis is rotated at an angle such that the probe and or cutter could contact point #3 from either the seat side or the exhaust side. Notice point #3 side view how angled the A-axis is to allow the probe to get to that transition point from either side.

Figures 1 and 2 show an example of the probe able to reach from each side at a particular angle. To re-emphasize, plane 2 can be defined from either the seat or exhaust side, whichever is the easiest to reach. The pictures below shows this plane being picked up from the seat side. If the A-axis is not rotated enough you will not be able to get at this point from the other side. Likewise, if you rotate the A axis to far over you will hit the shank before the ruby touches. There has to be a "line of sight" coming in from both directions. Sometimes it can take a couple of minutes to get your probe positioned where you like in which case the probe may shut off automatically. If this happens simply go into the table of tools and click on the 'Start Probe' button, then click on the 'Set Zeros' tab to get back to the control.

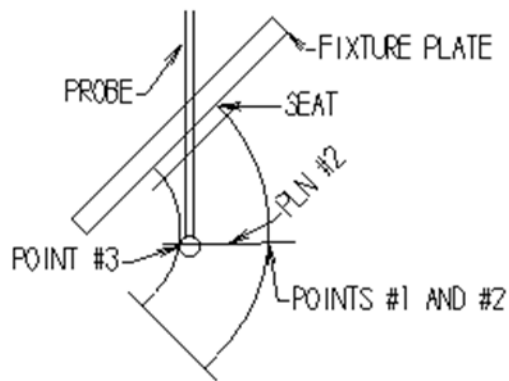

FIG.1

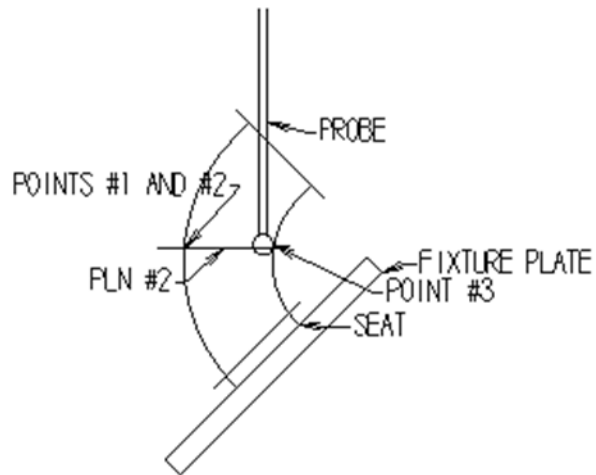

FIG.2- Head flipped 180° from FIG.1

**PLANE #3**

Manually rotate the A-axis such that the plane where the seat meets the head (see red arrow below in point #2). You can rotate the A axis to the angle of the head for example the degree of the head and the seat will be parallel to the table.

Start by clicking on “Add New Plane for Probing” button, then use the “Add A Plane Wizard” to set plane #3. The three points to probe the plane will be as shown on the picture below, right after the valve seat insert finishes (Where the red arrow is pointing at in the picture below)

We will be using the side of the probe, and there will be no need to move the plane perpendicular when it's been set. Try to line up the center of the probe right between the end of the seat insert and the port. Set all three points as shown on the picture then click “OK” on the window to add the plane.

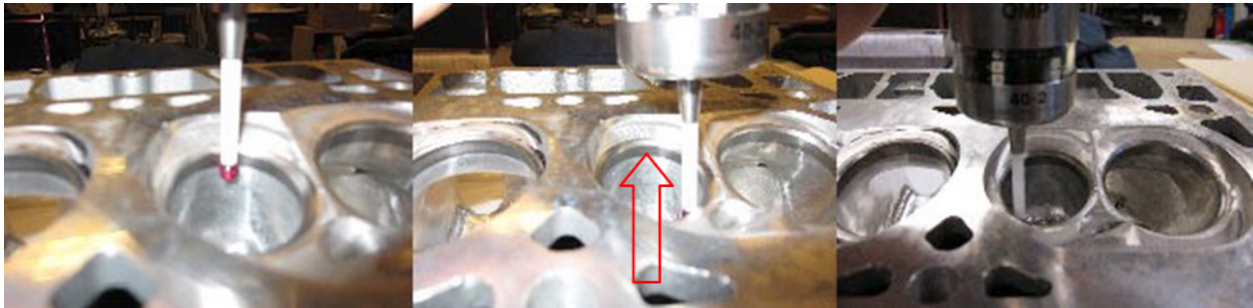

POINT #1

POINT #2

POINT #3

## Creating Intersecting Planes

Now that we have all three planes defined for the port, it is now time to begin our automatic digitizing process. With the 'Digitize' tab still open make sure that all three of the planes have a check mark in each of the boxes. You should now be able to see the three planes that were created. (if you can't view the planes, go to the "Show" button which is marked by the green arrow on the picture below, and make sure that planes is checked) However, at this point you should not see the cross-section shown as blue and red below. You should only be viewing square opaque planes.

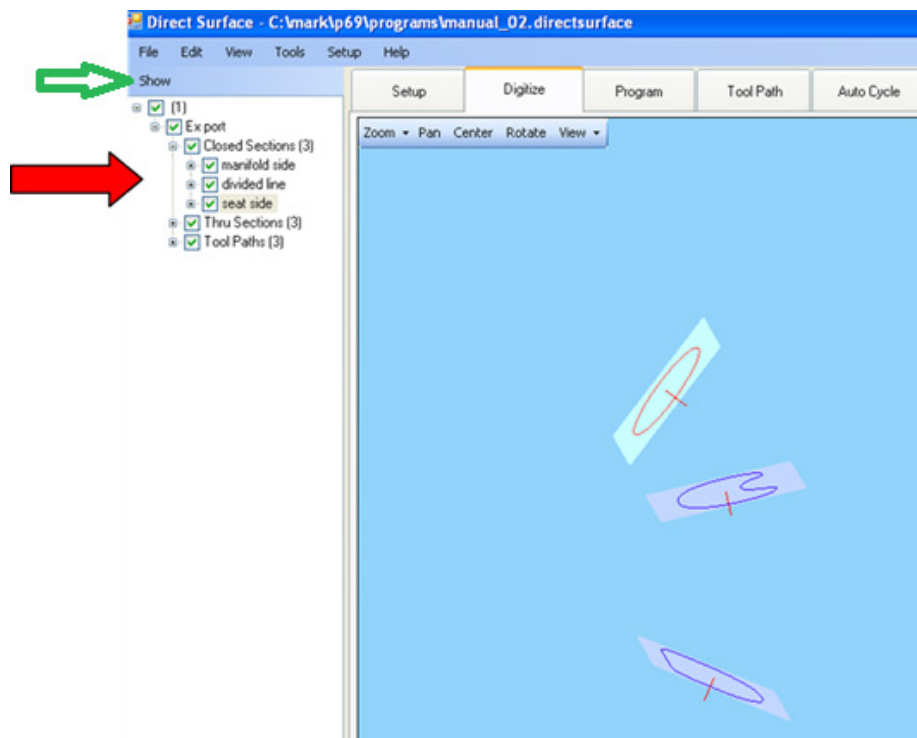

Next, we need to create some intermediate planes that will be located in between plane #1 and plane #2 as well as between plane #2 and plane #3. To accomplish this we need to isolate 2 of the 3 planes by unchecking one of the planes created. As shown below the seat side plane has been unchecked. Looking at the graphics you will now only see 2 planes which in this case include the manifold side plane and the dividing line plane

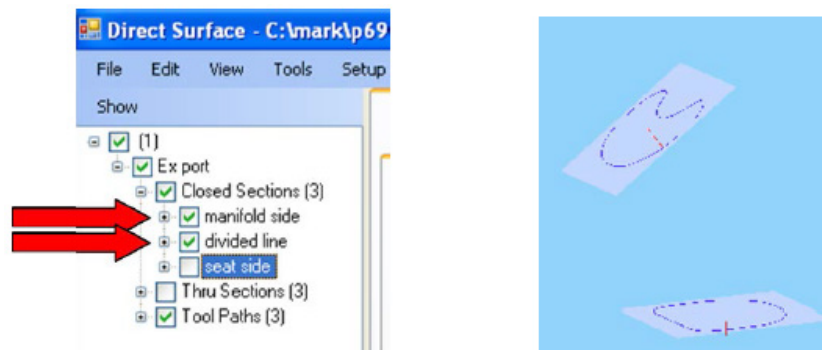

Next, right click on Closed Sections and left click on “Create Intermediate Planes for Probing” like shown below.

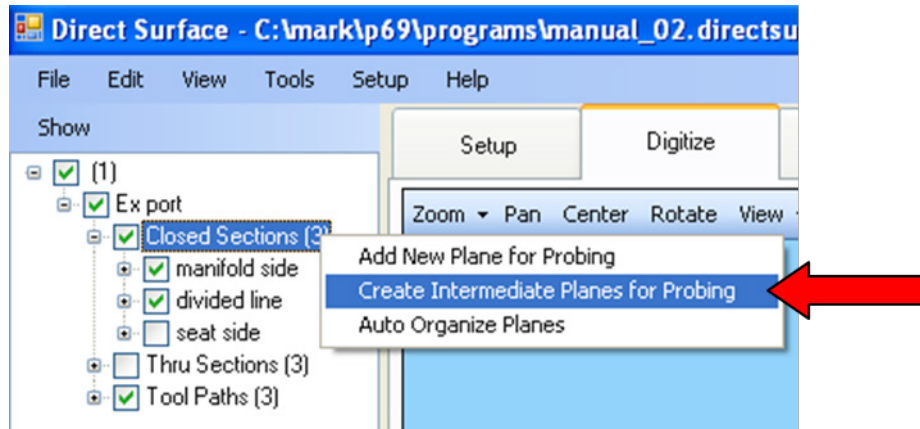

The system will then ask you to input the amount of planes you wish to divide the manifold side and divided line into. This value will determine how many time the probe will step down to begin the digitizing process. In this example we are dealing with an exhaust port for a big block Chevy. Five additional planes should be sufficient for the first half of the port and five additional planes for the other half of the port. The more planes you have the more accurate the port will be. However, too many planes may make no more difference in the overall outcome than if there was a lesser amount. In other words, too many planes may be “overkill” and hence time consuming and unnecessary. A good rule of thumb would be to start out with approximately .500” of spacing in between planes throughout the port

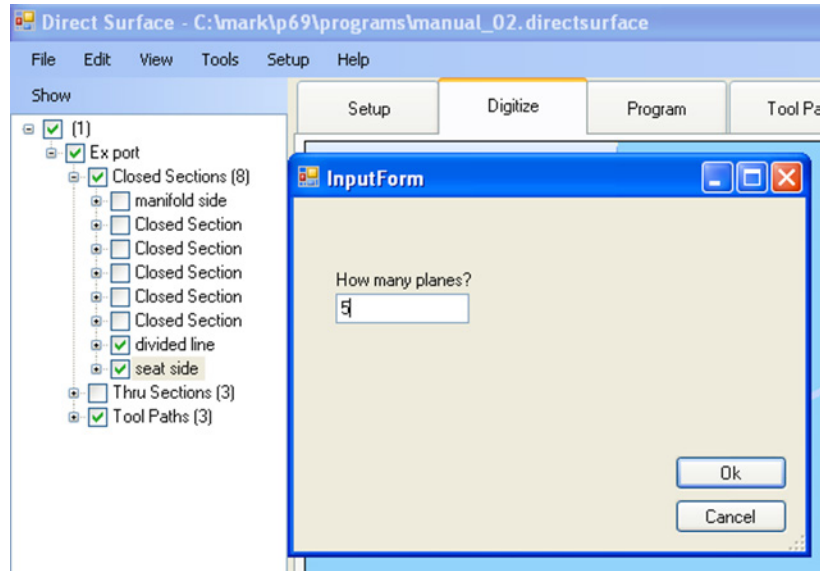

The figure below shows the manifold and divided plane being divided up by an additional 5 planes. Also note that there are 5 new closed sections listed. Each one of the closed sections represents a plane. Try unchecking and checking several of the closed sections and watch in the graphics page the planes turn off then back on again when the closed section is selected.

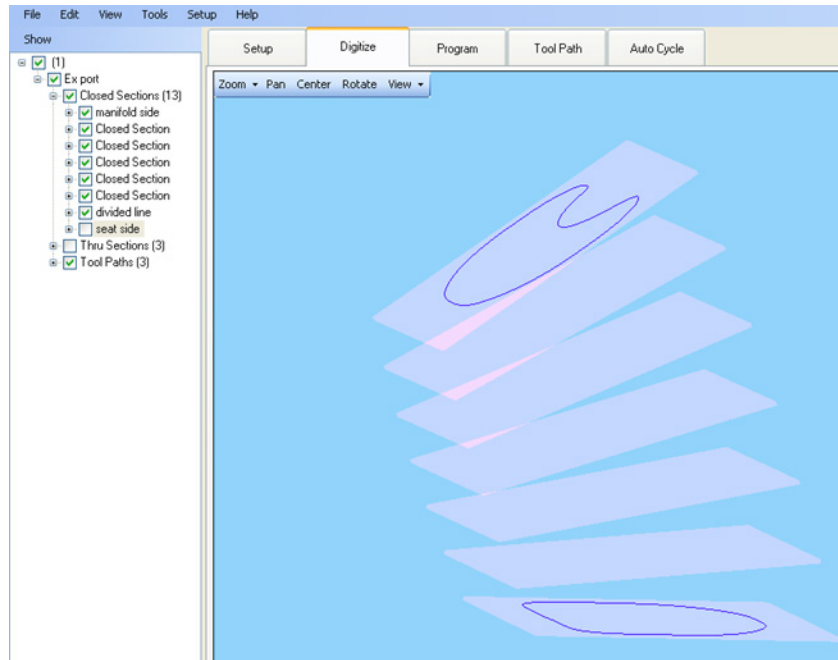

Now we need to create planes for the divided line and the seat side planes. Go back to line #6 and repeat the process only now we will isolate the divided plane and the seat side plane as shown below

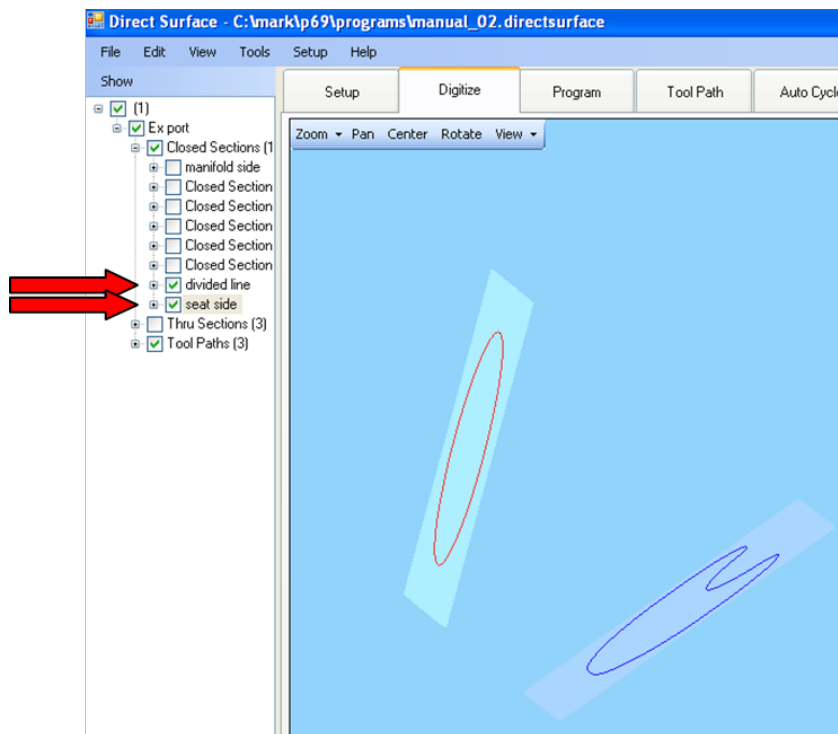



After creating intermediate planes between divided line and seat side you will see that there are five new 'Closed Sections' in between the divided line plane and the seat side plane. When you check everything under Closed Sections you will in the graphics screen all of the probing planes that have been defined and will be used in the automatic digitizing process. Make sure that the plane button is checked when you click on 'show'.

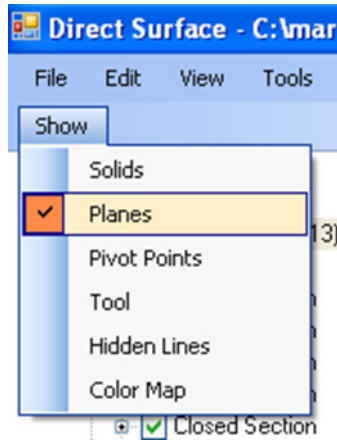

When we begin to digitize the probe will find the center of each of the planes. The probe will then work its way to the wall of the port until it detects contact. Once contact has been made the probe will start finding points at that particular plane level moving over approximately .050 until it works its way around 360 degrees back to the starting location. It will then be ready to digitize the next plane

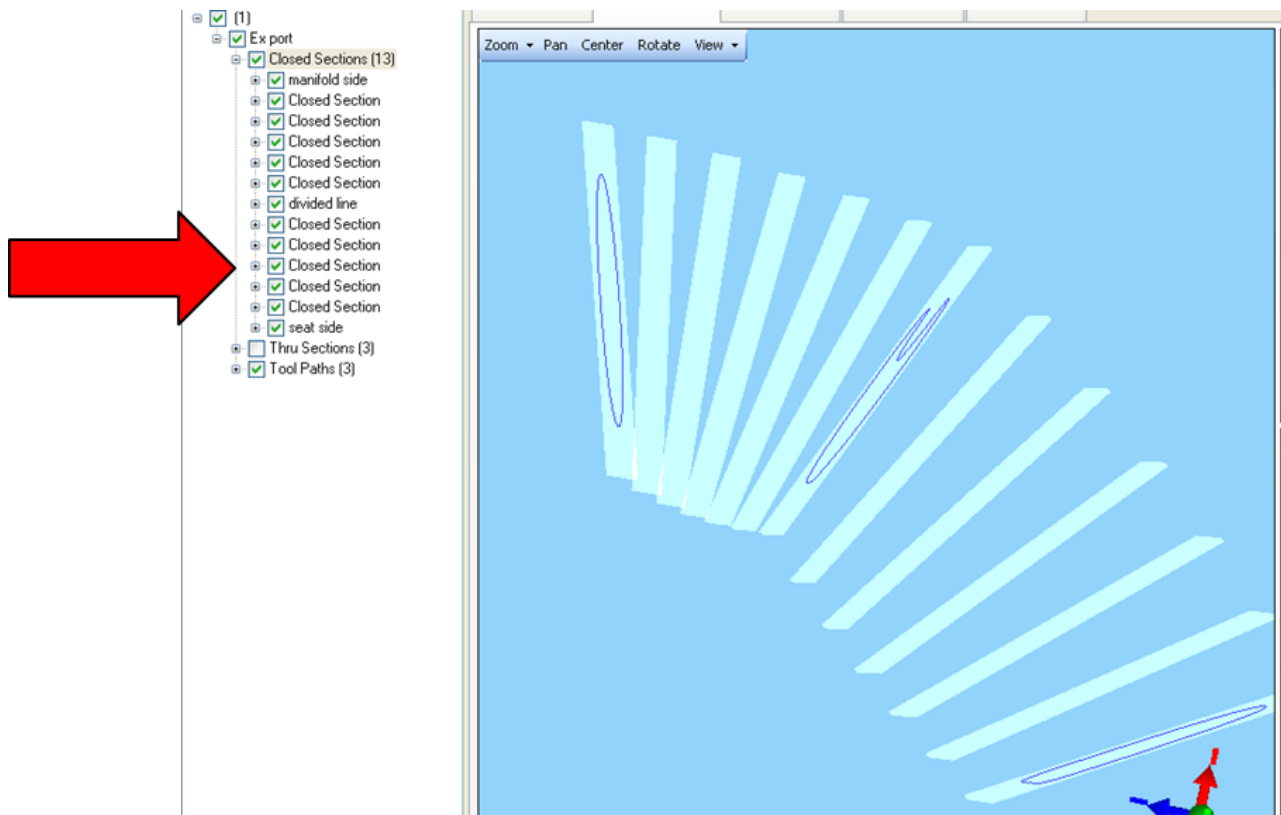



## Probing Defined Planes

When you begin to digitize you will isolate each half of the port by checking the closed sections you wish to probe first. For example you can start off by checking the 'manifold side' through the 'divided side' sections first, as shown below. This will begin the digitizing process starting from the manifold side and in this case to the 'divided line'. Once you probe the dividing line it won't be necessary to probe it again when you start your probing process from the seat side. (when digitizing make sure to have the probe above the plane from where it's going to start)

Notice that the only planes visible on the screen are the "manifold side", "divided line", and "closed section" planes. The planes that represent the other half of the port have been shut off. The planes that we have defined below are simply a road map for the probe to move to begin its digitizing process. The probe will find its way to the middle of each plane then at that level will start moving out to find its way to the edge of the port.

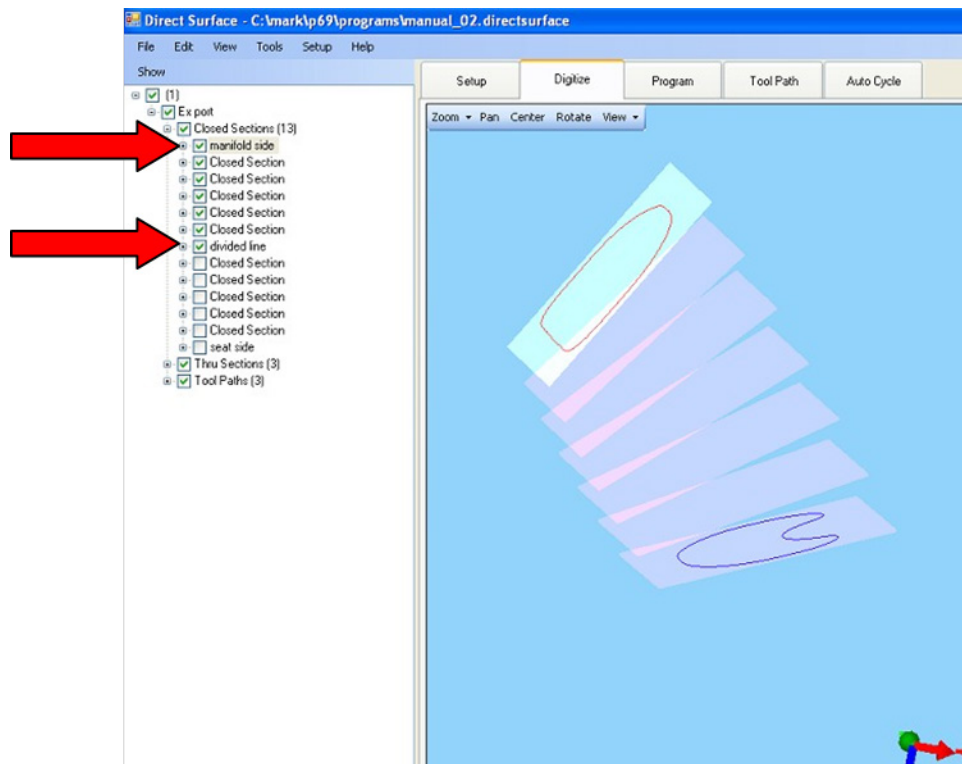

Click on 'Probe Checked Planes' to begin the digitizing process. Initially you may have to click 'Probed Checked Planes' twice as the first time turns probe on. "OK" through comments then the probe should move to the middle of the first plane and begin digitizing.

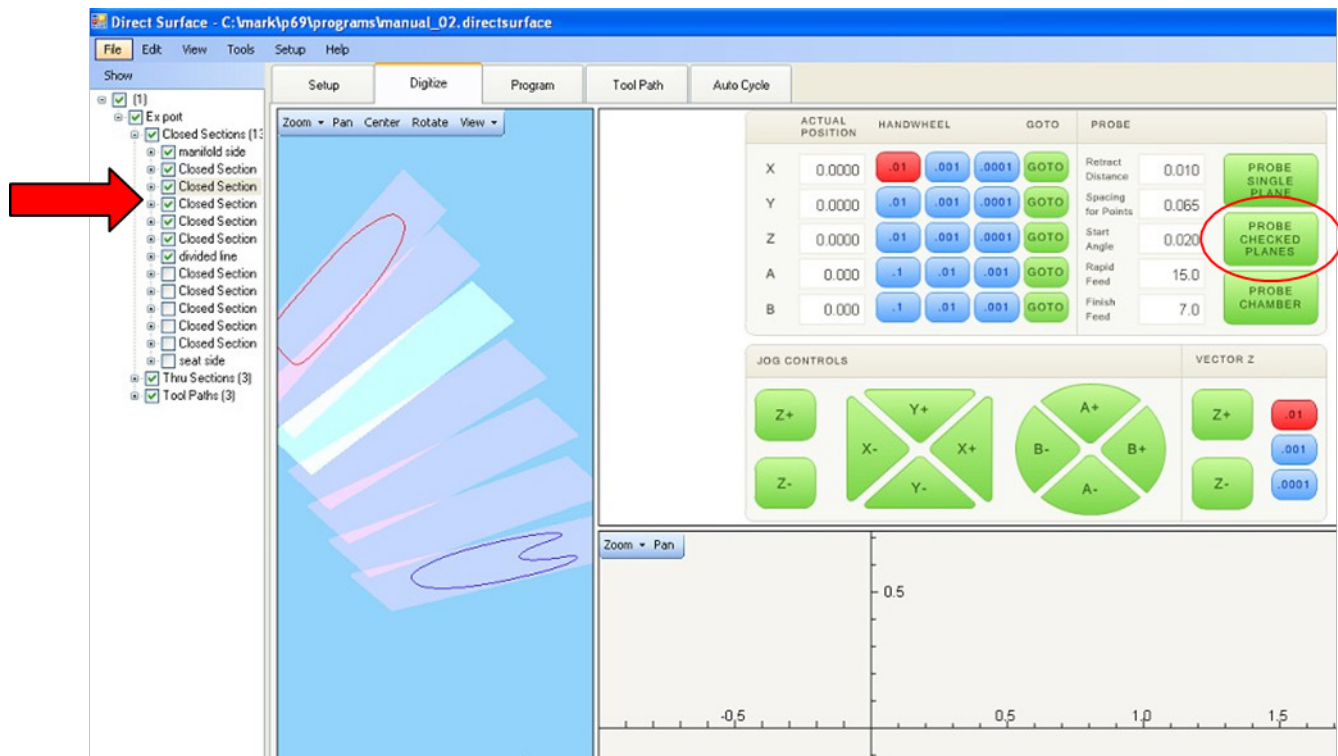

The software will tell you how much the 4th and 5th axis will rotate before it starts to move to the first plane. (it lets you know how much it is moving from the starting position, not moving to that value)

If it tells you that it wants to move to an angle that seems to large it is possible that there is something incorrect about the process and you should proceed with caution. It could simply mean that you have your head positioned on the 4th axis on the opposite side of the port you want to probe.

Once it is finished digitizing a single plane before it moves on to the next plane the software will again inform you of how much the 4th and 5th axis will move to position itself. If the rotation seems reasonable then simply hit 'ok'. (Make sure that the probe is not shanking out while probing, you only want the ball end to be touching the head)

Repeat this process until you have made it through all of the planes that you have checked on the one half of the port. Once it has finished digitizing from the one side you, rotate the block around (either with hand wheel or green rapid buttons) and begin digitizing from the opposite side. In this case the seat side

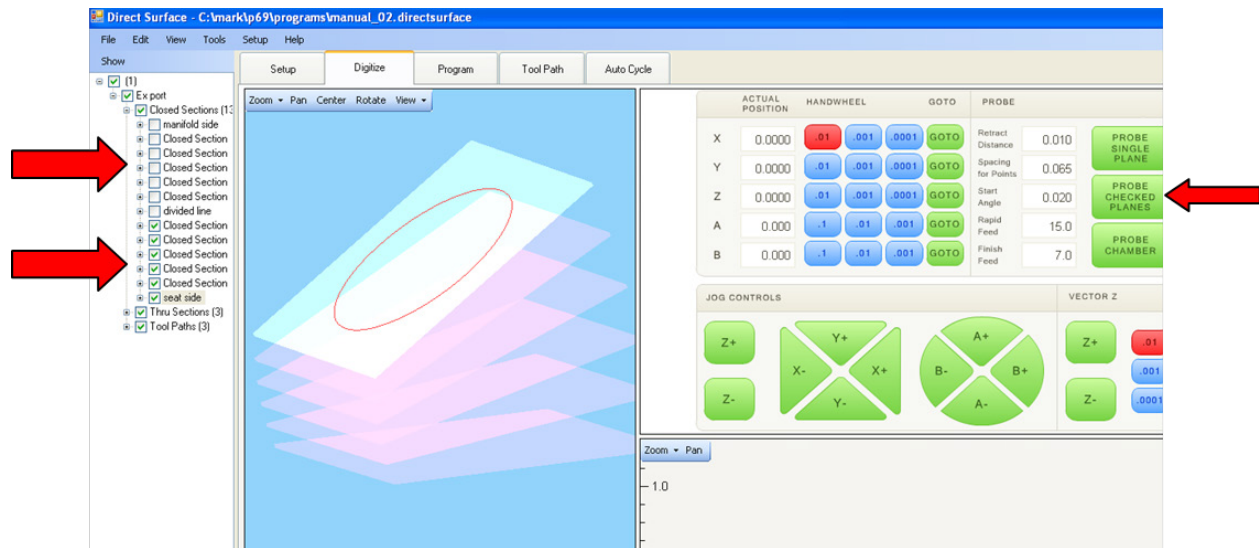

With the probe positioned just above the seat side (in this example) uncheck the closed sections that we just probed and check the remaining closed section planes along with the seat side plane as shown below. Notice this time only the seat side planes are showing. The manifold planes have been unchecked and the seat side planes have been checked. Since we already probed the divided line this will be unchecked.

However, please note that it is possible to probe the divided line along with the seat side of the port. This will be done in the case that the probe was not able to probe from the other side due to shanking while probing. It can vary sometimes depending on where the plane is located in the port and the ease at which the probe can reach this position.

Click on 'Probe Checked Planes' to begin the digitizing process from the seat side. Repeat the same process used from the manifold side until the probe has completed the probing routines throughout all of the planes.

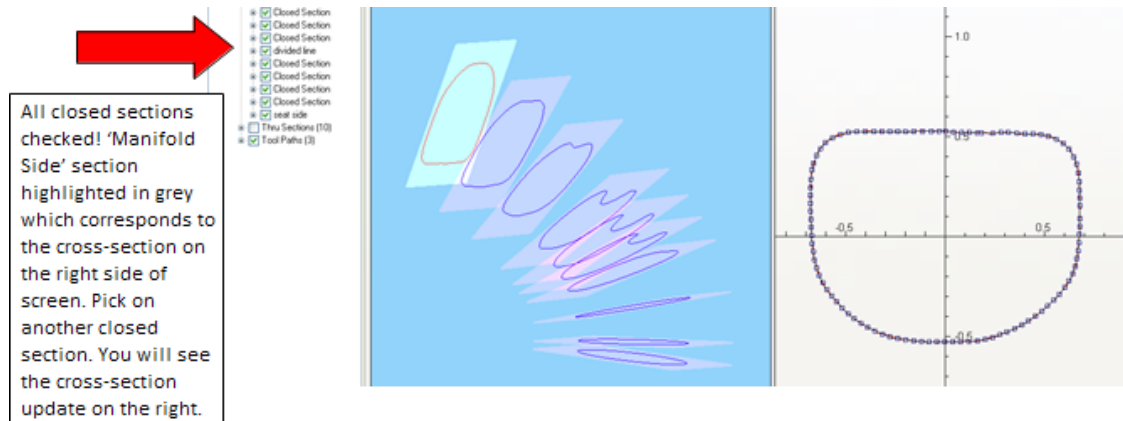

After probing all of the planes you should now see that all of your cross sections at each plane level that have been defined. This time check all of the closed sections including manifold side, divided line, and seat side. Next click on the Program tab and view all of the digitized cross sections that make up the entire port

## Cross-Section Manipulation

The little squares that you see on the right side of the screen are all the points the probe has located when probe made contact with the port. You can use your mouse to move the squares around to obtain the shape you are wanting at each cross-section level.

To accomplish this simply use your mouse and position pointer over the square you want to move and hold your left mouse button down and then move the square into desired location. This is particularly affective if the probe finds its way into a support guide or a bolt hole that has penetrated the port. Look at the before and after below

To make it easier to manipulate the data points and get a better shape, especially on the turns as shown in the picture below. You can select a point and press the "control" key on the keyboard while clicking on the point, then the mouse over the next point and repeat the process, control click. This will highlight the two separate points to use as a reference. Now right click on one of the highlighted points, a window will come up and you can select make arc, then easily manipulate all the data points in between the two highlighted data points.

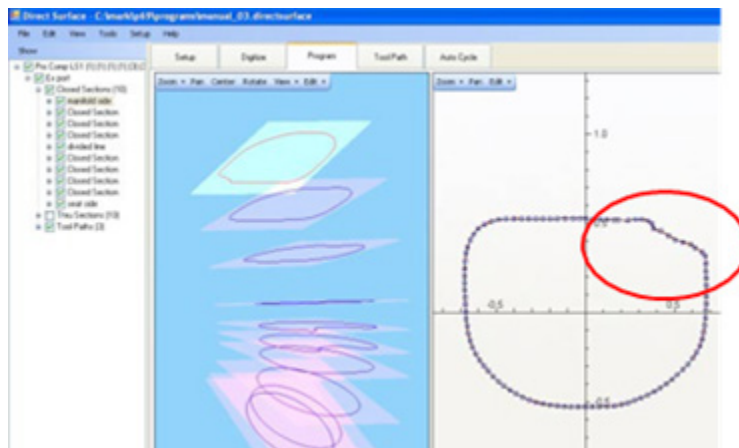

ORIGINAL PROBED DETAIL

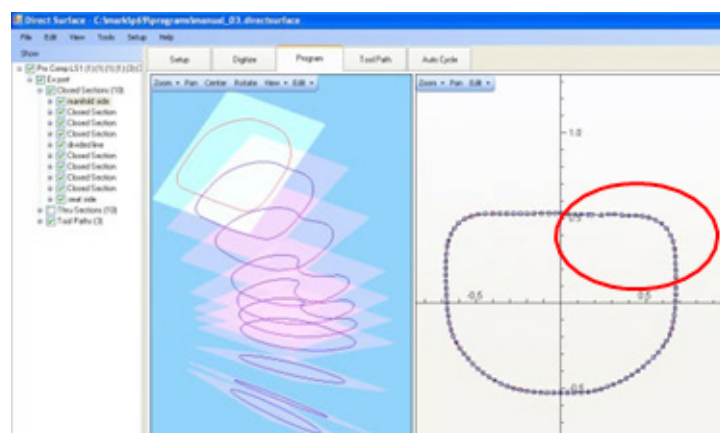

DETAIL AFTER POINTS HAVE BEEN MOVED

## Creating a Surface

Once you have manipulated all of the cross-sections to the shapes that you desire you must now create a surface that will blend all of the cross-sections together. Right click on “Ex port”, or whatever the name was given to the port, then click on “Create Surface”. It will ask you if a guide support exists and if one does click yes. Next it will ask how many thru sections you want to produce. It defaults at a value of 72. Simply hit ‘OK’. It may take a minute or two to generate the surface.

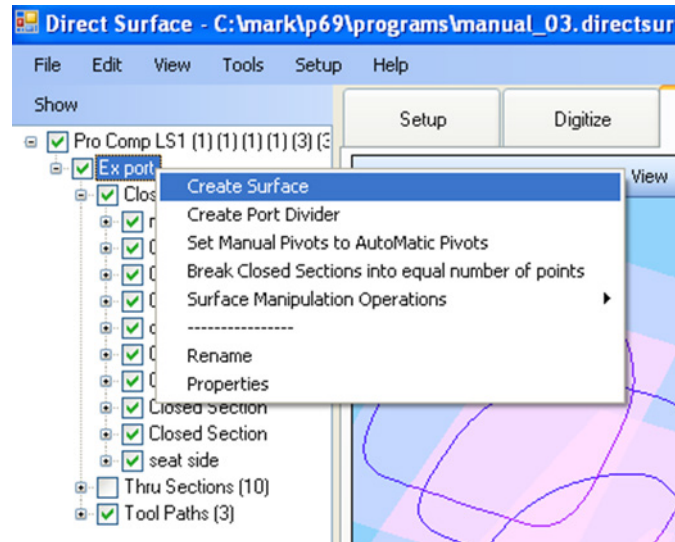

Make sure that “Solid” is checked so that you can view the newly created surface

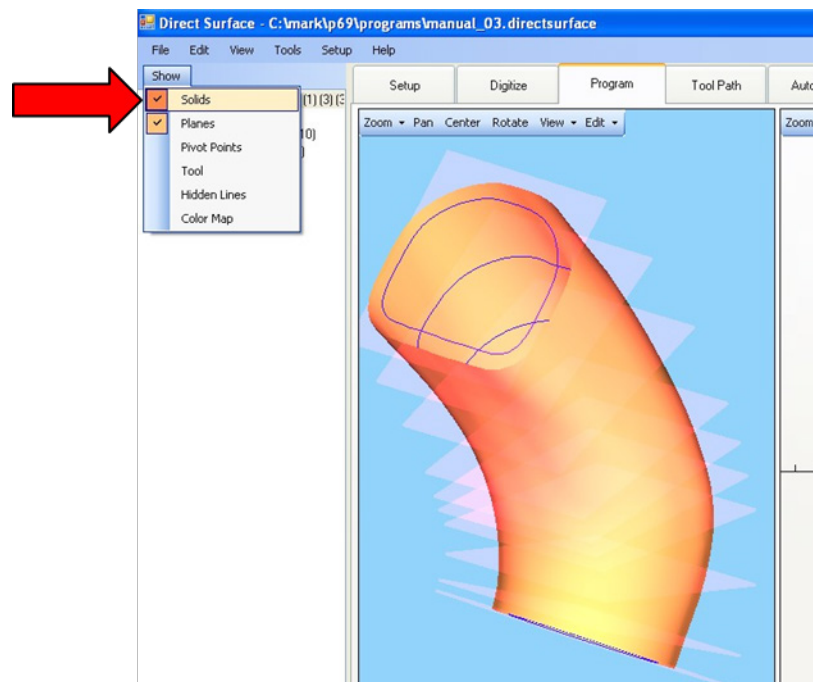



## Surface Manipulation

The next step is to examine all aspects of the surface to ensure that it looks that way you want. Keep in mind that the software calculates the surface base on all of the newly created cross-sections. At this point we can still isolate individual cross-sections and move them to manipulate the surface. See figures below.

These are the exact same cross-sections. Fig A is the originally created cross-section and Fig B shows how the surface can be manipulated by dragging points. This example shows a big bulge in the surface because of the way the points were shaped. Again, if you want to drag points simply left click hold and pull points into position. In this case you can see the surface changing instantly. If you have a tool path already created, which we will cover shortly, changing the surface will automatically update the tool path

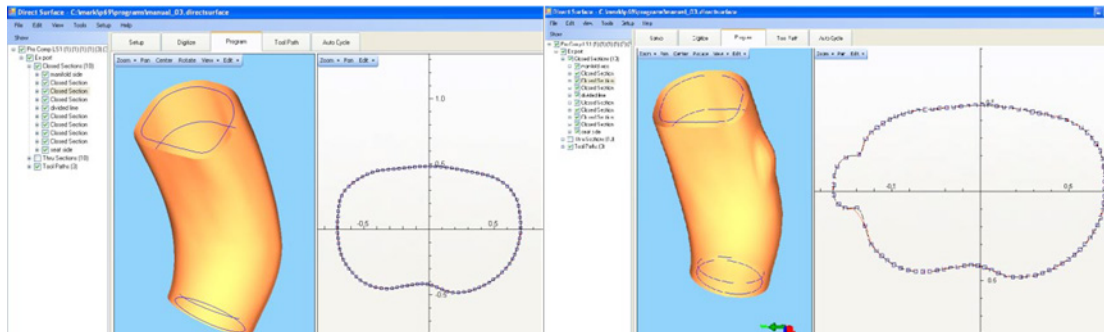
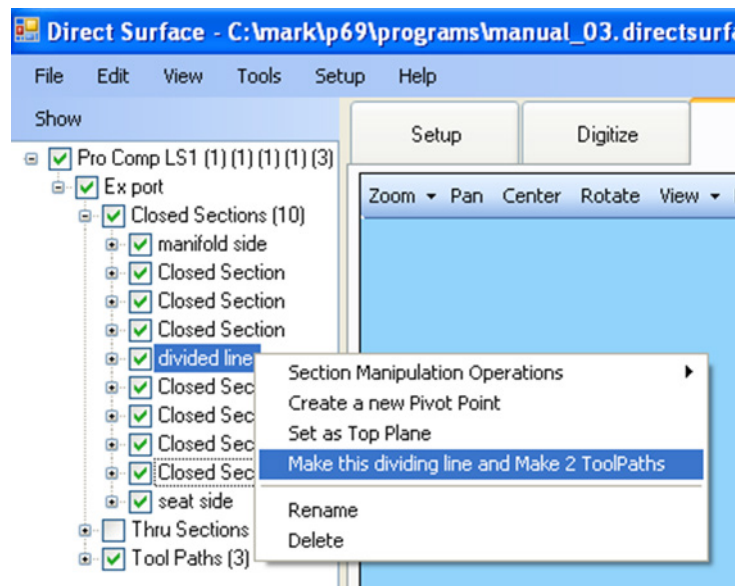

Fig. A

Fig. B

## Creating a Toolpath

Once you are satisfied with the surface that you have just created the next step is to define a tool path. To accomplish this right click on the divided line cross-section in this case then select "Make this dividing line and Make 2 ToolPaths". It will ask you which tool number that you want to use. If for example you want to use tool #26 in 26 then click on OK.



Now, open your Tool Path as shown below and you will see two newly created tool paths labeled “Manifold Side” and “Seat Side”. (you should still be under the program tab).

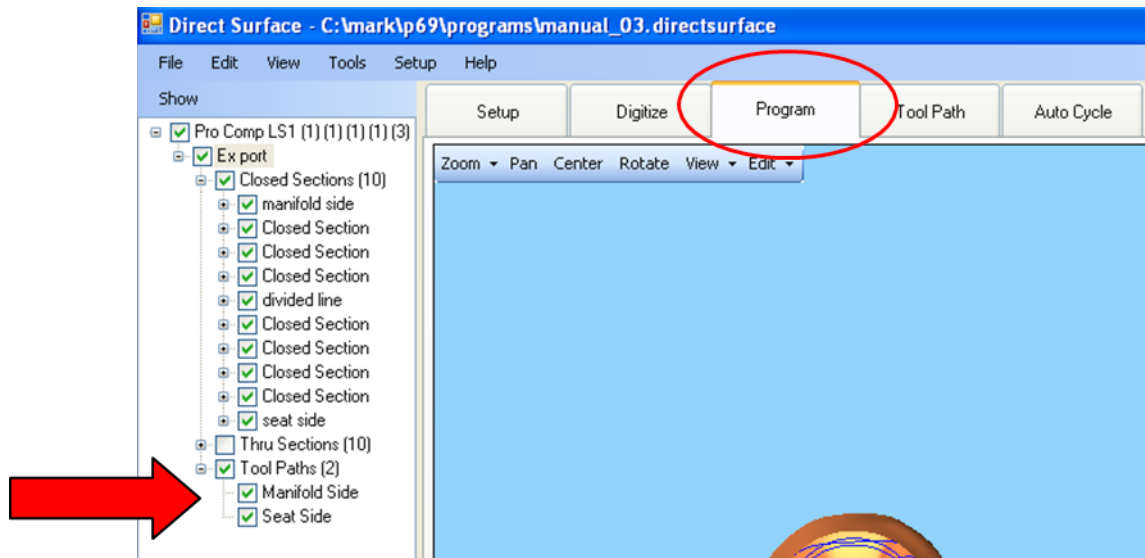

Double click on either of the newly created tool paths and you will see all of the default information that has been loaded. The tool path page is where you can change such things as Step Down Amount, Tool Number, Additional Oversize Amount, Direction of cut, Spindle RPM and Feed rate.

The tool path window should look like the one below

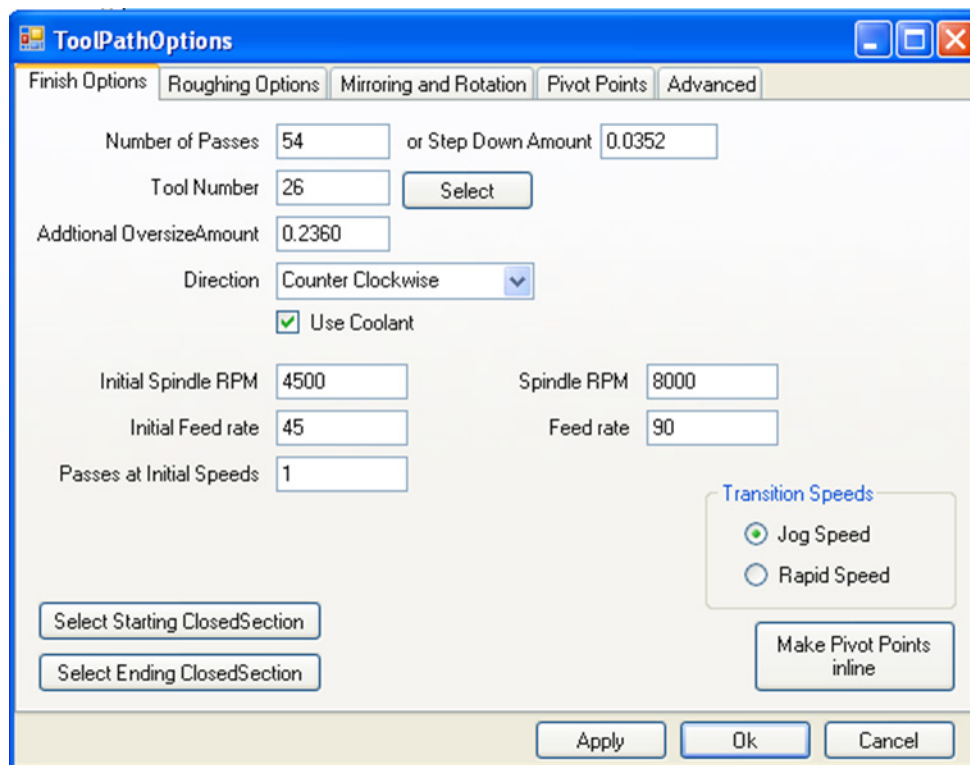

## Creating a Roughing Routine for The Toolpath

To create a roughing routine click on the Roughing Options tab. You will see to the right in the graphics that the cutter steps over 3 times at each level and finishes at each level. In this example the number of passes is 100 the same number as in the finish options. The tool number is the same.

The “Amount to Rough” is the approximate amount of stock that is on the walls of the port to machine. In this example the cutter will take two passes at approximately .150 and a third and final finishing pass of .025. This roughing routine will rough and finish as it works its way down the port.

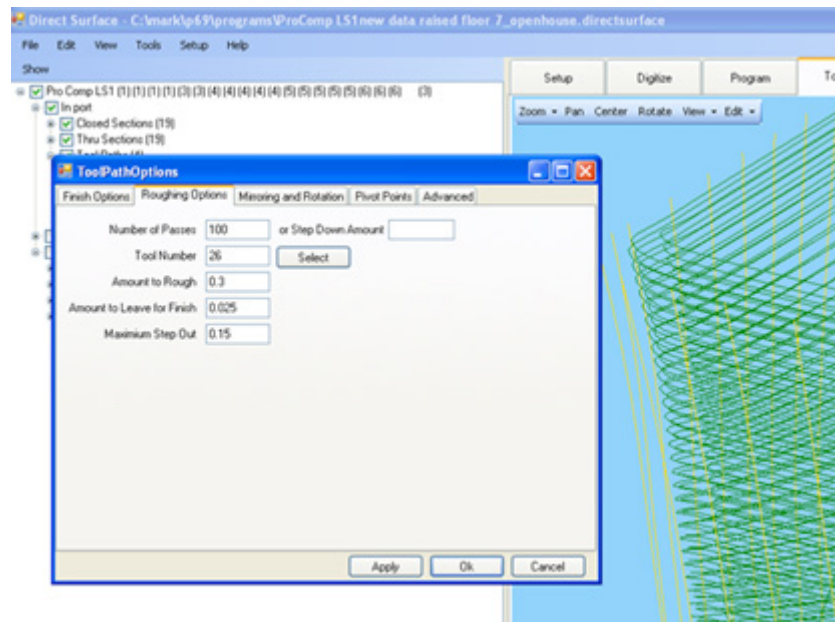

Once the tool path has been defined while under the “Program” tab the next step is to click on the “Tool Path” tab. At this stage the software calculates the proper pivot points and movements the machine will need to perform to define the tool path. The software will also warn you if there is a potential crash at a particular cross section.

To simulate the tool path set the appropriate tool active. In this case tool #26 is the tool we defined above in our tool path so this is the one we will set active

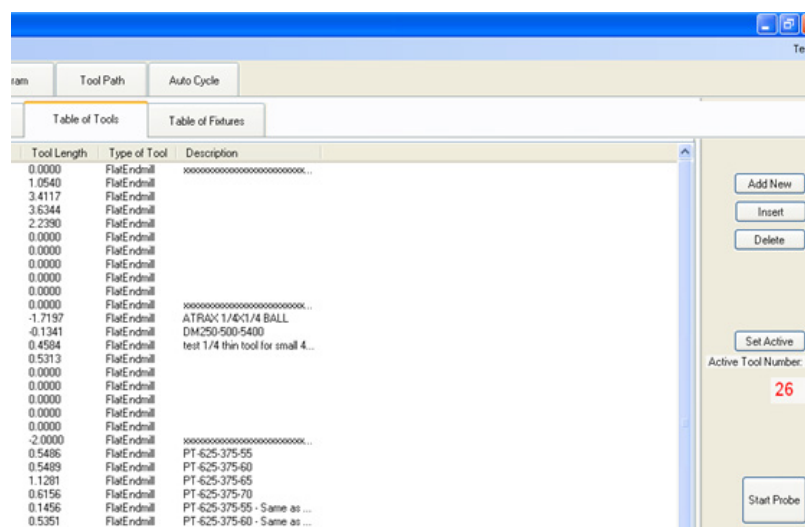



Next, click on 'Show' and be sure to have Solids and Tool checked. The example shows what a crash looks like in the graphics. The cutter geometry has been predefined in the software. The solid model of the port as well as a solid model of the cutter shows the operator where there are potential problem areas where the shank will hit the port. Before running a tool path this simulation should be thoroughly examined.

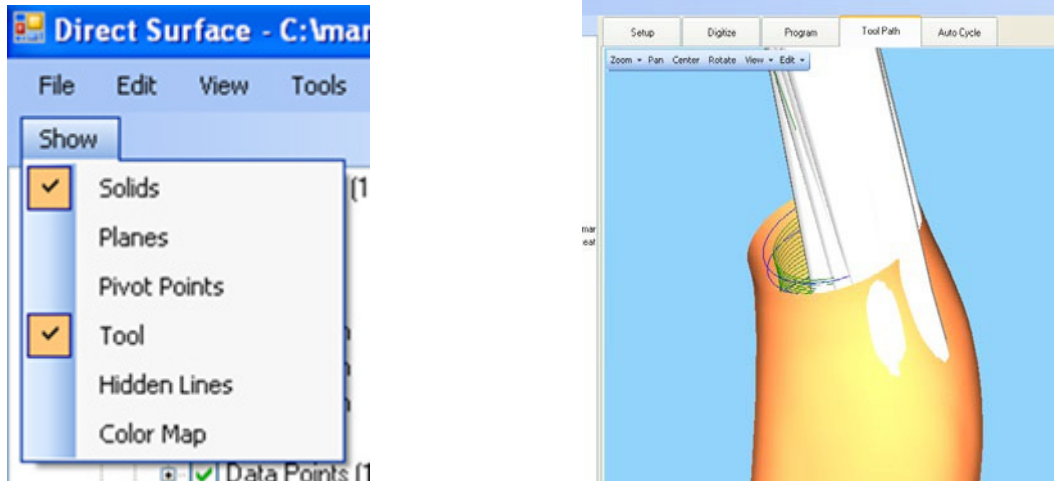

### Moving Pivot Points

If necessary you may have to move pivot points for certain cross sections if the shank of the tool is hitting where it is not supposed to. Start by isolating the cross section where the tool's shank is interfering with the port. Notice the cross section is highlighted in red in the graphics and is grayed out in the tree to the left.

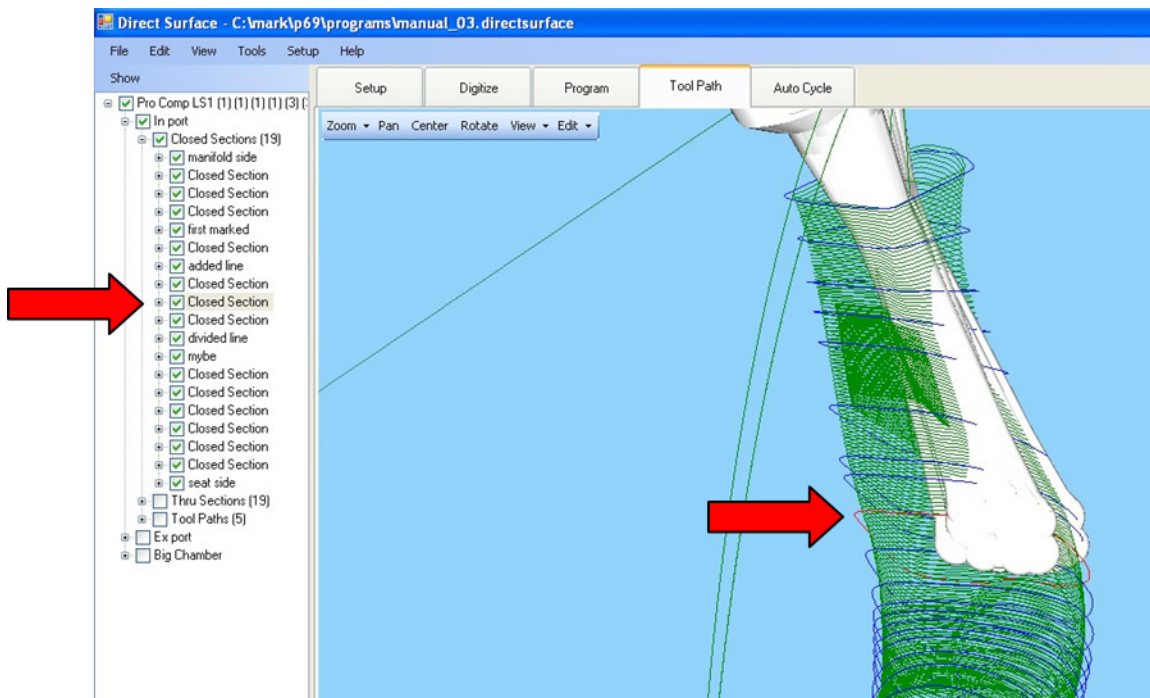

Open the Closed Section that you want to manipulate the pivot point by clicking on the “+” sign. Then open the ‘Pivot Points’ for this cross section. Double click on ‘Automatically Create Pivot Point’. A box will pop up that will allow you to manipulate the X, Y, and Z points of this pivot point. After changing a pivot point be sure to put a check in the “Locked” box

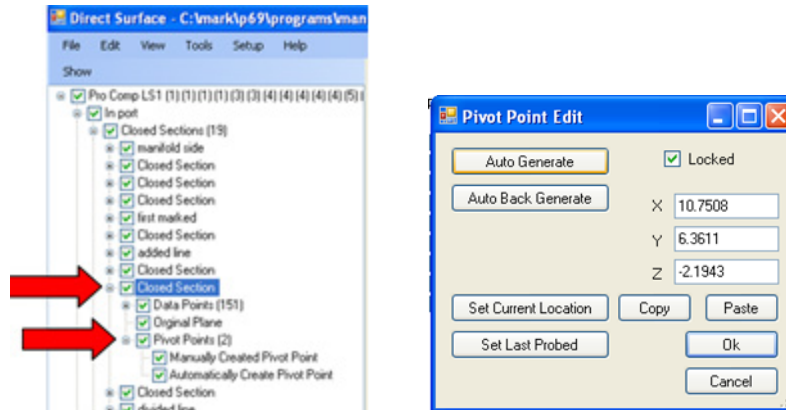

Make sure you click on ‘Show’ and ensure that the Pivot Points has a check by it. When you highlight the proper cross section you will see the pivot point show up as red. All the blue and green circles that you see below are associated with the closed sections located on the left side of the screen. Depending on the direction(X, Y, or Z) you want to move the pivot point this will graphically show you where the pivot point is being moved to.

Keep in mind when moving pivot points that X,Y, and Z sit normally when the A axis is located at A zero. In other words when A is positioned at zero X positive is to the right, Y positive is facing to the back of the machine and Z positive is straight up. As the A axis rotates so do Y and Z. Let’s say for example the A axis rotates 90 degrees so that now the combustion chambers and fixture plate are facing the back of the machine. The Y and Z have rotated along with the head. In this instance the Z positive is now facing the back of the machine and the Y positive is facing toward the table. Think of it as fastening an X,Y,Z symbol on the top of the fixture plate when A axis is at zero and combustion chambers are facing up. As the head rotates around the X,Y,Z symbol rotates with the head. Once the pivot point has been moved the tool path automatically regenerates and you can simulate the cutter path to ensure that you have addressed tool interference. If not, the pivot point may need to be moved again

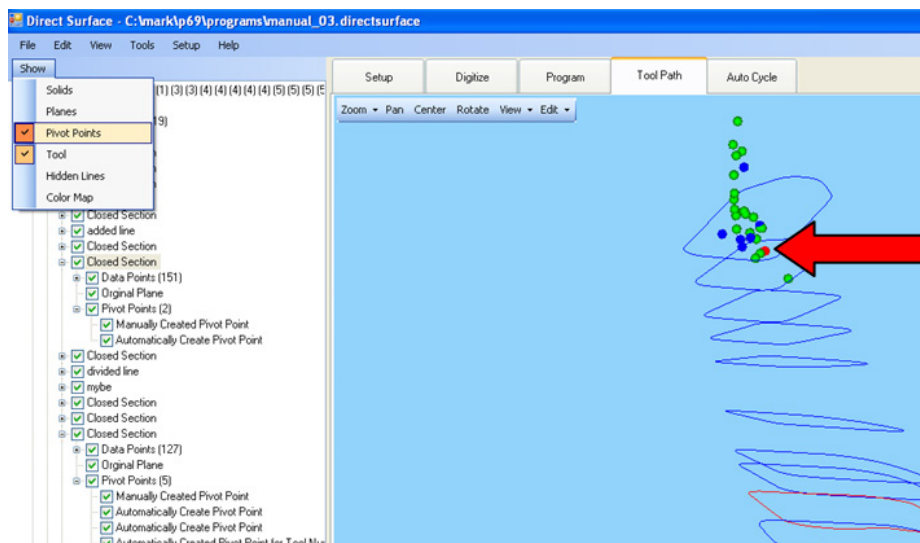

## Loading and Running a Tool Path

Once you are satisfied with the simulation of the tool inside the port it is now time to run a tool path. Start off by clicking on the 'Auto Cycle' tab. Also, make sure that the 'Select Tool Paths to Run' tab is selected down at the bottom of the page.

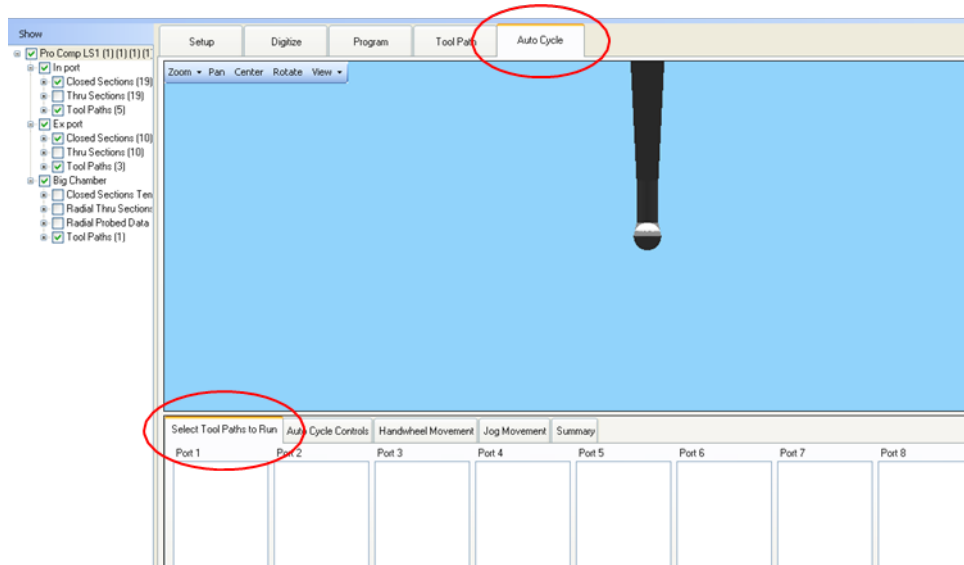

Next, open up the tool paths for the ports and or combustion chambers that you would like to run. In the example below you will see that the tool paths from the intake port have been opened up by clicking on the plus symbol to the left of the Tool Paths (5).

The next step is to drag and drop the tool paths down to the appropriate ports. In the example below the 'Seat Finish' and the 'Manifold Rough & Finish' have been imported into port #1. This tool path is now ready to run

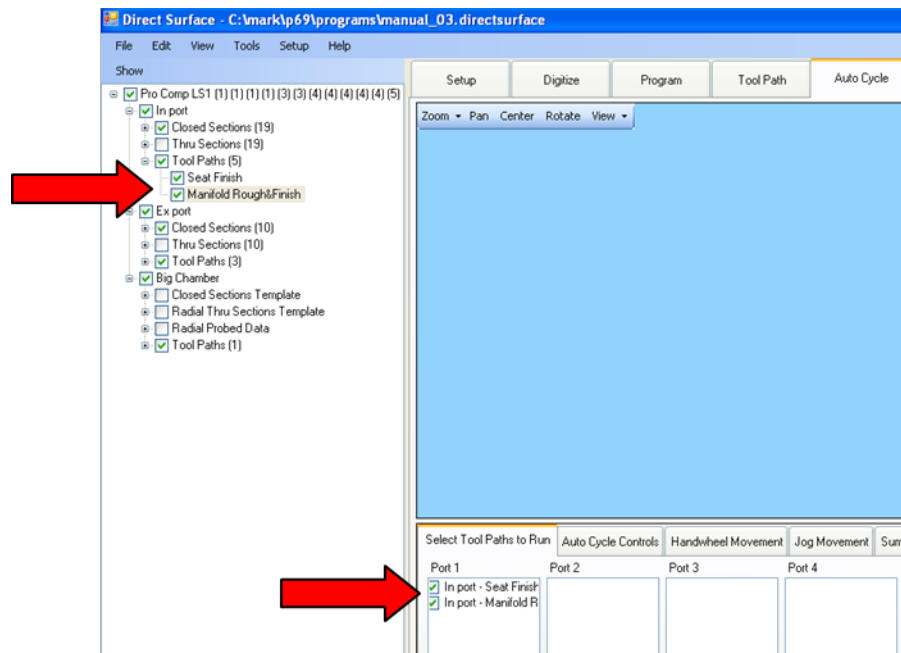

Next click on the 'Auto Cycle Controls' tab to start your program. Notice that the port number is highlighted either green or yellow. Having the port lit up in green means that these are the ports that will be machined. In the example below Port 3 was used to digitize from.

You will want to add a value of zero here. Simply add the bore spacing in ports 1, 2, and 4. In this example we have a small block Chevy with a bore spacing of 4.4. Ports to the left of port 3 are negative and ports to the right of 3 are positive.

Select Tool Paths to Run	Auto Cycle Controls	Handwheel Movement	Jog Movement	Summary				
CYLINDER HEAD PORTS								
	PORT 1	PORT 2	PORT 3	PORT 4	PORT 5	PORT 6	PORT 7	PORT 8
X	-8.8000	-4.4000	0.0000	4.4000	0.0000	0.0000	0.0000	0.0000
Y	0.0000	0.0000	0.0000	0.0000	0.0000	0.0000	0.0000	0.0000
Z	0.0000	0.0000	0.0000	0.0000	0.0000	0.0000	0.0000	0.0000
COOLANT		Distance To Go	0.000	Feedrate Override	0.00	START AUTO CYCLE		

The diagram below shows the actual tool path the cutter will follow. You will notice that there is a green arc that moves from the intake part of the port around to the seat side of the port. This represents the movement of the tool when it completes the first half of the port, then pulls out, then rotates around to the opposite side of the port to begin its operations where it will join in the middle of the port.

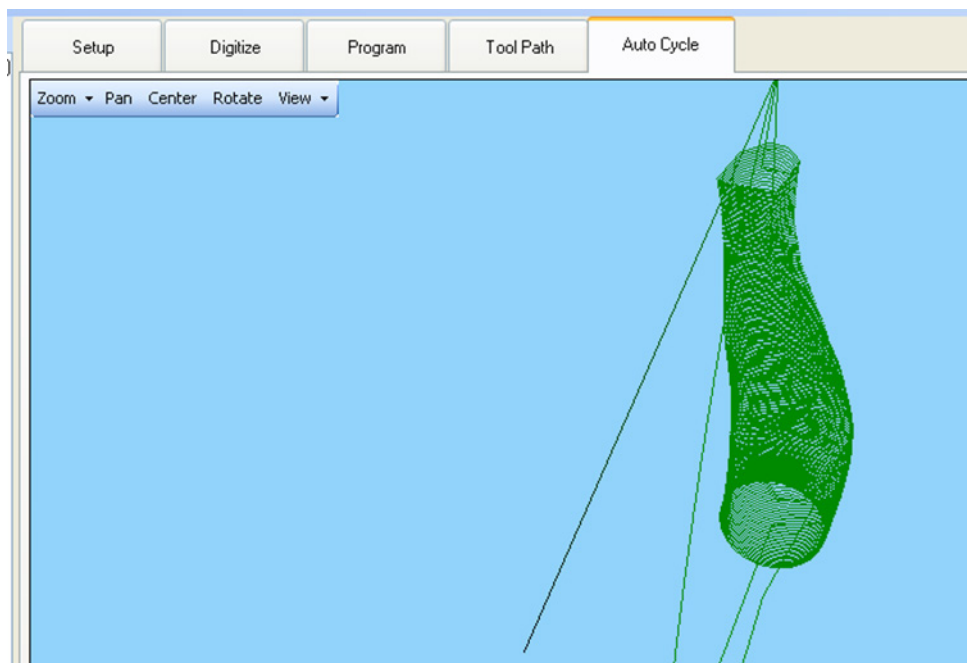

At this point to start the tool path cycle simply click on 'Start Auto Cycle'. A message will come up verifying that you have the correct tool loaded up. If you do not have the correct tool click on 'Change Tool'. If you do simply click 'Okay'

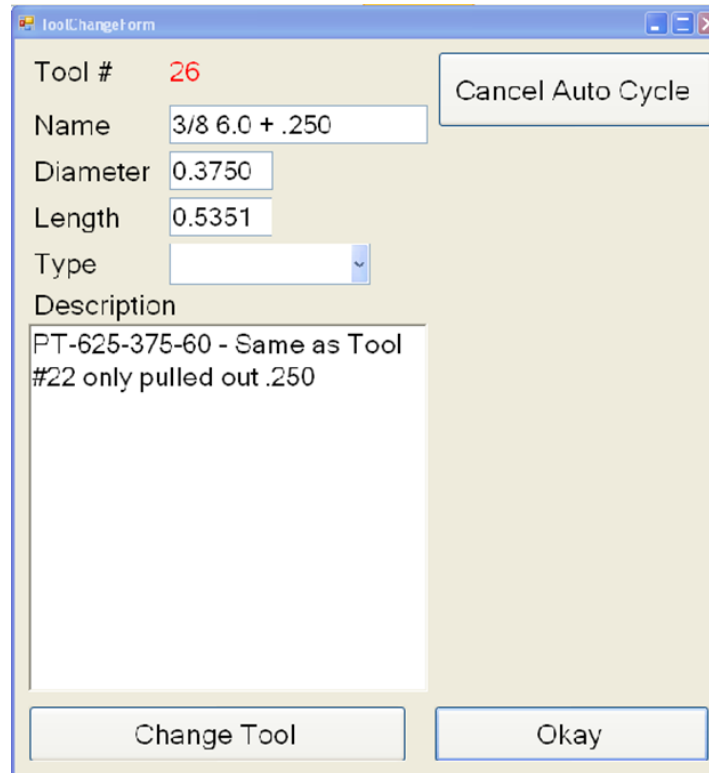

The screenshot shows a dialog box titled "ToolChangeForm". It contains the following fields and buttons:

- Tool #**: 26
- Name**: 3/8 6.0 + .250
- Diameter**: 0.3750
- Length**: 0.5351
- Type**: (dropdown menu)
- Description**: PT-625-375-60 - Same as Tool #22 only pulled out .250
- Buttons**: "Cancel Auto Cycle" (top right), "Change Tool" (bottom left), and "Okay" (bottom right).

After clicking OK this message will appear. Once you click 'OK' at this point your program will begin.

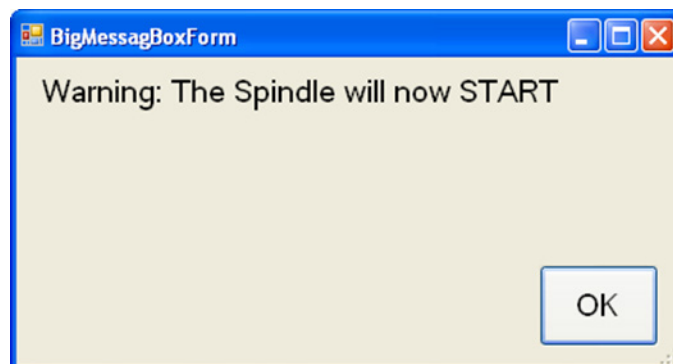

It is very important to acknowledge that after clicking on OK that the machine becomes active and will move quickly to its first position. Especially when you are first proving out a head the operator needs to keep their hand on the hand wheel and E-stop button. While the machine is in motion if you turn hand wheel counter clockwise it will slow the feed of the machine all the way down to zero inches per minute. This allows you to ease the cutter into the work and avoid potential crashing due to incorrect fixture or tooling offset or any other variable that could be overlooked

## Creating A Combustion Chamber

To create a combustion chamber right click on the head name then left click on 'Add a New Chamber' like shown below. You will see 'Chamber' appear just under the intake and exhaust ports

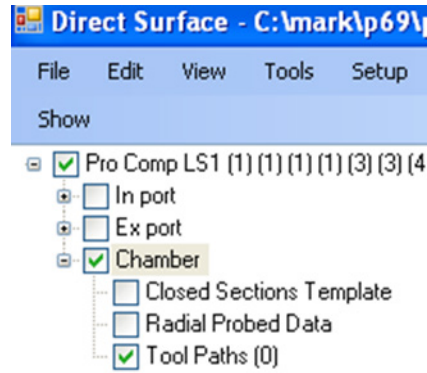
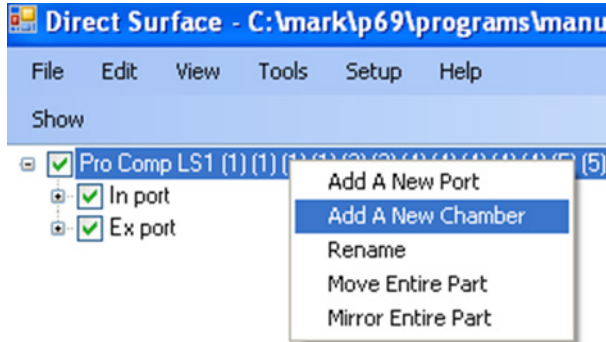



## Adding Planes

The first step in creating a combustion chamber is to establish two planes. The first plane will be established at the deck surface of the head. You will pick up three points on the deck to define this plane. The second plane we will define is the angle of one of the valves. Note that it does not matter which valve you will use. To define a plane on the valve you will need to collect three points. In the photo below there are arrow showing approximate positions to establish the two planes.

The three points that need to be collected to define the deck plane surface

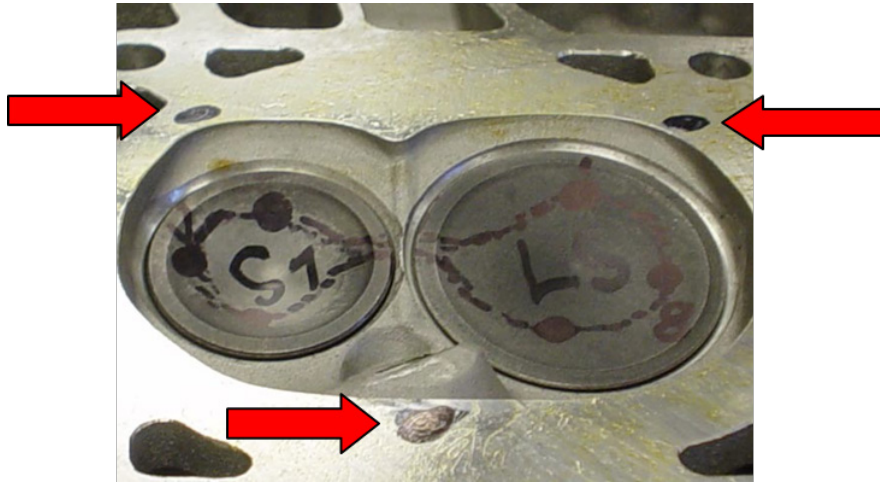

The three points that need to be collected to define the valve plane surface

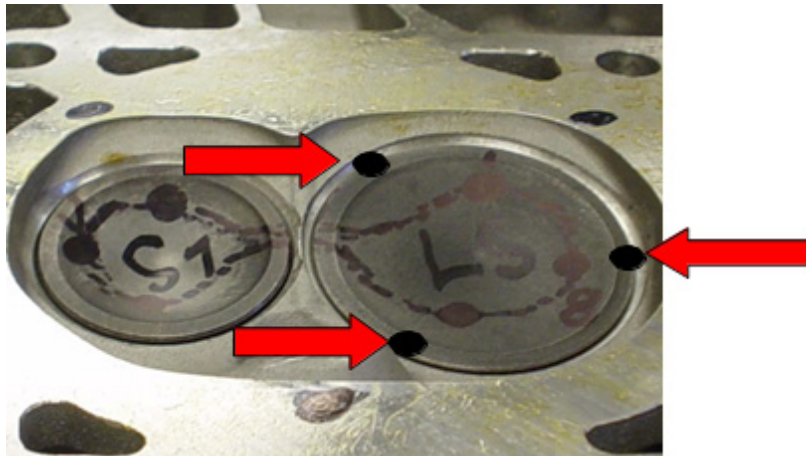

## Defining the Planes

To define the two planes in the software start off by right clicking on 'Add New Planes for Probing'. It will tell you that you are using a certain tool number to collect the points. Make sure that you have set the proper tool set as active. This can be found in the table of tools under the setup tab. Whatever probe you are using set this tool number to active.

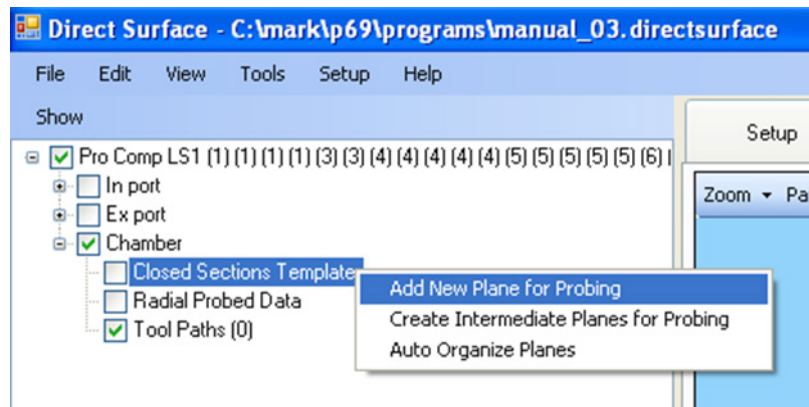

This message will come up letting the user know which tool is set to active

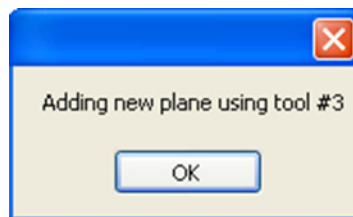



## Defining Deck Plane

### First Plane

After clicking on 'OK' an Add Plane Wizard will appear. You will enter three points into the wizard the same way we did when you defined the planes for the intake and exhaust ports. You will start by collecting 3 points on the deck surface like shown below.

Dial the probe down in Z until the indicator light changes from green to red then dial it back up in the positive z direction until light changes back green. Then in the Add Plane wizard click on 'Set Last Probed' to collect point's one, two, and three. Remember, it takes three points to define a single plane. Note the position of the probe relative to the chamber's edge. The digitizing process begins in the center of the three points.

POINT 1



POINT 2



POINT 3

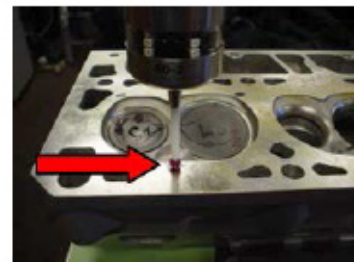

## Second Plane

Just as you did with the deck plane you will again start by right clicking on 'Closed Sections Template' then left click on "Add New Planes for Probing." Since you set the probe active already this will remain active until you change it. You should see a message appear that says "Adding new plane using tool #3" (If you are using tool #3 as the probe you want to use to digitize). You will repeat the same process that we used in creating the deck plane only this time you will use three points on the surface of the valve. See pictures below

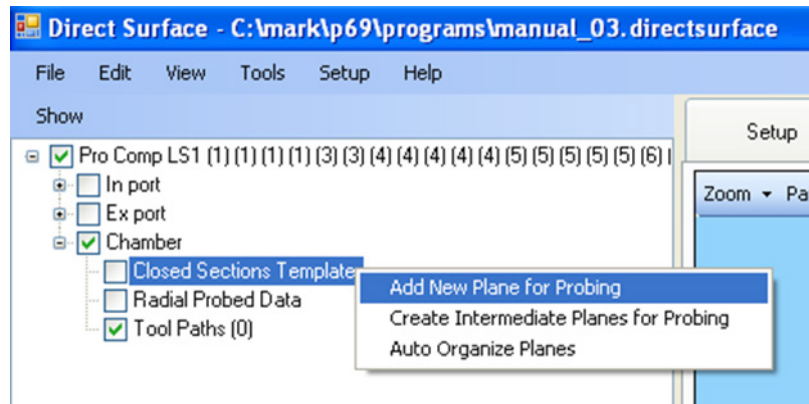

This message will come up letting the user know which tool is set to active

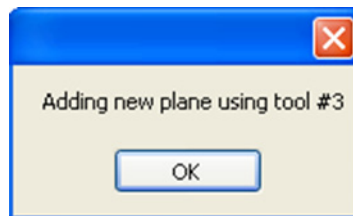

After hitting OK an 'Add Plane Wizard' will appear again. You will collect three more points to define the valve plane.

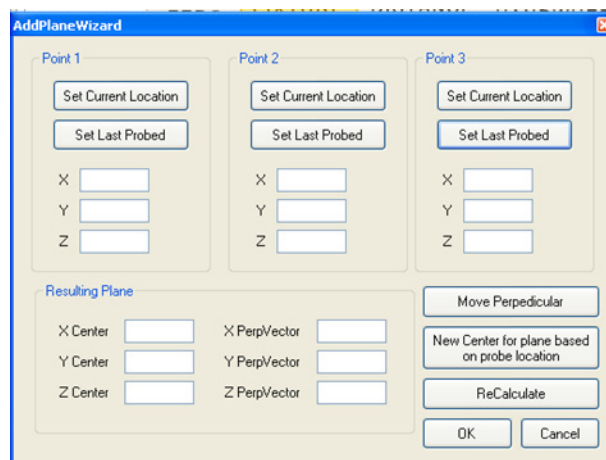

POINT 1

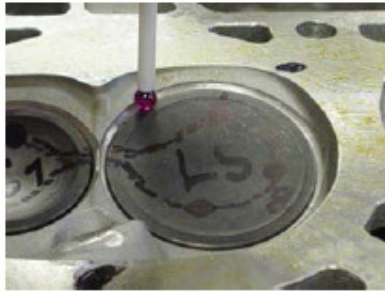

POINT 2

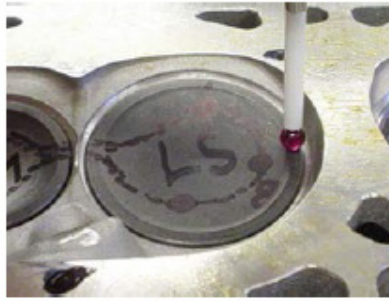

POINT 3

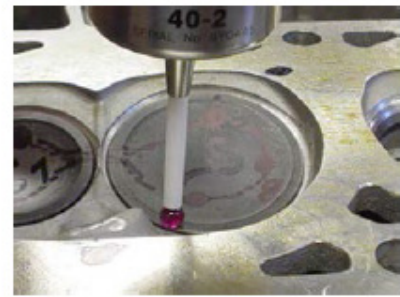

Once you have collected the three points you can verify that you have created the two planes by clicking on the 'Digitize' tab. If all you see is blank space ensure that you have clicked on 'Show' and that you have a check by 'Planes'. You should then see your newly created planes in the graphics view below.

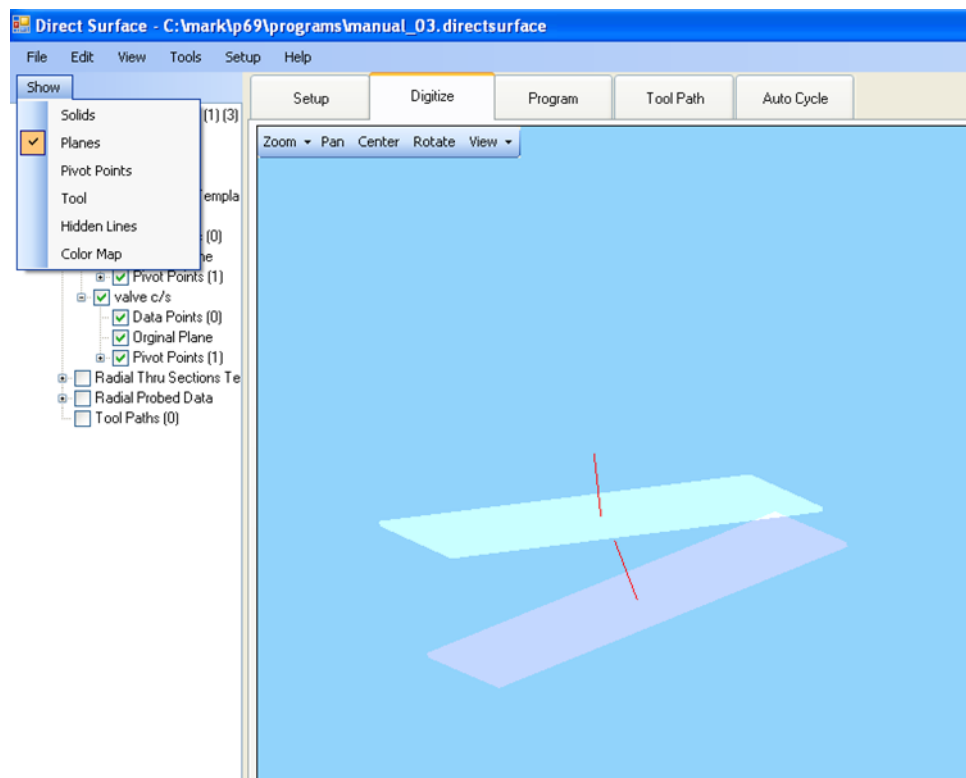

The next step is to move the deck plane in 'Z' toward the valve plane at a value of .118. The reason this is done is because when we picked this plane up we do it with the tip of the probe and not the side of the probe.

The plane represents where the center of the probe will move to when it begins the probing process. Note that when the cross sections are defined the deck surface is done automatically. The valve cross section will be done manually by recording several points.

## Moving Deck Surface

Before we begin digitizing for the cross section at the deck surface we need to move the plane down toward the valves. You will notice that there is a red line one side of the plane. This represents the positive direction. In the example above you will see the valve plane is on the opposite side of the red line. This means that you will move the plane negative (.118). Keep in mind that it will not always be a negative number. It can vary depending on how the software calculates the plane.

Another way to analyze the direction you want to move the plane is to click on show and check 'Tool' so that you can visually see the probe in the graphics view. Physically wheel your probe down so that the midpoint of the ruby is sitting at the deck surface. When you drop the plane down .118 you will see it move in the graphics. You can verify that the plane should be going through the tip of the probe exactly through the center of the ball. If it does not, you most likely moved the plane in the wrong direction. In this case you would have to double the .118 to .236 and change the sign.

To move the deck surface, open up the deck surface plane that has been created. Notice in the example below that I renamed the planes to "deck c/s" and "valve c/s". The c/s stands for closed section. Next, double click on original plane. This will re-open the plane wizard. Next, click on move perpendicular. It is in this field where you will enter the value to move the plane. In this case it will have a value of (-) .118. This is approximately half the diameter of the probe tip. Actual tip size is .236 and half of that value is .118.

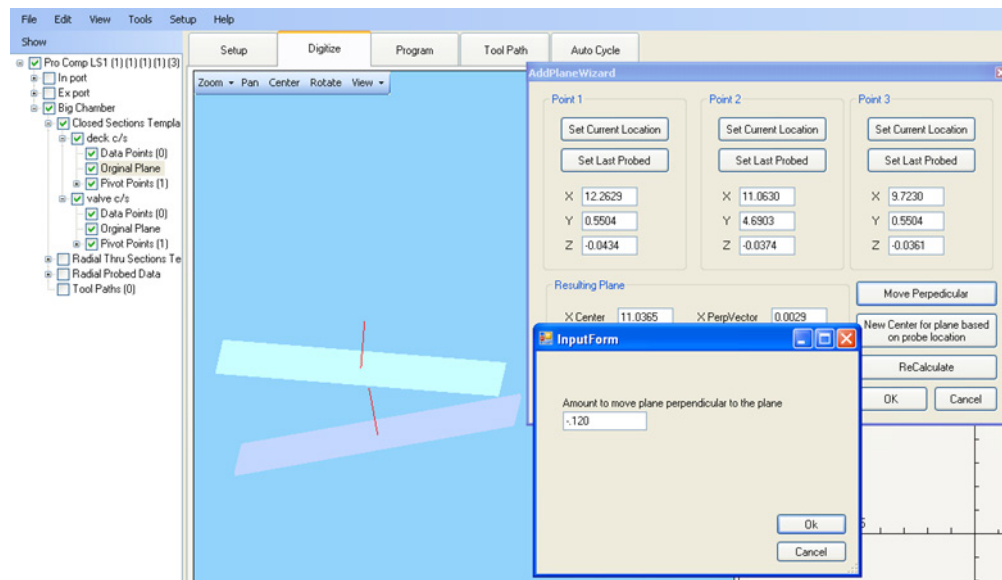

## Create Cross Sections

After creating two planes you must now define the cross sections that are essentially the inner and outer borders in which the probe will be contained in. We have to define some parameters in which the probe knows where to move. To define the cross section at the deck surface you will simply highlight deck c/s then click on probe single plane. Make sure that the probe is positioned approximately one inch above the chamber you want to probe. Also make sure that you have the Digitize tab picked.



Once the deck surface cross section has been probed automatically you should see something similar to what is shown below. Again, this is simply an outside border that the probe will move to when we begin digitizing the entire combustion chamber

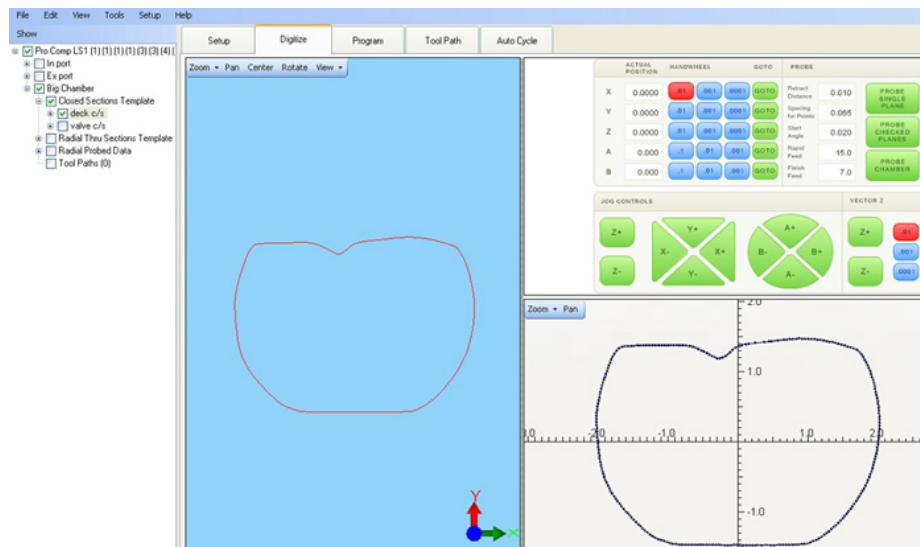

## Inside Border

After the outside boarder/cross section has been define it is now time to define an inside boarder for the probe to move to. This is a bit more of a manual process in the way points are collected. The first thing to do is to highlight the cross section that we want to collect points for. In this case we want to highlight “valve c/s” as shown below. What you will do here is to collect a series of point (8 to be exact) in the form of a figure 8. You should have valves inserted at this point. Next, you will want to turn on the probe by clicking on the “Setup” tab then table of tools. Inside of the table of tools there is a button labeled ‘Start Probe’. Click on this button and you will see the probe become activated. Click back on to the “Digitize” tab and we will begin collecting points for the figure 8.

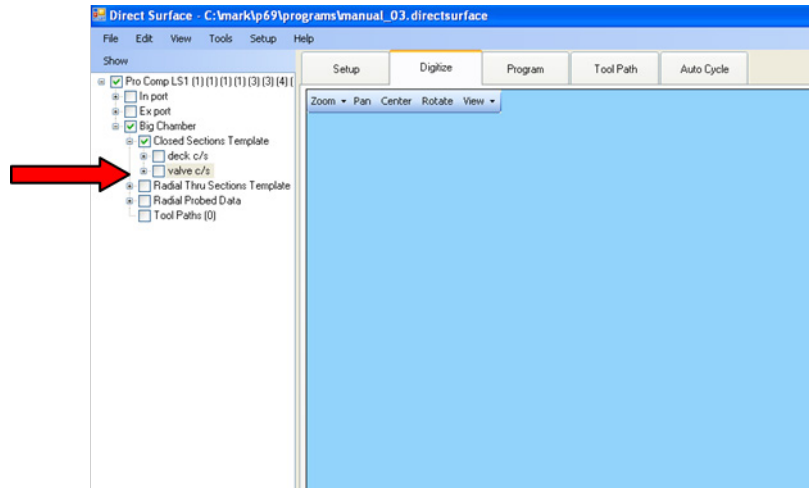

With the probe on there are 8 points that you need to collect and manually record into the software. The eight points are shown in the picture below.

To collect the points hand wheel the probe until the tip just makes contact with a point. You will see the probe change from green to red once the tip makes contact. For each point you will click on ‘Tools’ then ‘Record Point’. (To make it easier you can just simply hold down the control key and press r to record the point) When your are done you will have 8 points collected.

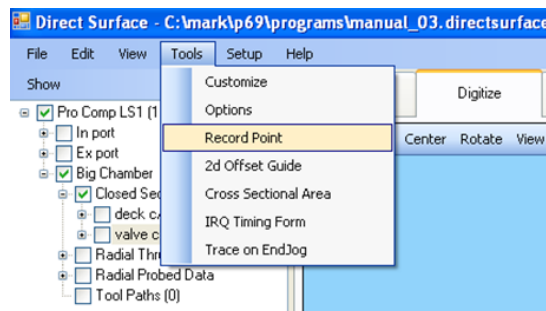
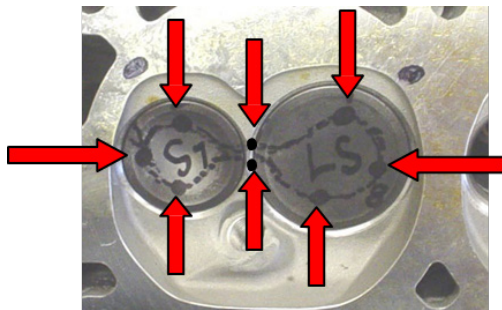



POINT 1

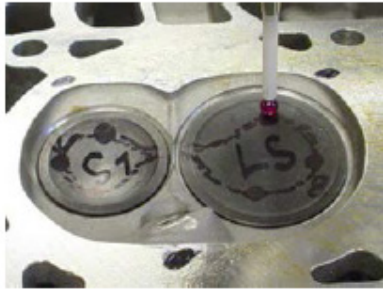

POINT 2

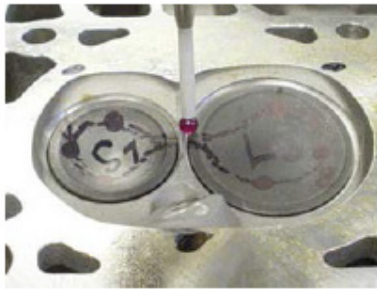

POINT 3

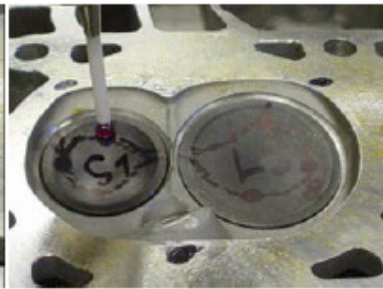

POINT 4



POINT 5

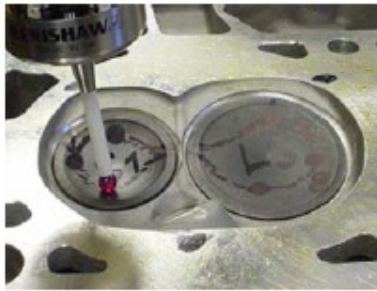

POINT 6

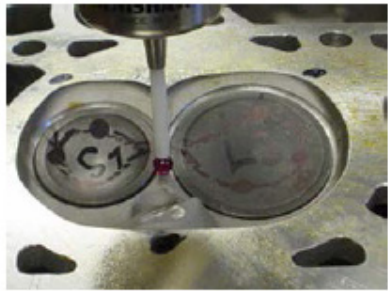

POINT 7



POINT 8



After you have recorded all eight points you should have something that looks like the picture below, showing on the graphics of the software. Make sure that your 'Program' tab is depressed and the "valve c/s" has been highlighted.

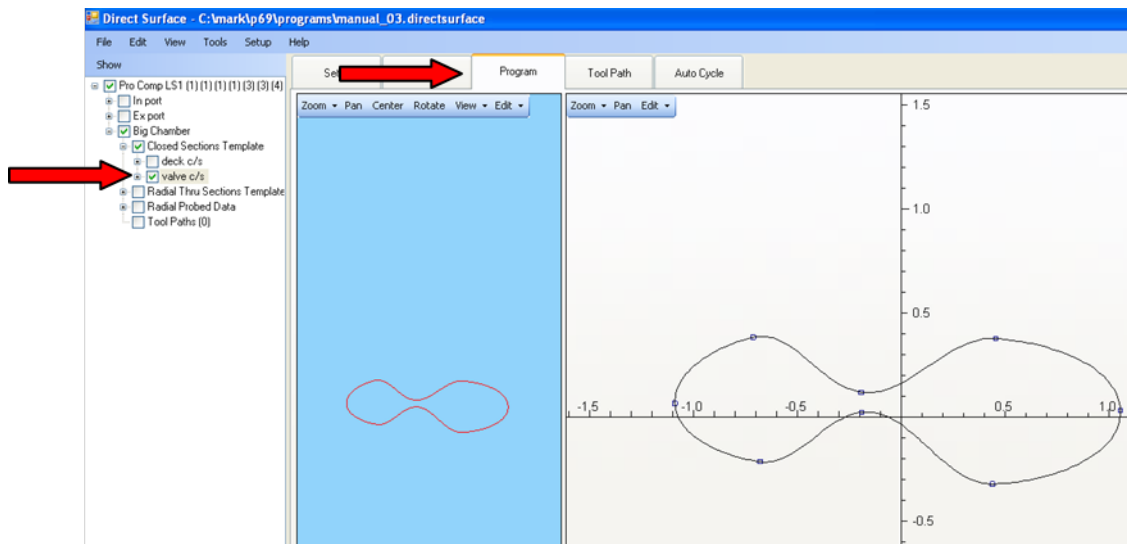

The next step is to manually enter extra points around the figure 8 so that it will give you more control of the shape. Do this by right clicking on the contour itself. The figure below shows that approximately 12 points have been added. Next, use your left mouse button to drag the points around to obtain the shape that you want.

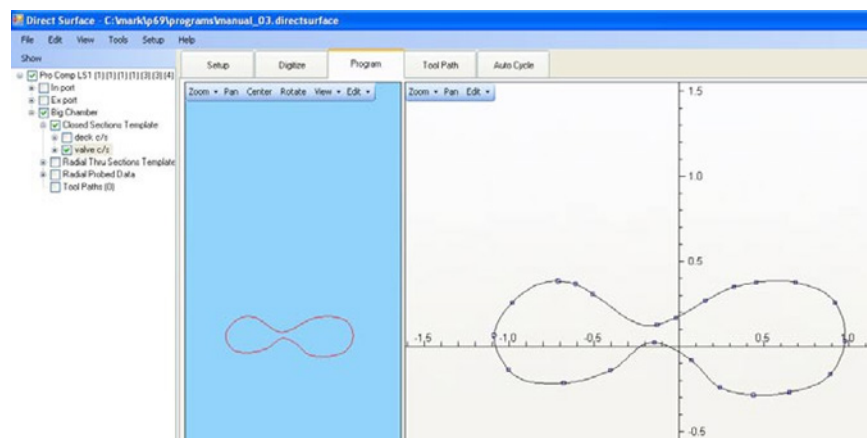



Now, check on the deck c/s box and you will see both contours in the graphics window. At this point we have created two boundaries. These containment boundaries define not only where the probe will digitize but also where the tool will cut when a tool path is created.

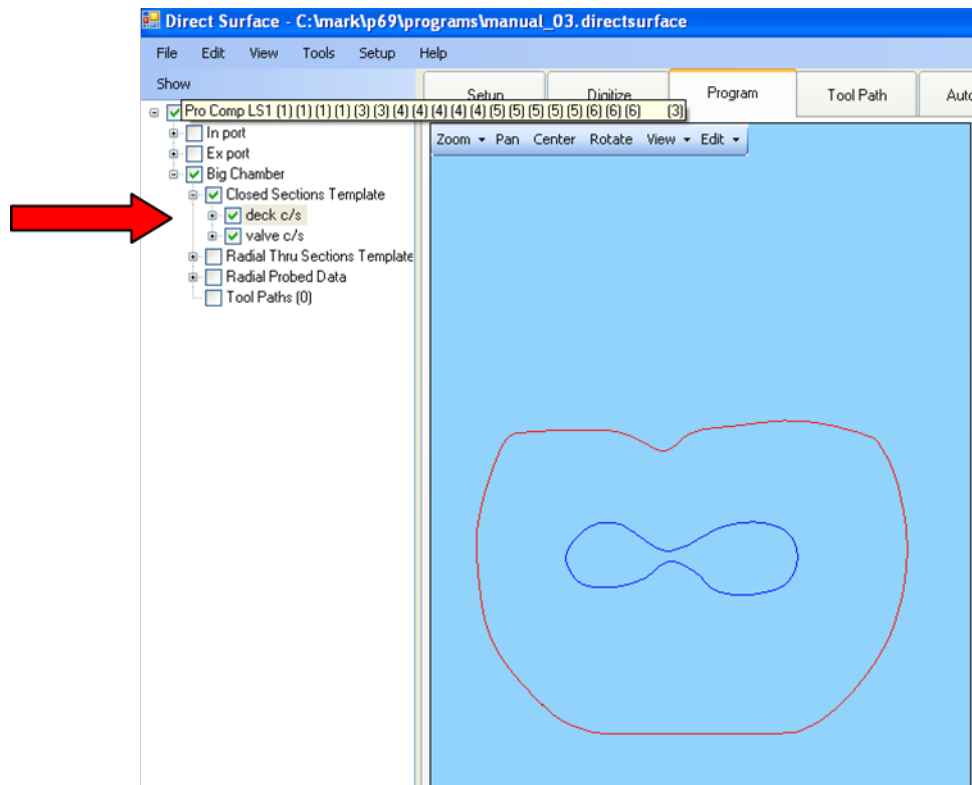

The next step is to create a radial template which is evenly spaced in between the two cross sections. To accomplish this right clicking on the Chamber then left click on "Create Radial Template".

An input box will come up and you will enter a value which controls the step over amount for the probe when it begins its digitizing process.

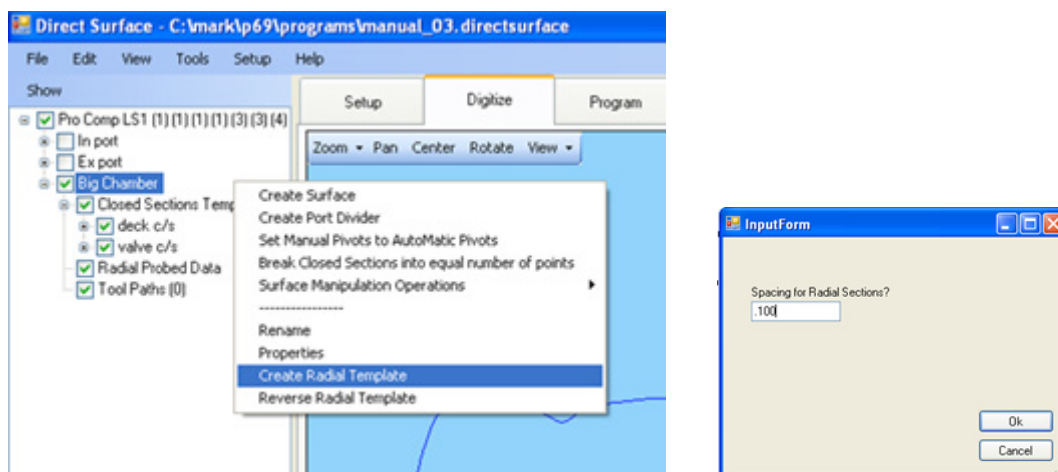

To view this graphically click on the 'Program' tab and look in the graphics view. Sometime you will find that the graphics are positioned outside the viewing window and you will have to roll the mouse to zoom in and out to bring the graphics back into view. Notice the yellow lines below that are in between the boundaries that were created. You will notice the spacing is approximately .100 when look near the figure 8 cross section. This is the value we input for the Radial Template above. Note that when a radial template is created a surface will be generated from this. Do not confuse this with the surface that will reflect the actual shape of the chamber. This surface only represents the path or containment for the probing process

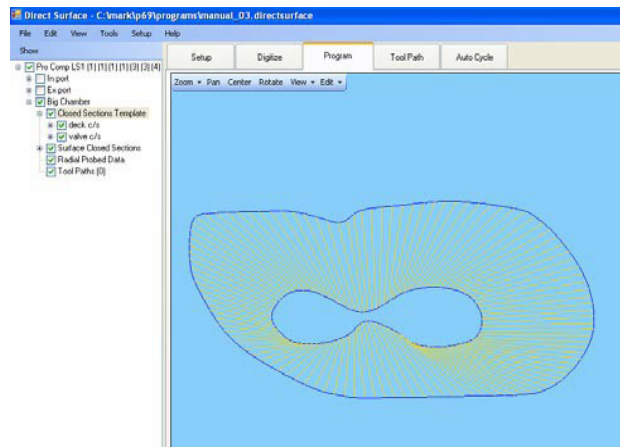

The next step is too active the automatic probing cycle. Make sure that the "Digitize" tab has been selected. Position the probe approximately three inches above the chamber that you want to probe then simply click on the 'Probe Chamber' button.

The probe will start on the inside portion of the chamber and work its way up to the deck surface. The chamber can take an hour or more until completing the digitizing process. Ensure that the valves remain set in the guides and that you have plugged the spark plug hole.

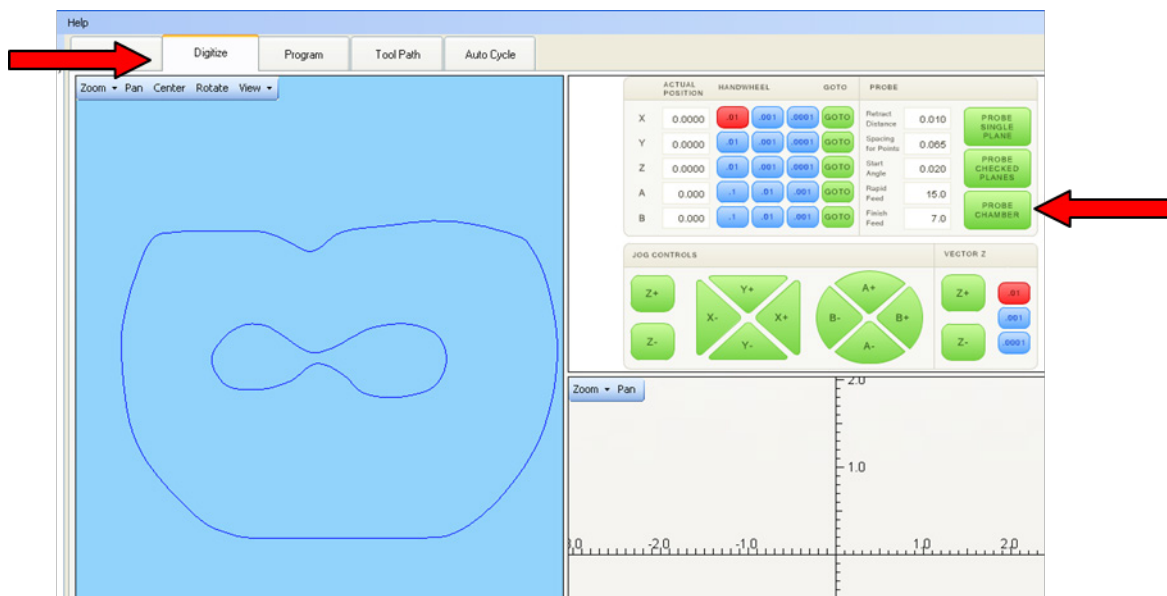

After probing completes the next step in the process is to create a surface. Simply right click on chamber name then left click on Create Surface.

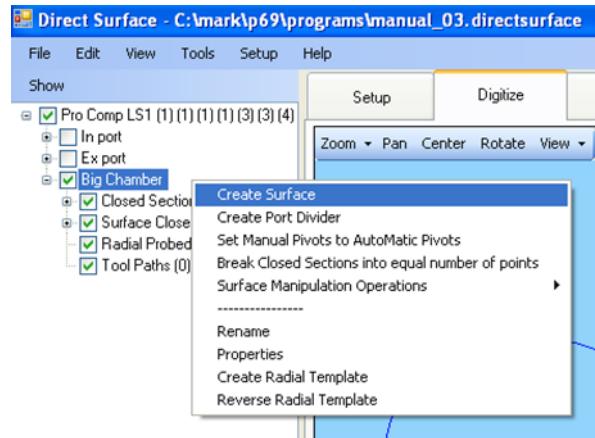

To view the surface be sure to have Solids checked which is found under the "Show" button

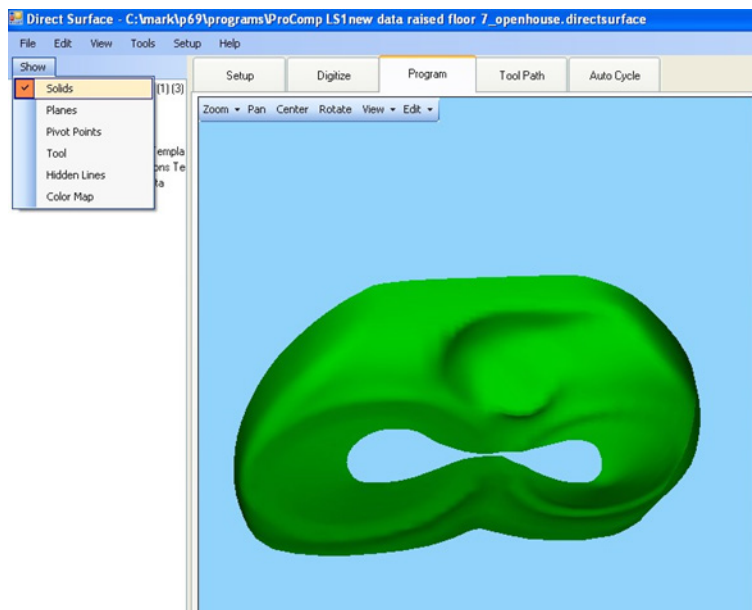

## Creating a Tool Path

Once we have a surface created for the combustion chamber that you are happy with the next step is to create a tool path.

The chamber will be cut in three axis so to do so we will need to delete the pivot points for the top and bottom planes, before we are able to create the tool paths.

Under chamber open up “closed sections” and then open up the “key closed sections” which are two one for the top and the other for the bottom section.

Under each of the “key closed sections” click and highlight the “pivot points” then press the delete key on the keyboard. It will ask if you are sure you want to delete it, chose “yes”

To create a tool path for the chamber start by right clicking on ‘Tool Paths’ found under the chamber name as shown below.

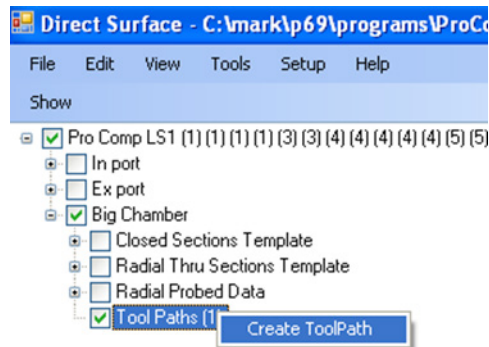

Double click on the Tool Path name that was created as shown below. Enter all of the pertinent information such as Number of Passes, Tool Number, Additional Oversize Amount, and Initial Feeds and Speeds.

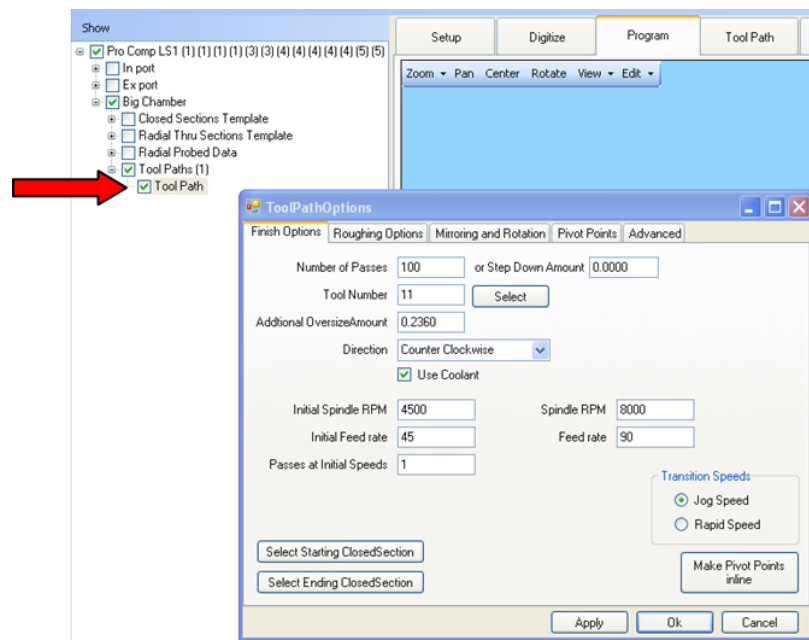

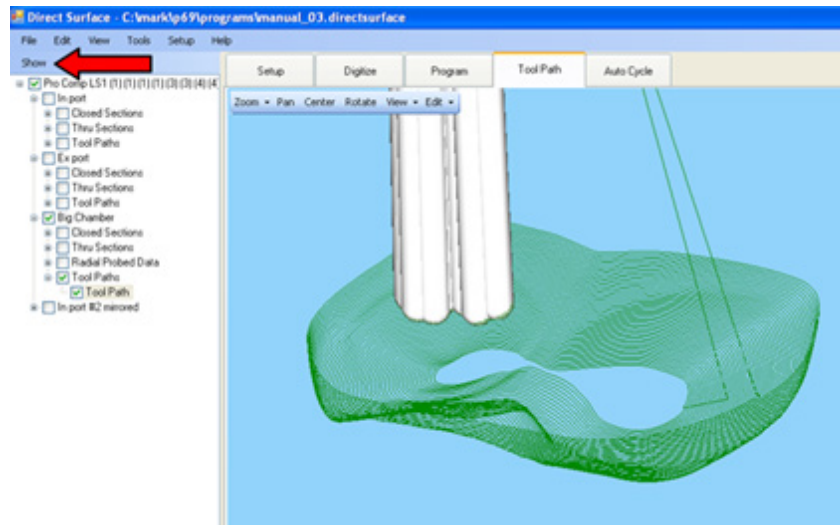

Drag Tool Path into the ports that you want to cut. There are cases where you may want to cut all of the chambers the same. There are also circumstances where you want to run a mirror tool path in two of the ports. We will get into mirroring later on. For now simply drag and drop the combustion chamber into the ports you want as shown below. In this case you would drag and drop the combustion chamber into the port locations just as we did with the ports above. If all of the chambers are the same drag the tool path into each of the ports like you see below

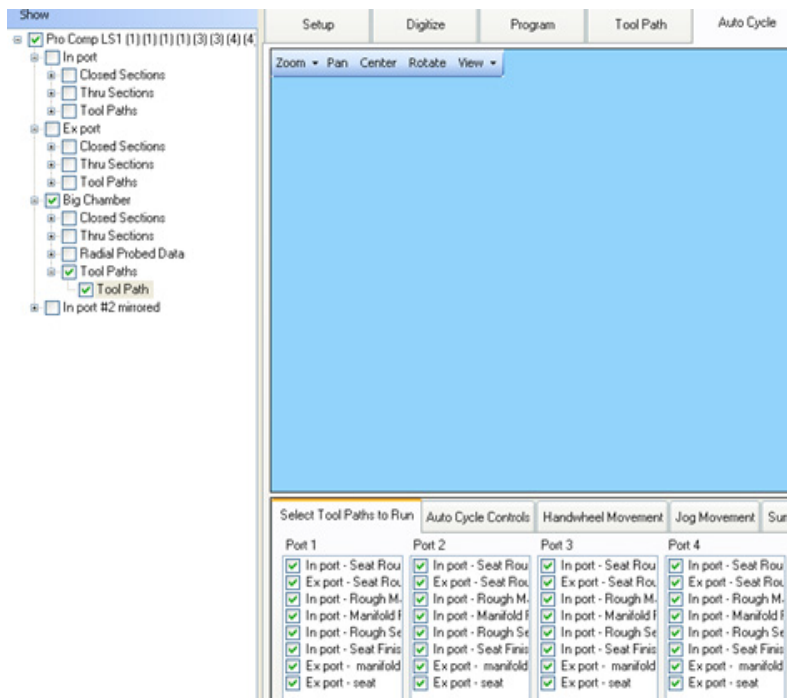

## **Mirroring**

On some heads you will have to mirror the ports or chambers depending on the application that you are working on.

### **Mirroring Tool Path**

After you have all your tool paths created for the chamber and ports, with all feeds and speeds that you want to cut with, just simply right click on the “tool path” tab under either the port or chamber section and then click on “Duplicate All Tool paths as Mirrored Toolpath”

A window will come up and ask to input the offset to mirror around X, It's the distance to the center of the chamber, for example in a SBC head the center of the chamber is 2.4 around the X axis. Which X is located off of the left dowel pin.

Do the same for the chamber tool path and then you will have the mirrored tool path created under your original tool path.

When setting up the tool paths on the desired cylinder, drag the mirrored tool path on the cylinders that are mirrored from the original digitized chamber and ports.

## Backing Up and Restoring Block Profiles

This section will explain how to back up and restore the operator created block profiles for DM controlled machines for archival purposes or to transfer to a different machine.

First step is to open your file browser and locate the RottlerWPF file on the C disk drive.

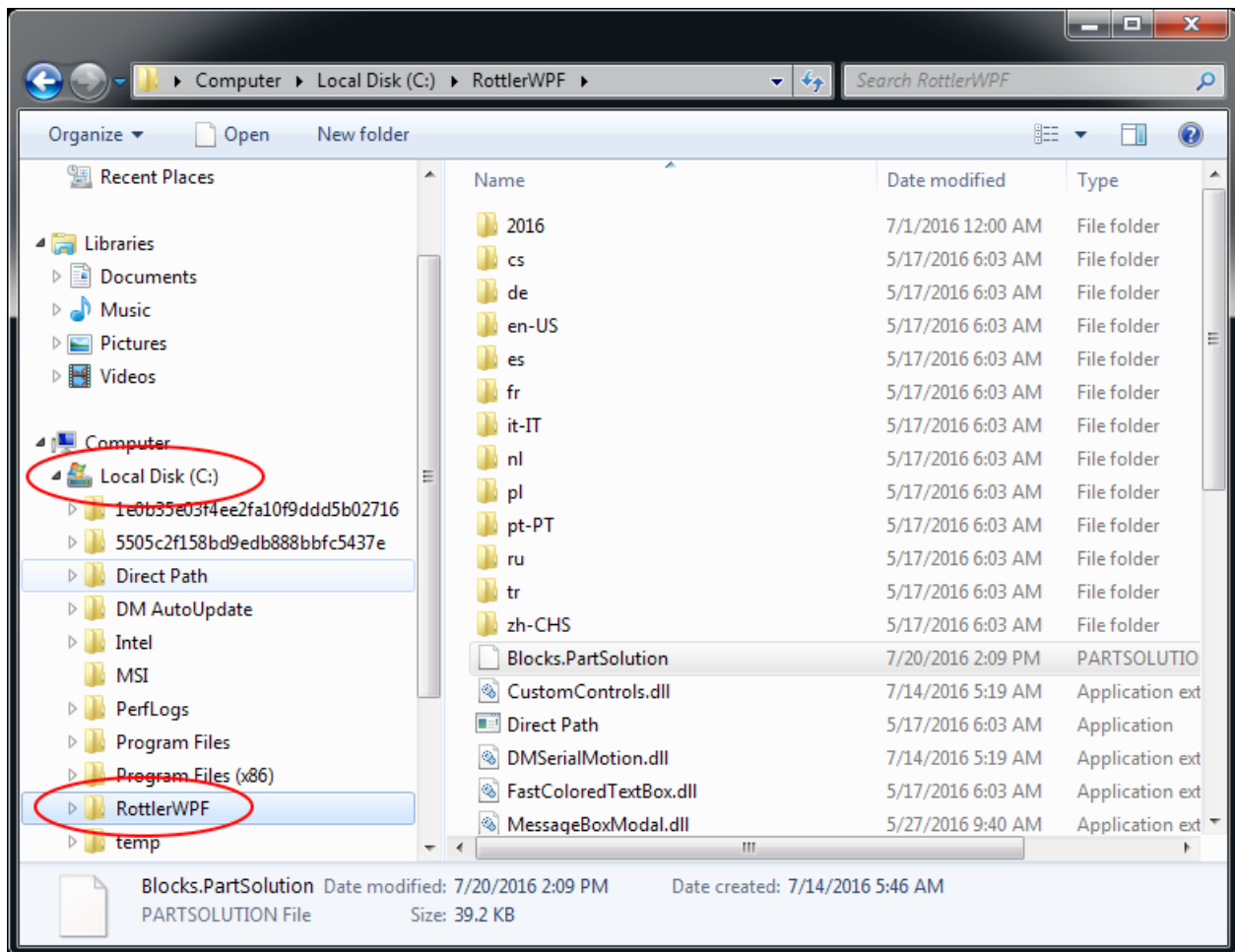

The next step is to plug in a flash drive to an open USB port





The following pop up box will appear on your screen.

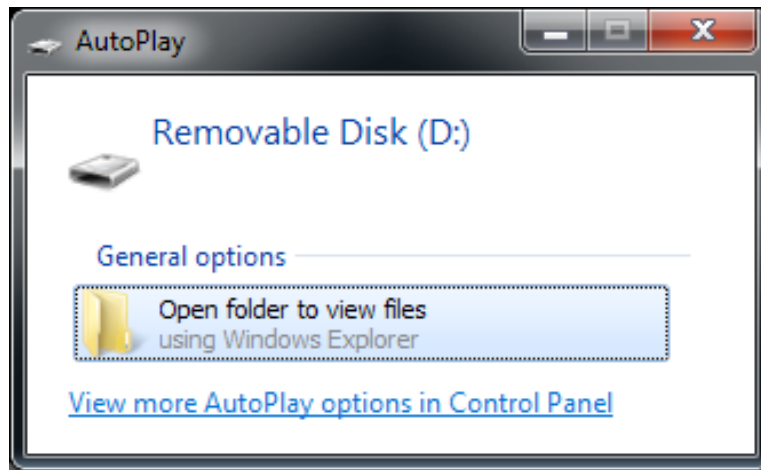

Click on the Open folder to view files option and the following screen will appear. This is the contents of the flash drive you just plugged in.

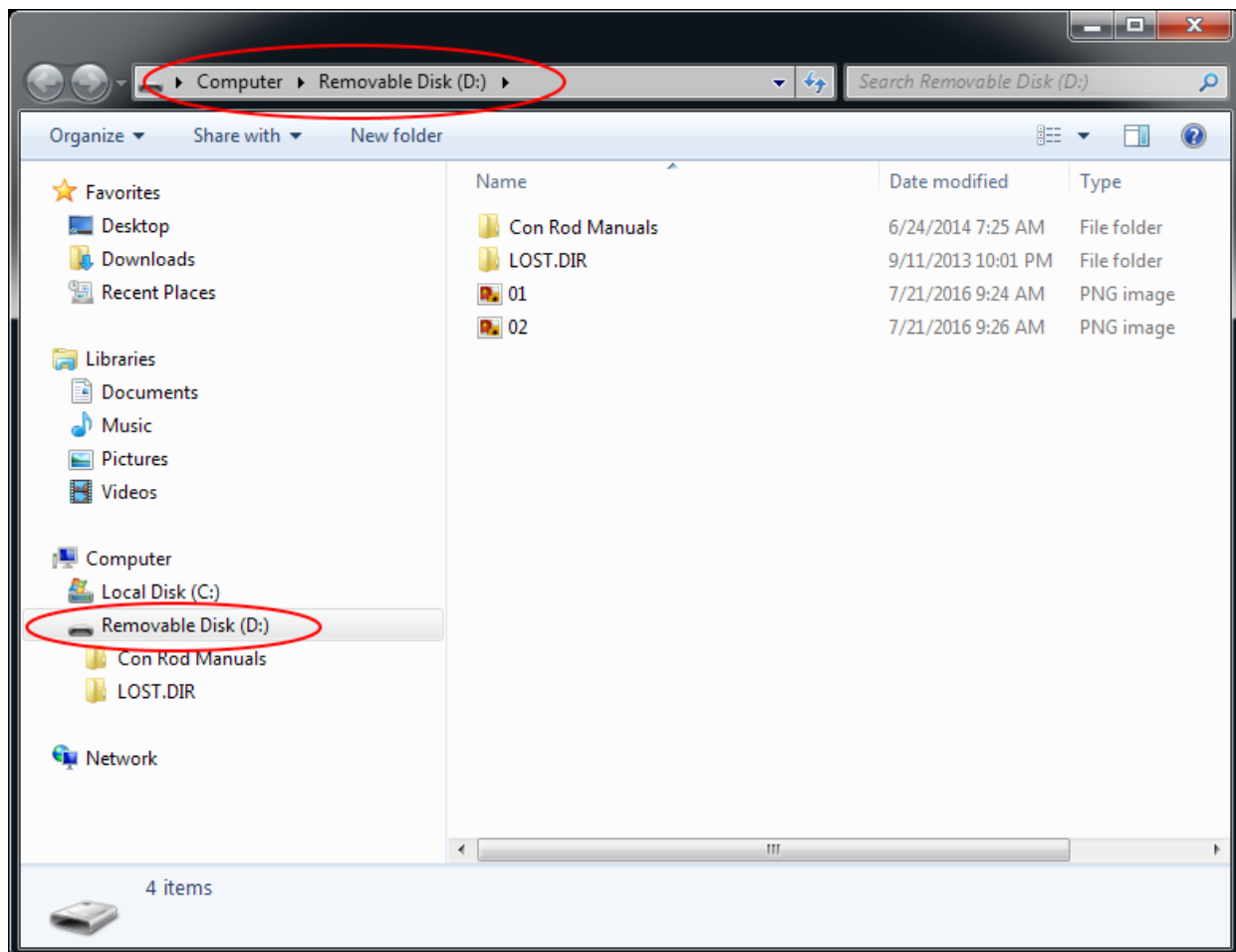



Next resize and arrange both file browsers so that they are side by side.

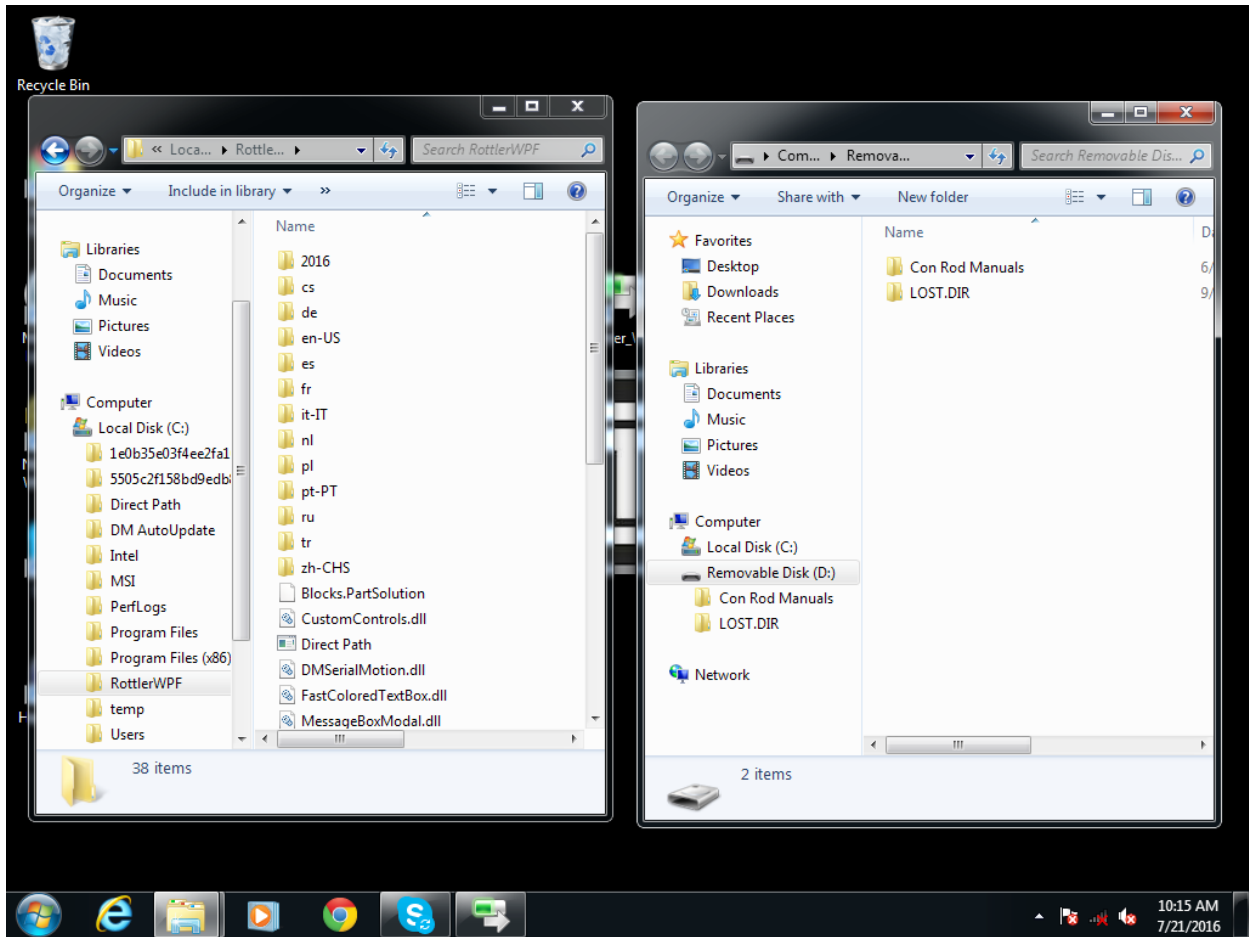

Block profiles are backed up each time the machine is run with the current profiles being shown in the RottlerWPF folder. All that needs to be done to back up the current profile is to simply drag it from the RottlerWPF folder to the flash drive folder. A copy of the file will be placed on the flash drive.

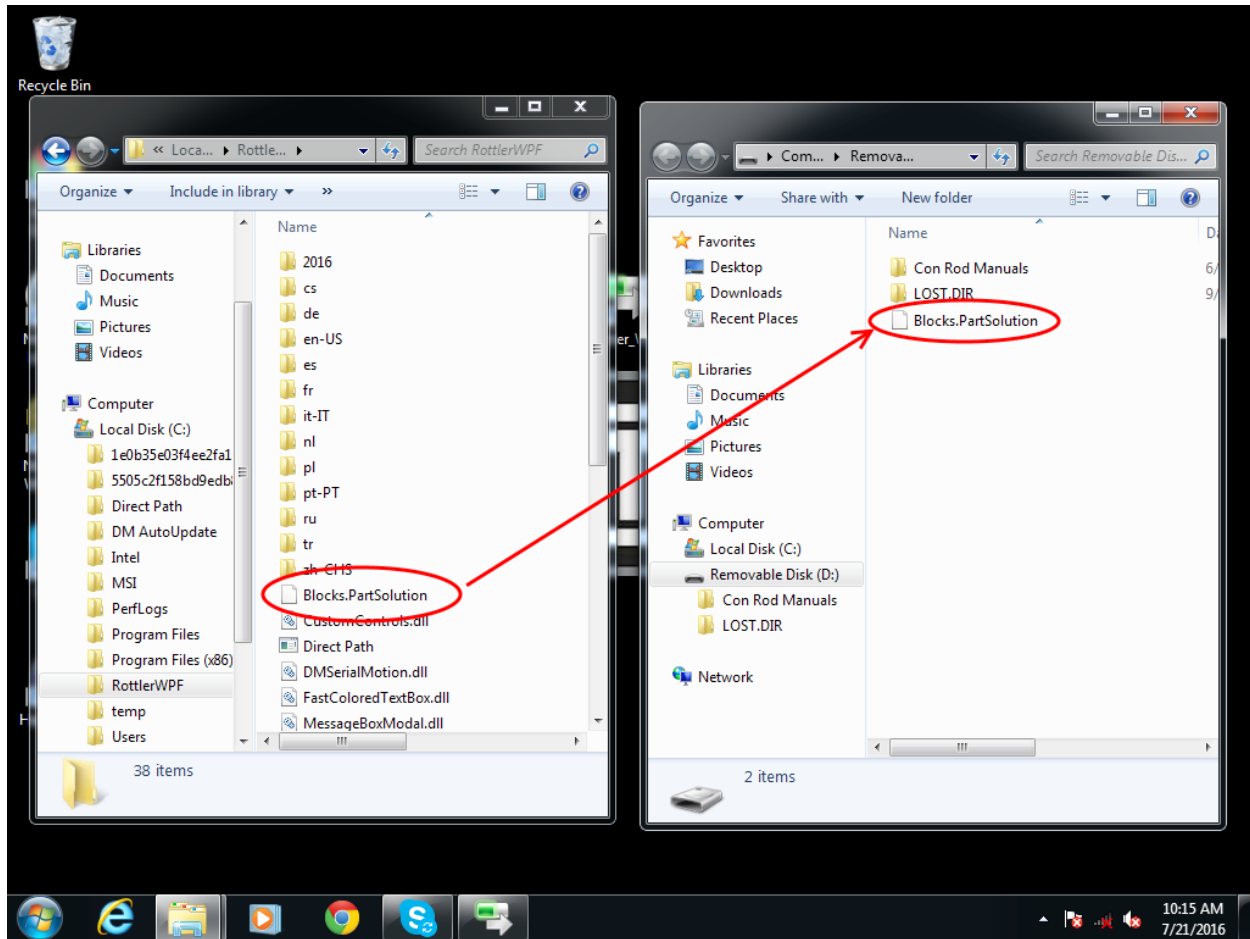

Backup is now complete. Close both file browser windows and remove the flash drive.

To restore or add block profiles go through the first 5 steps explained previously.

Highlight the block profiles file in the flash drive and drag it into the RottlerWPF folder on the local hard drive.

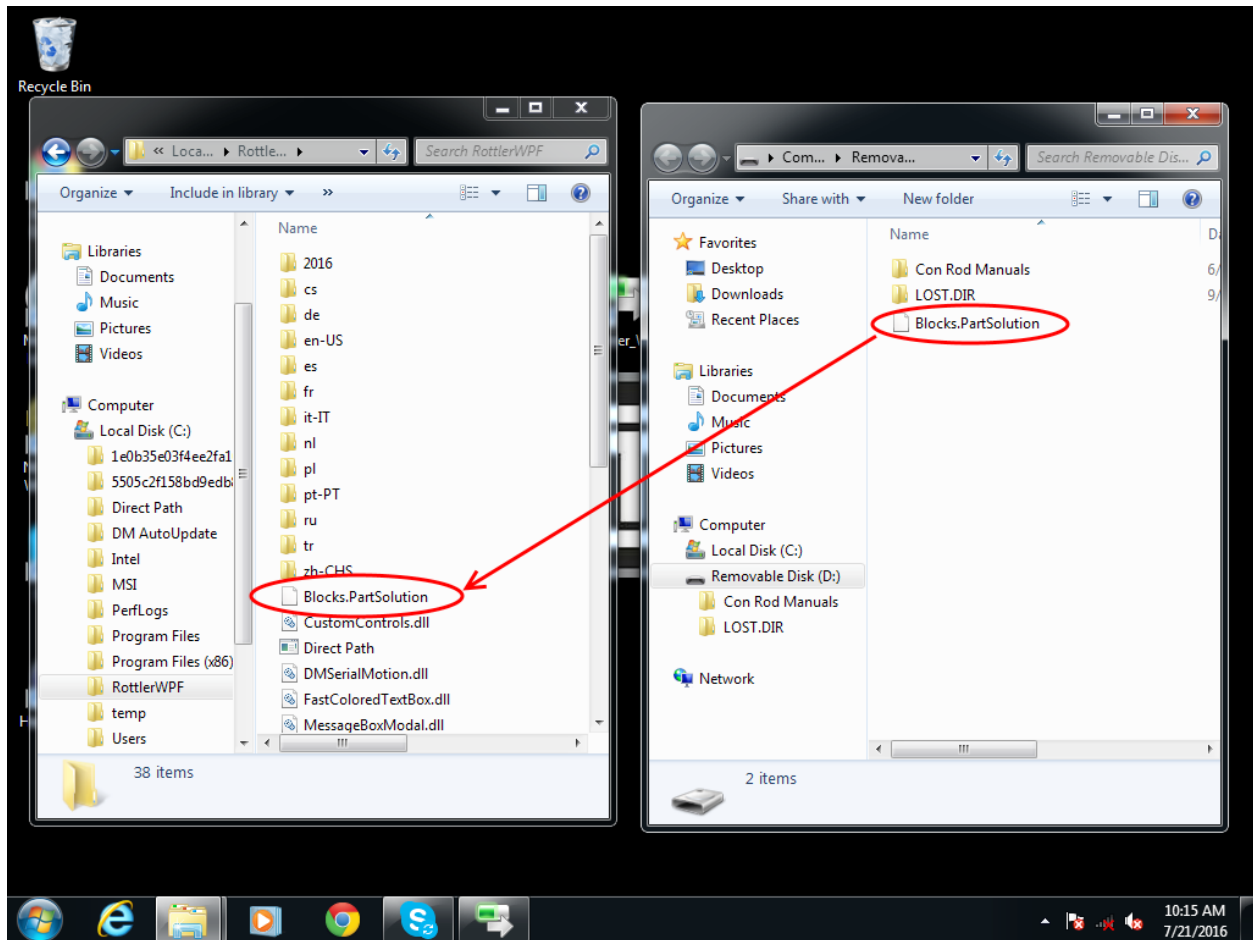

You will get a pop up window about there being a file of the same name in the destination folder. Click on the Copy and Replace option.

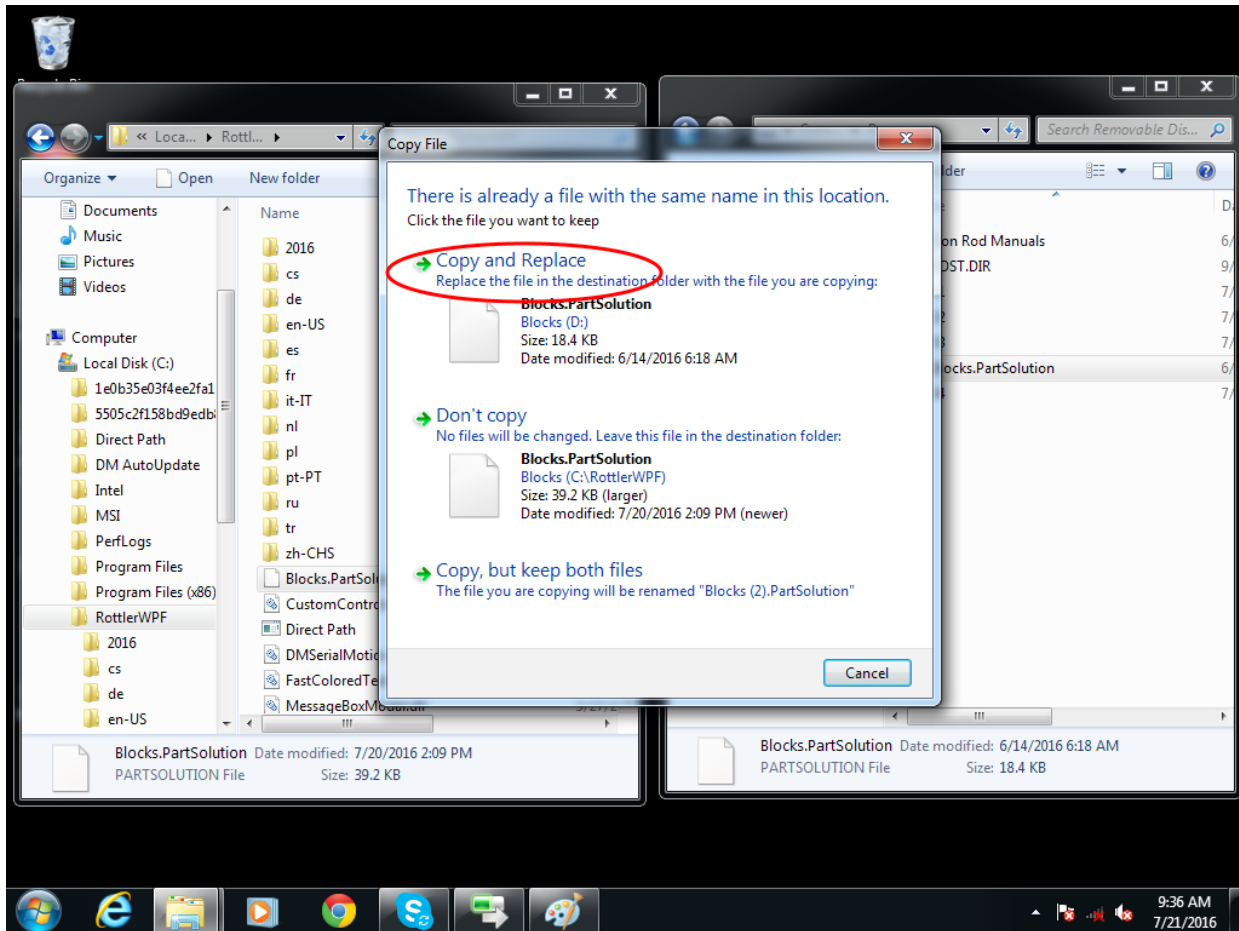

The archived block profiles will now be installed.

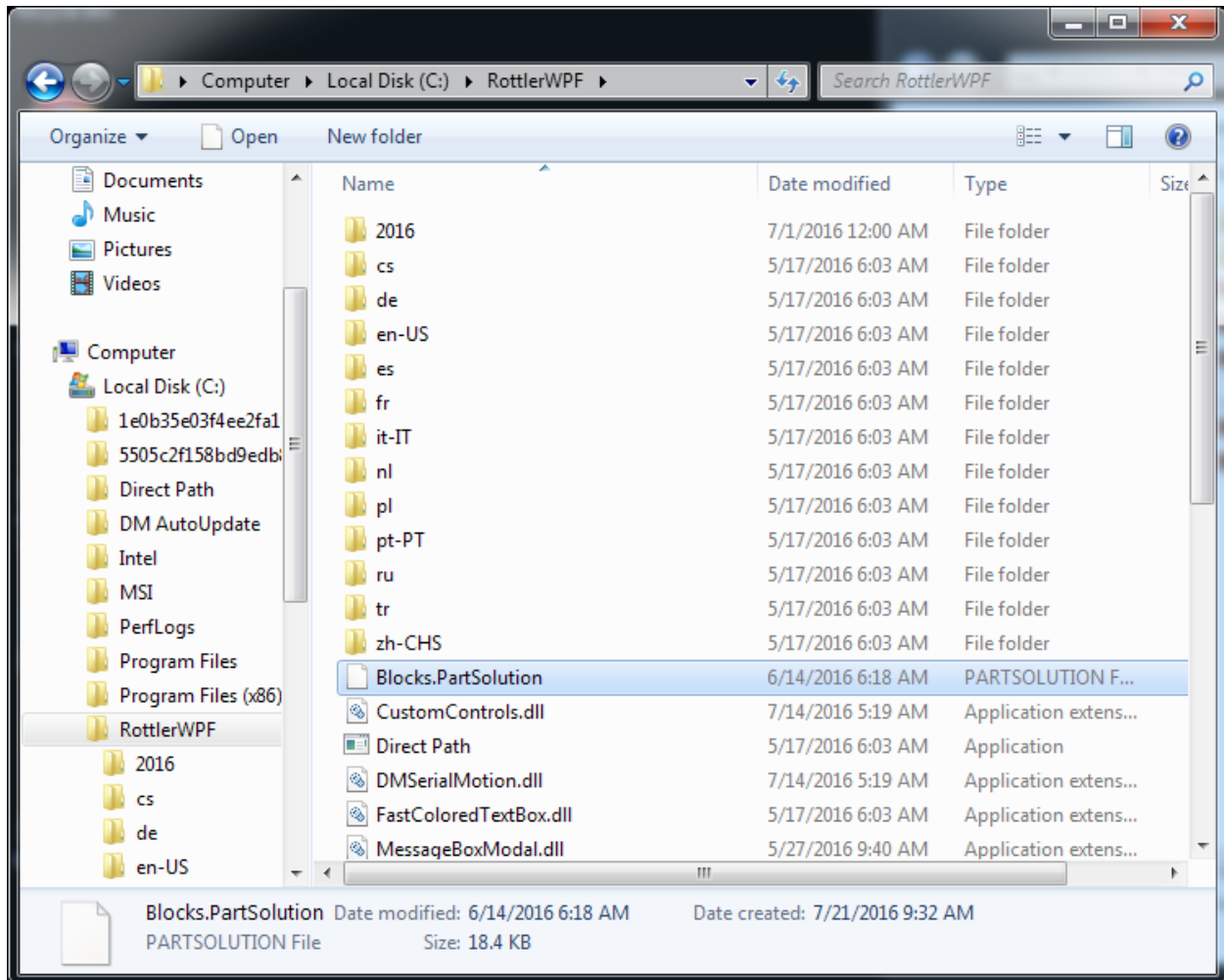

Close both browser windows and remove the flash drive. The restore process is now complete.

## Backing Up and Restoring RCam Programs

Click on the Windows icon and type “hidden” in the search box.

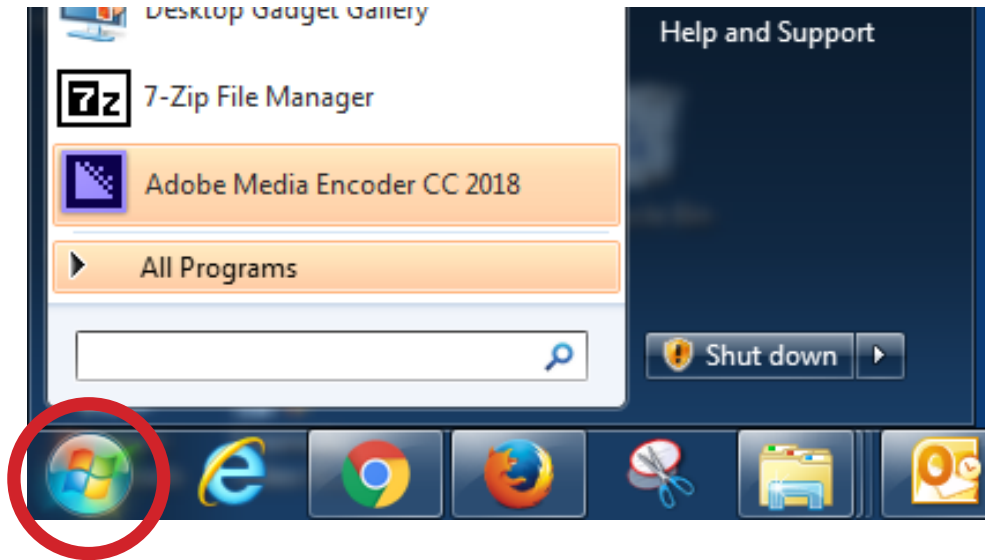

When the search results appear, click on the Show hidden files and folders option.

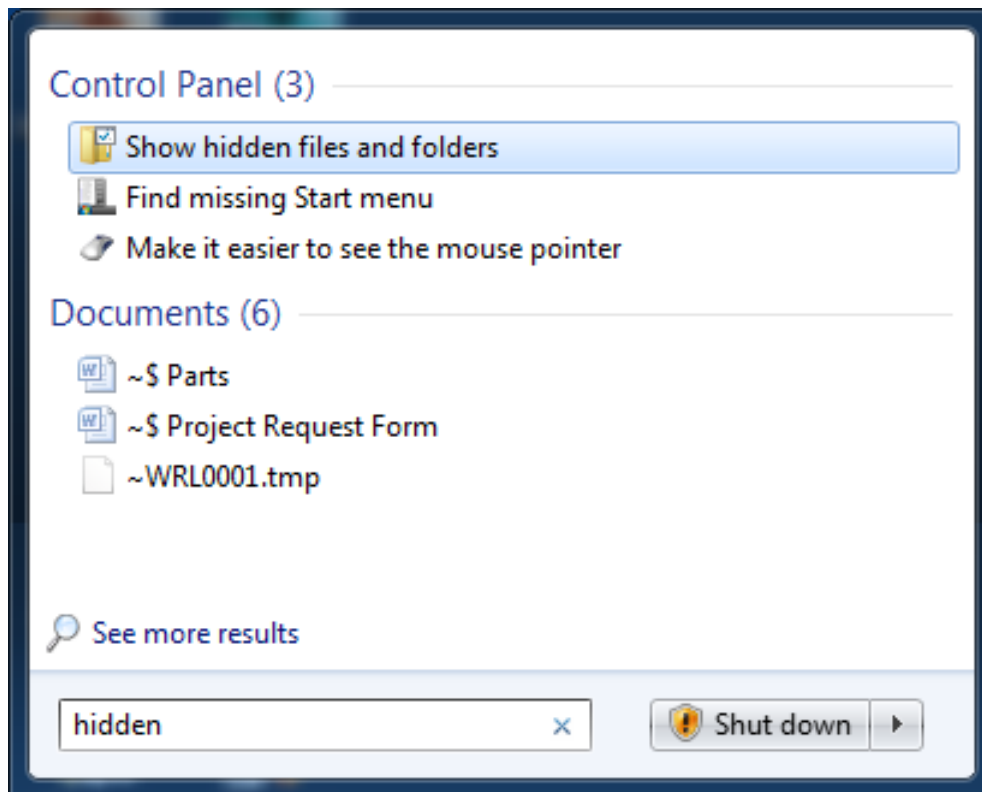

The Folders Options box will appear. Click to on the Show hidden files, folders, and drives to activate the option. Click on Apply, then OK.

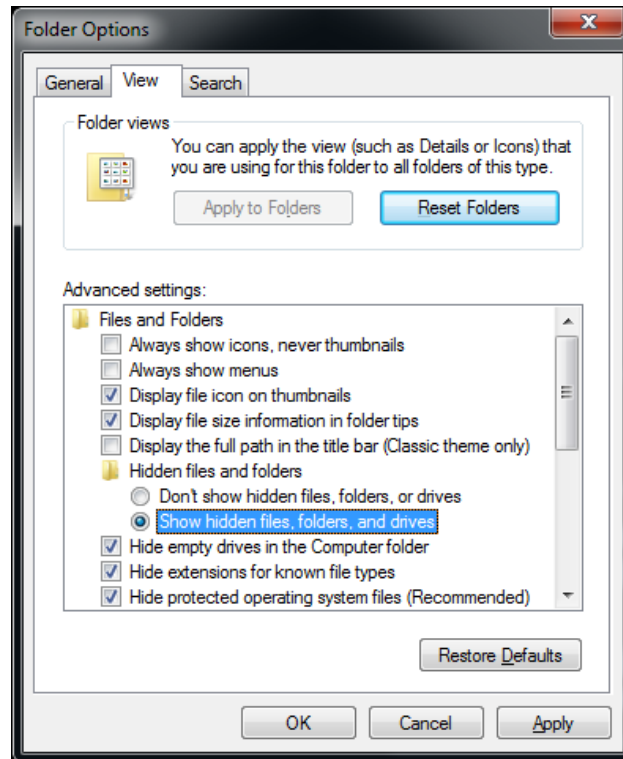

Right click on the desktop, click New, then click Folder. This will place and empty folder on the desktop. Give the folder a name. In this example the folder was named Erik Programs.

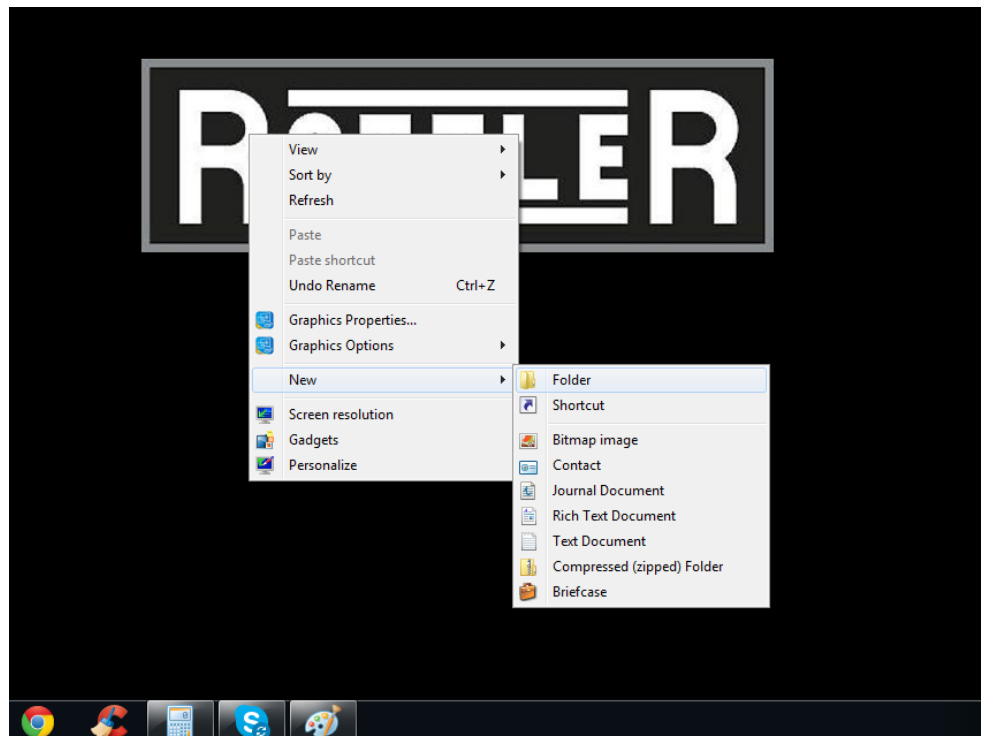

Open Windows Explorer and click on Local Disk (C), then Direct Path.

Once the Direct Path folder is open, locate all the PartSolution files and move them into the folder you created.

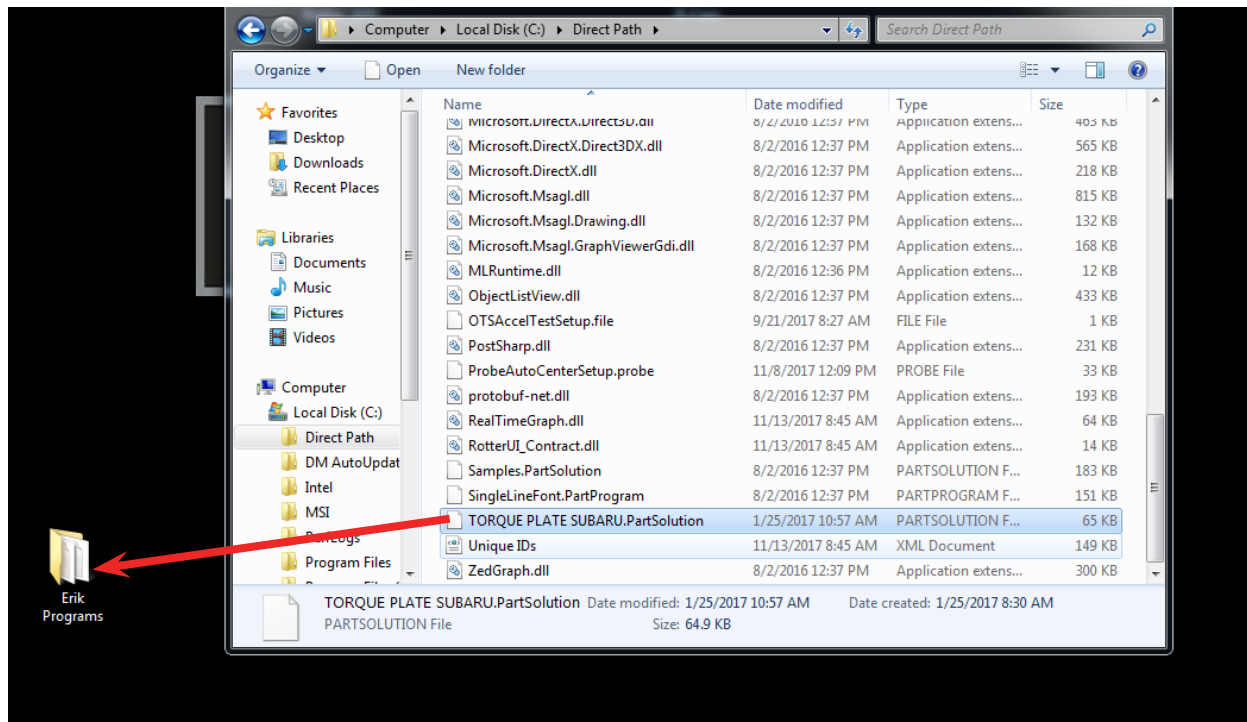

Once you have completed moving all the files, open the folder to confirm that the files are in the folder.

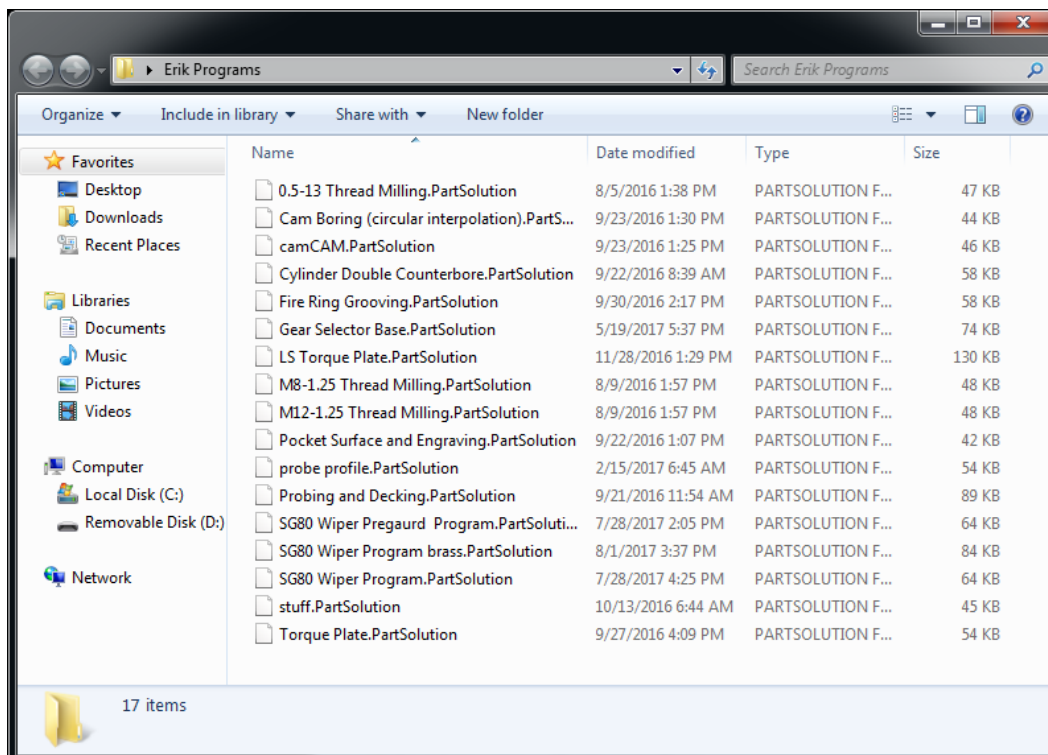



Take a flash drive and plug it into an open usb port located on the side of the monitor housing.

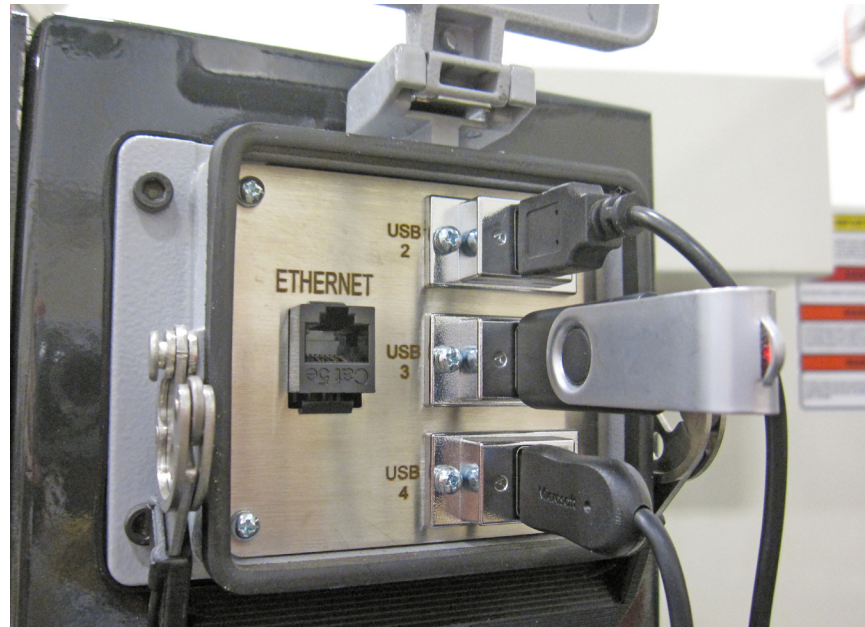

When the AutoPlay window appears, click on Open folder to view files.

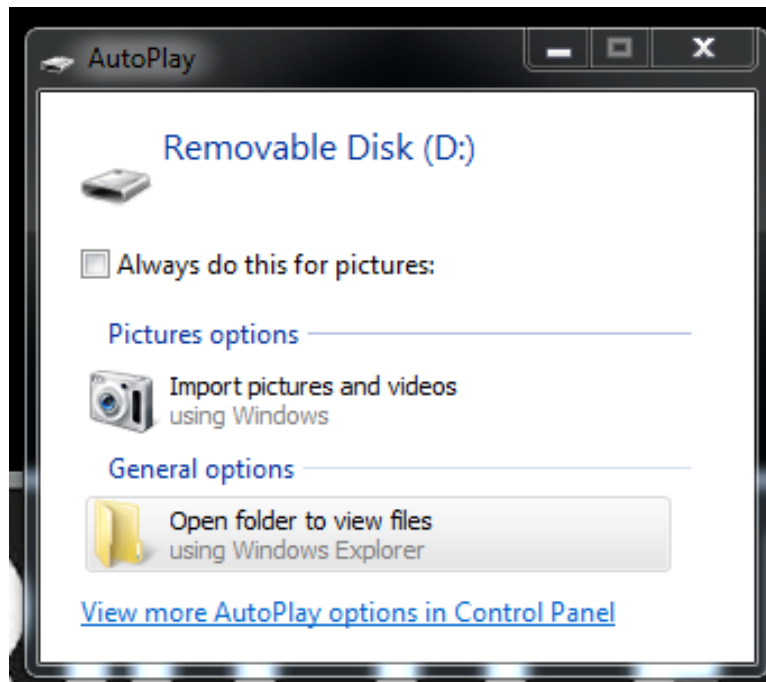

Once the window for the flash drive opens, click and drag the folder you created into the flash drive folder.

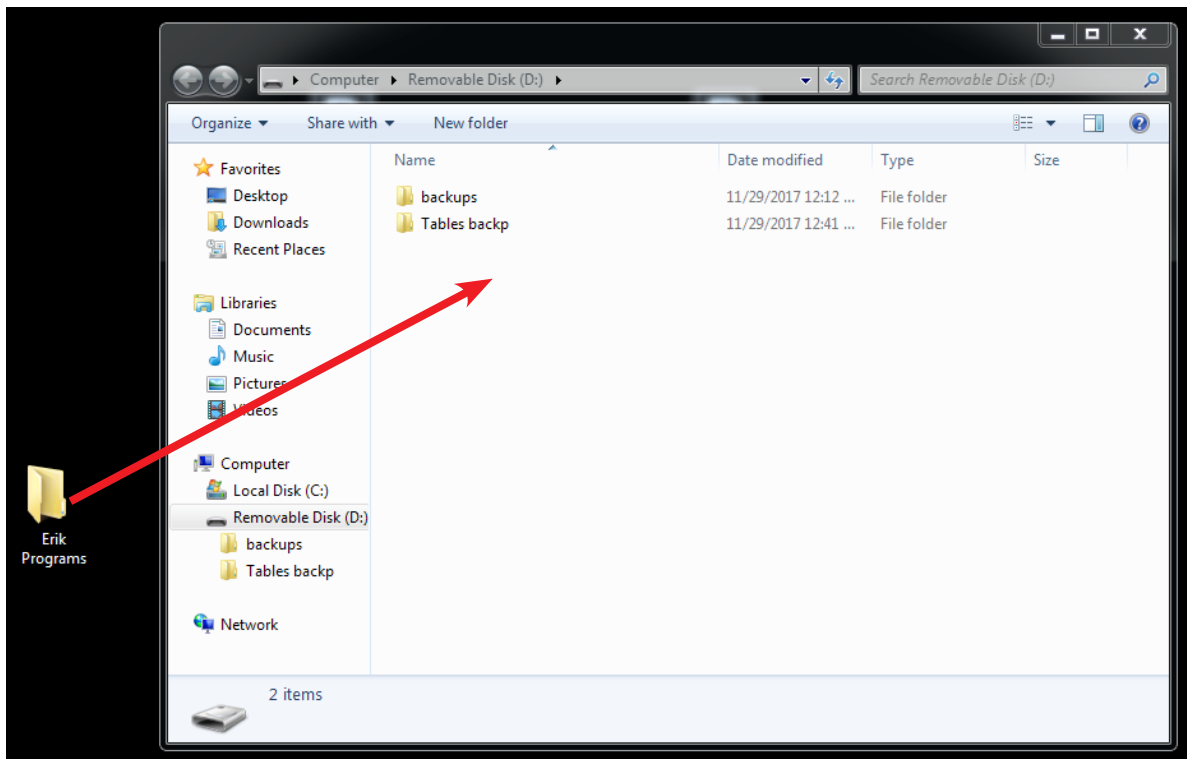

A copy of the folder will appear in the flash drive directory. Backup is now complete. Close the window and remove the flash drive.

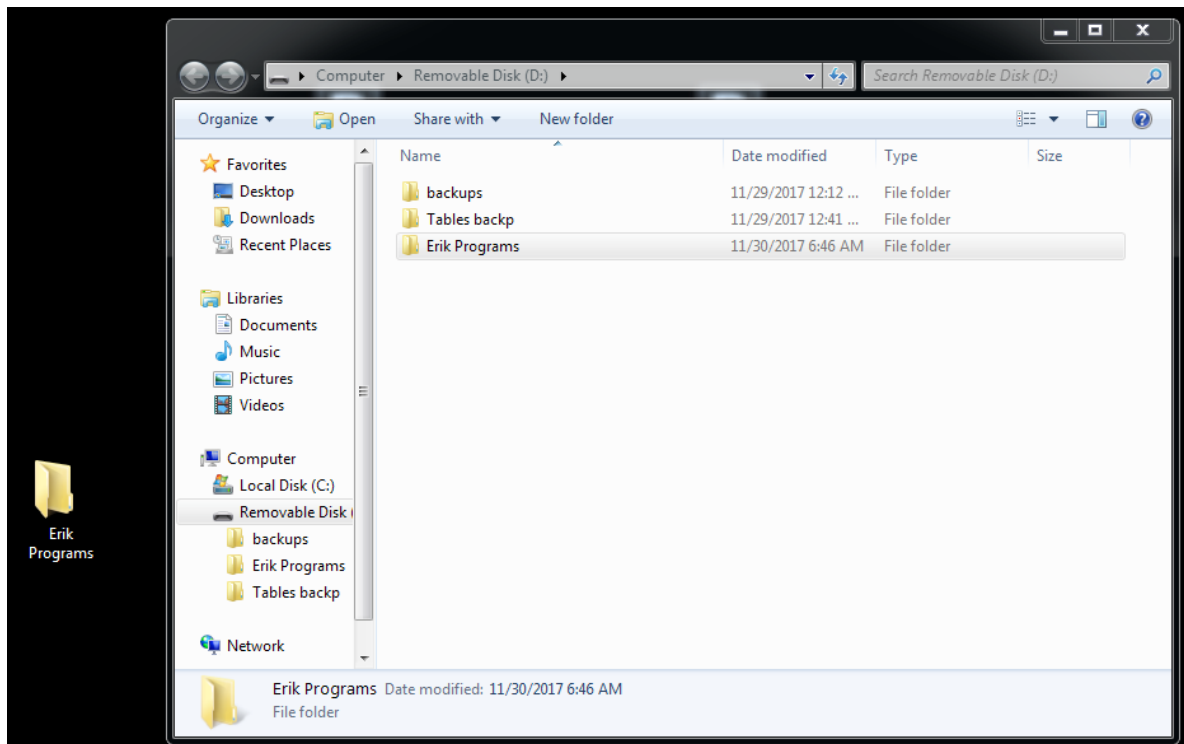

To restore RCam programs plug the flash drive with the backups into the usb hub on the side of the monitor housing.

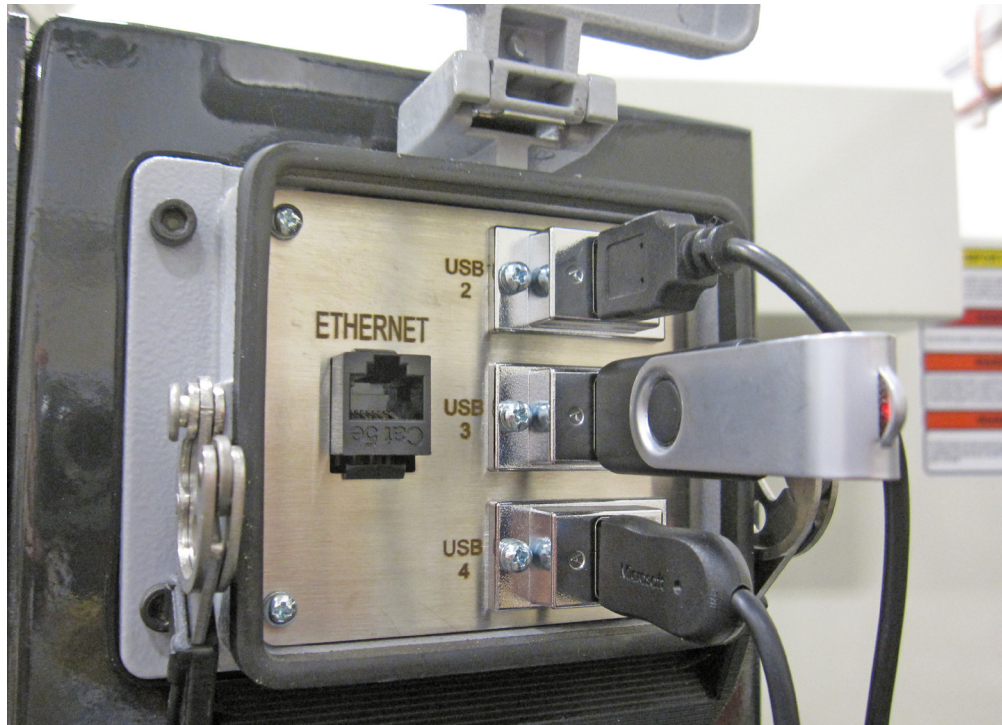

When the AutoPlay window appears, click on Open folder to view files.

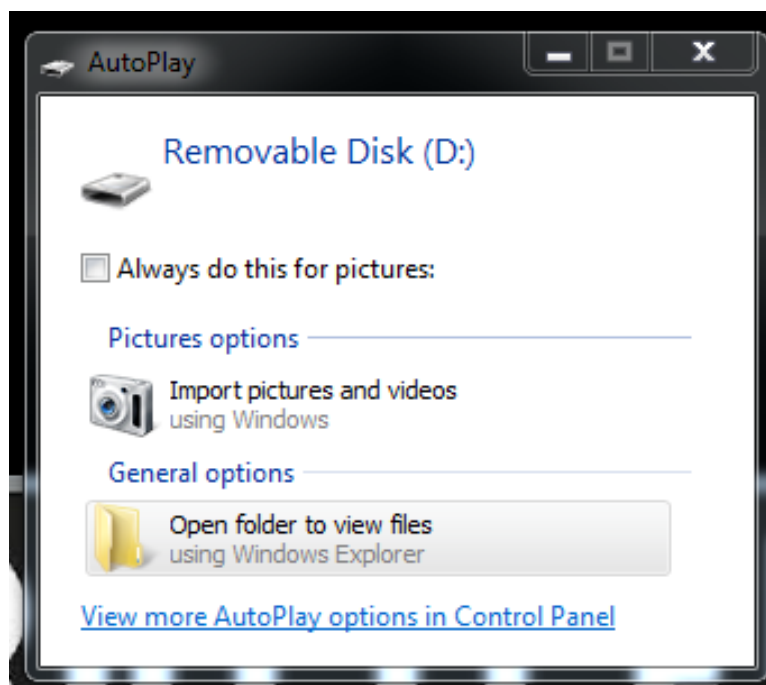

Once the window for the flash drive opens, click and drag the backup folder to the desktop.

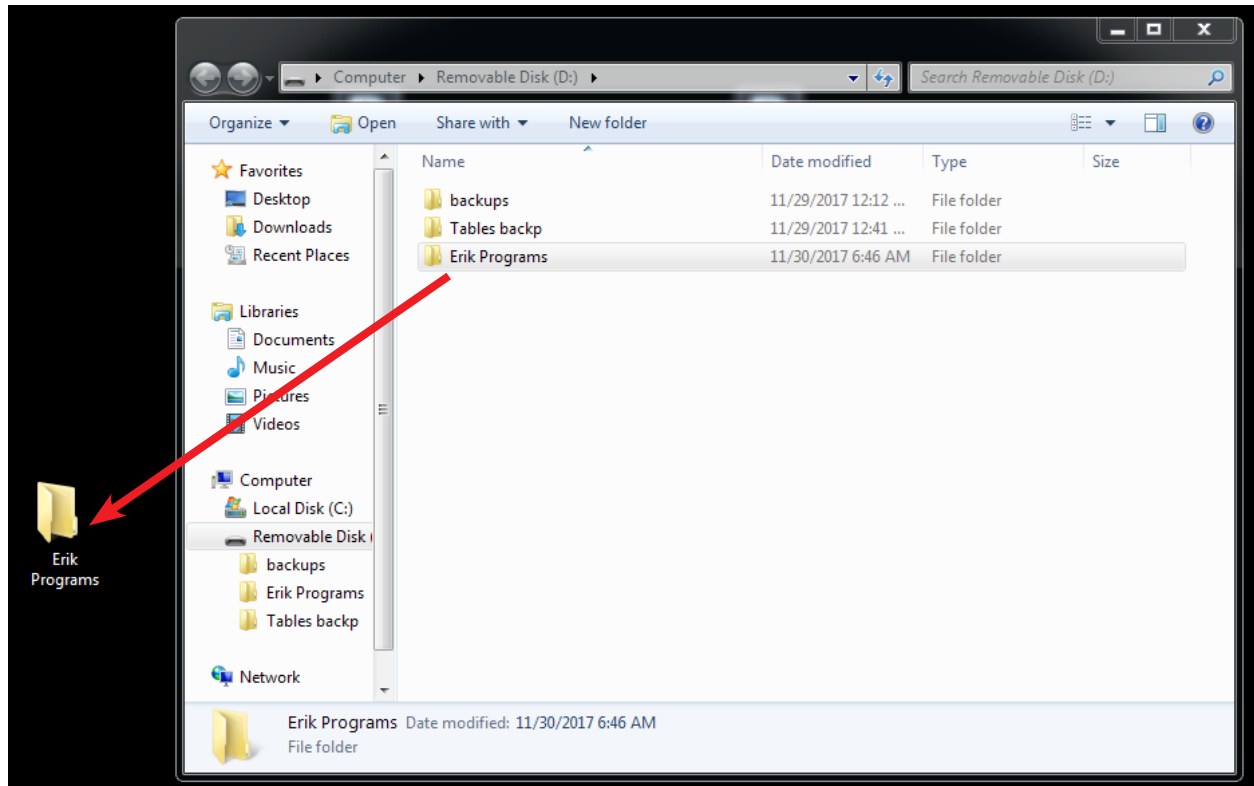

If you still have a program folder on the desktop you will get the following message. Click Yes.

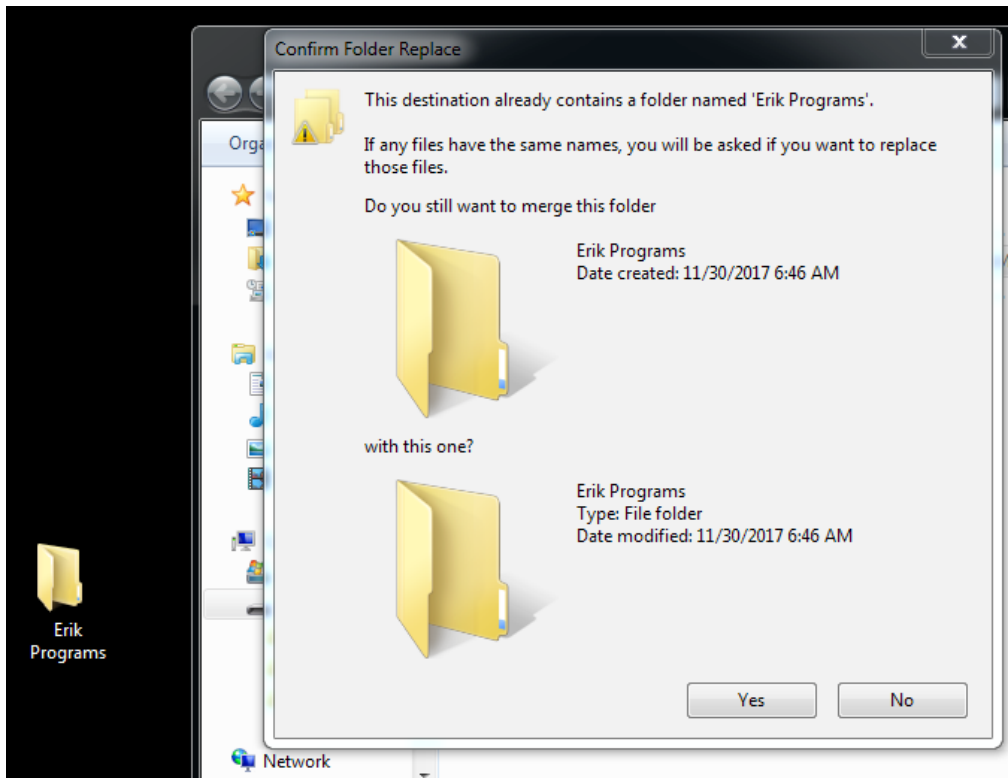

If the Copy File window appears, click on the Copy and Replace option.

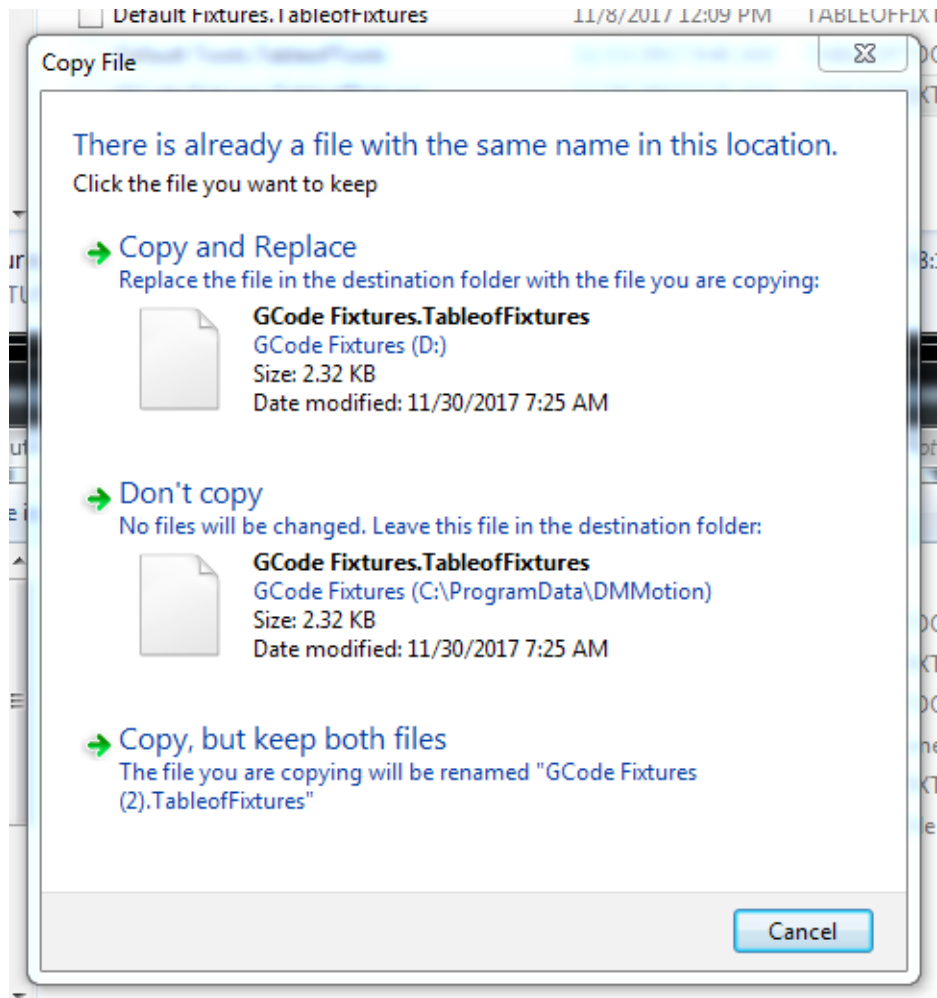

After all the programs have been restored close the window and remove the flash drive.

## Backing Up and Restoring RCam Tables

Click on the Windows icon and type “hidden” in the search box.

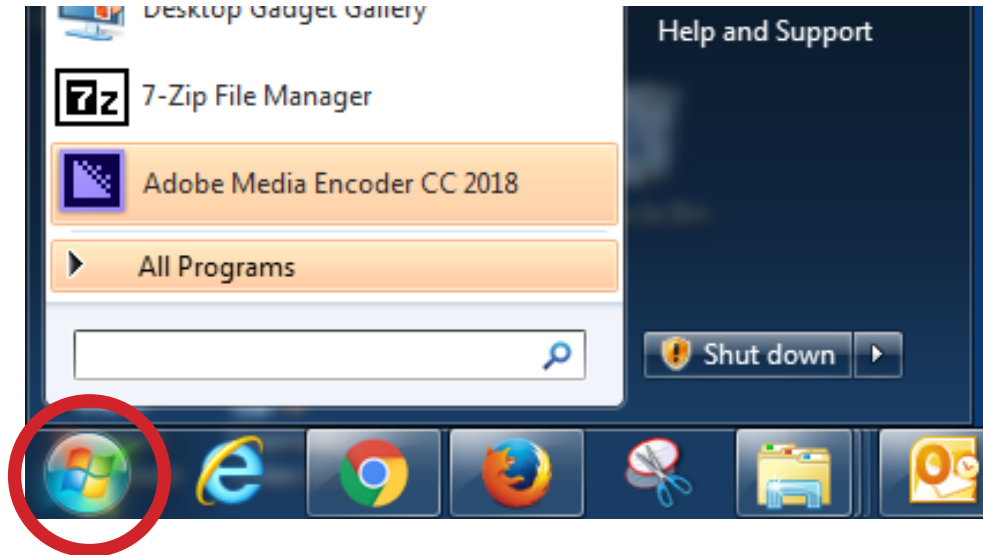

When the search results appear, click on the Show hidden files and folders option.

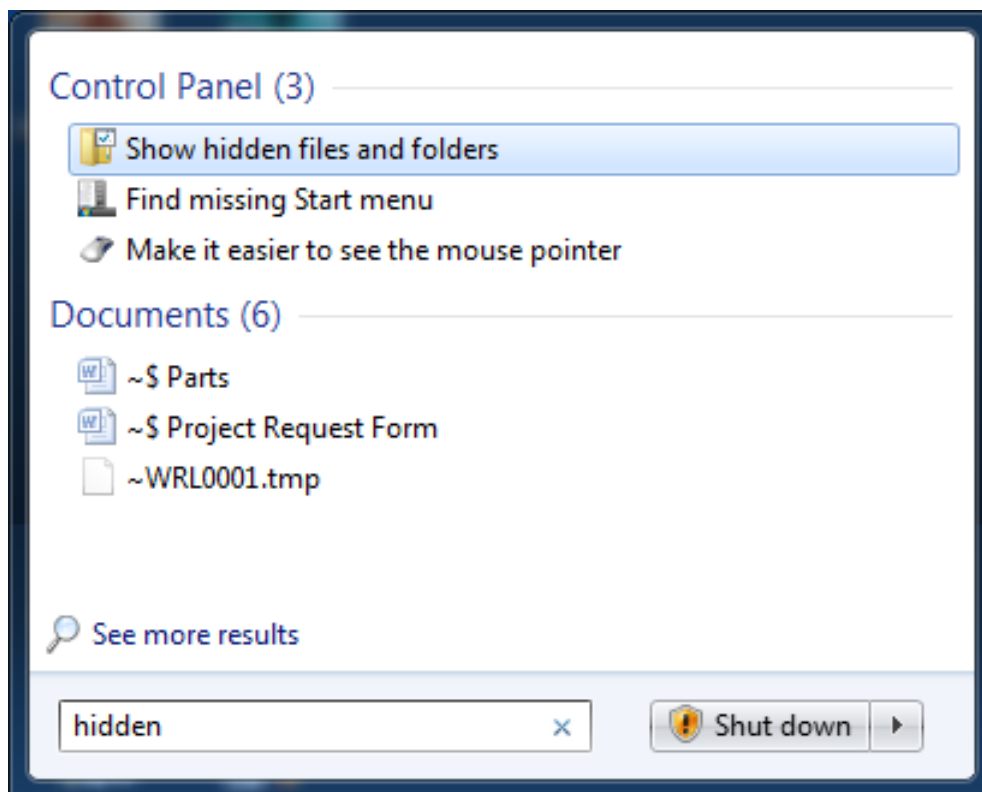



The Folders Options box will appear. Click to on the Show hidden files, folders, and drives to activate the option. Click on Apply, then OK.

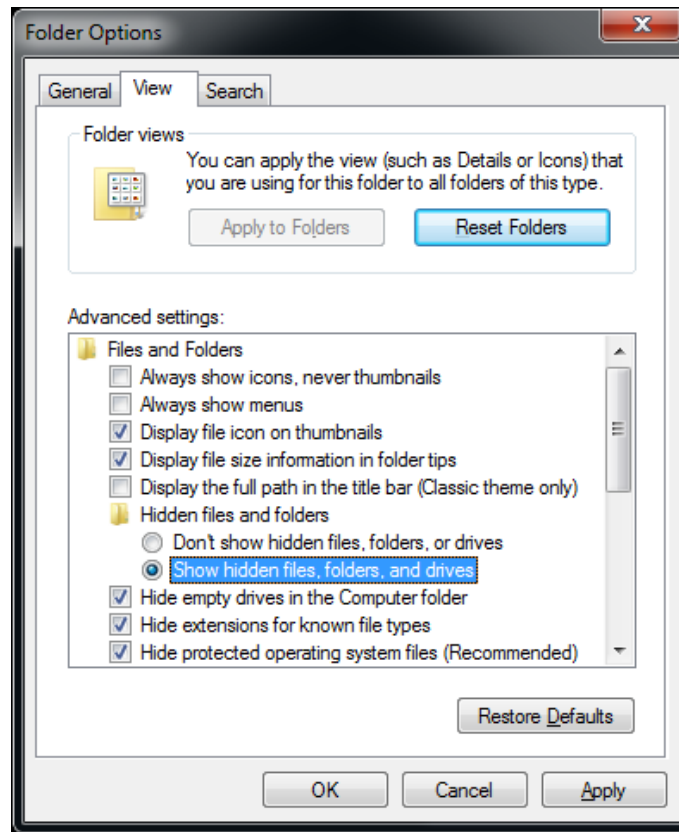

Take a flash drive and plug it into an open usb port located on the side of the monitor housing.

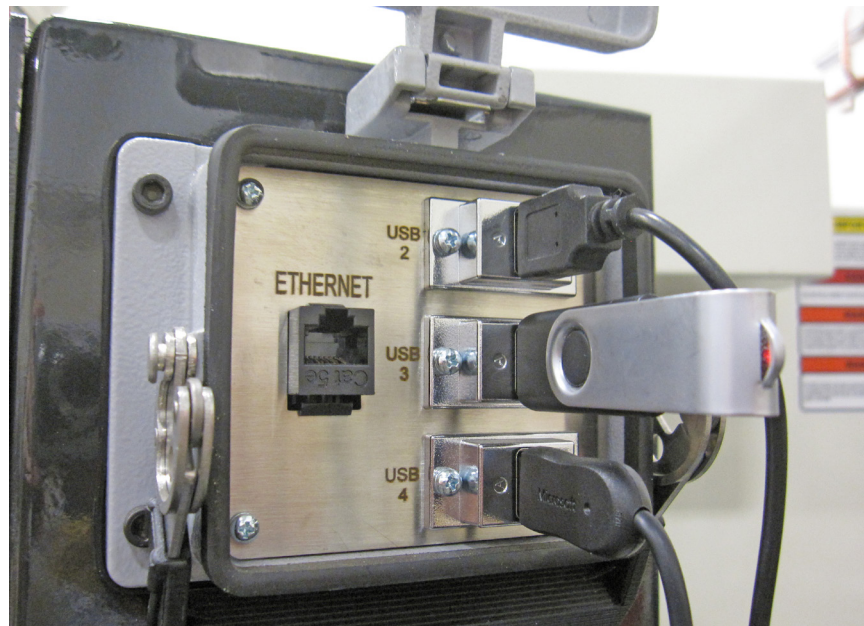

When the AutoPlay window appears, click on Open folder to view files.

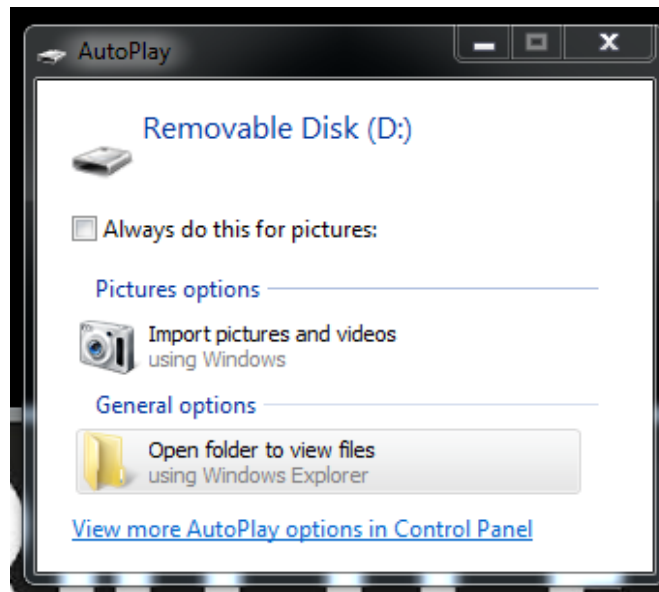

When the explorer window opens, click on Local Disk (C:), then ProgramData folder to open it.

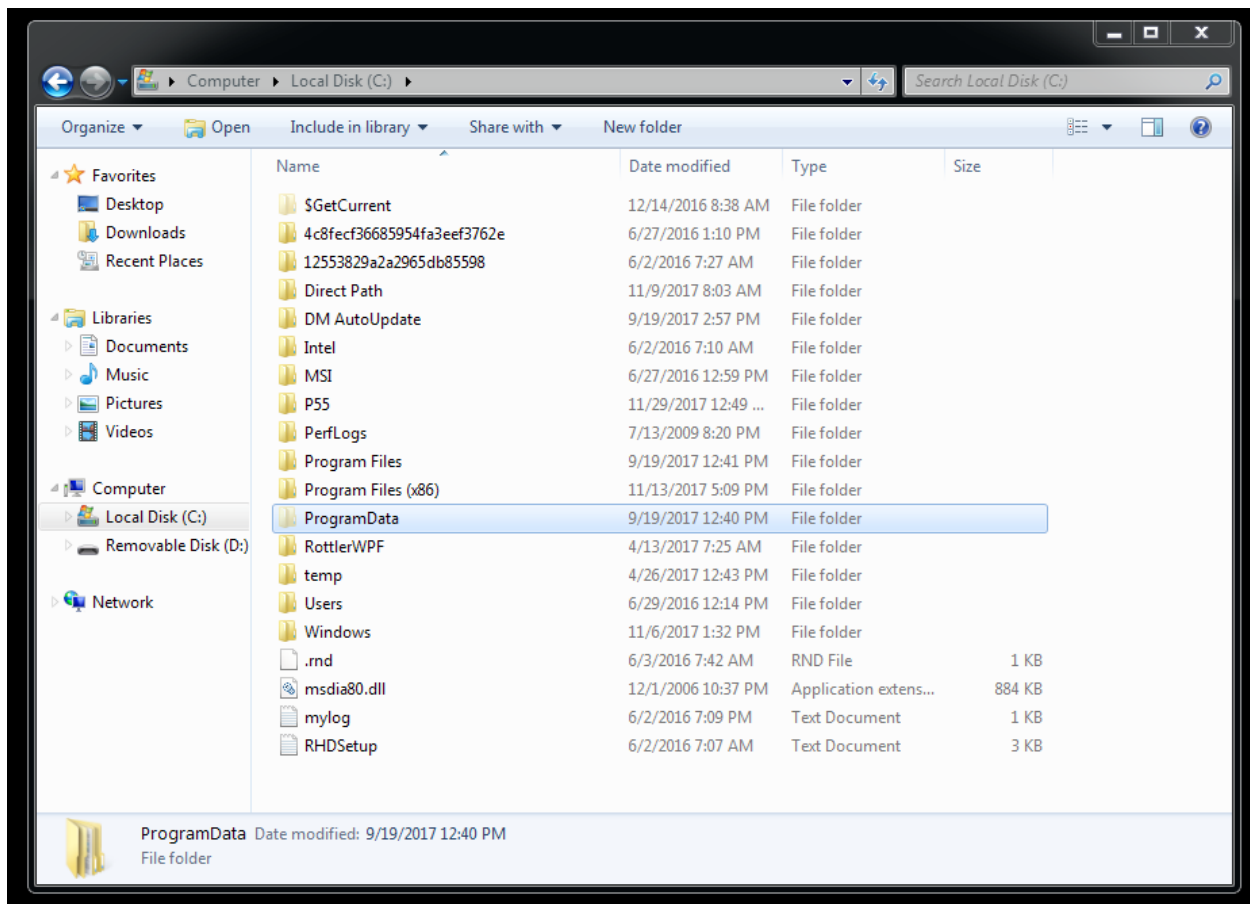



Click on the DMMotion folder to open it.

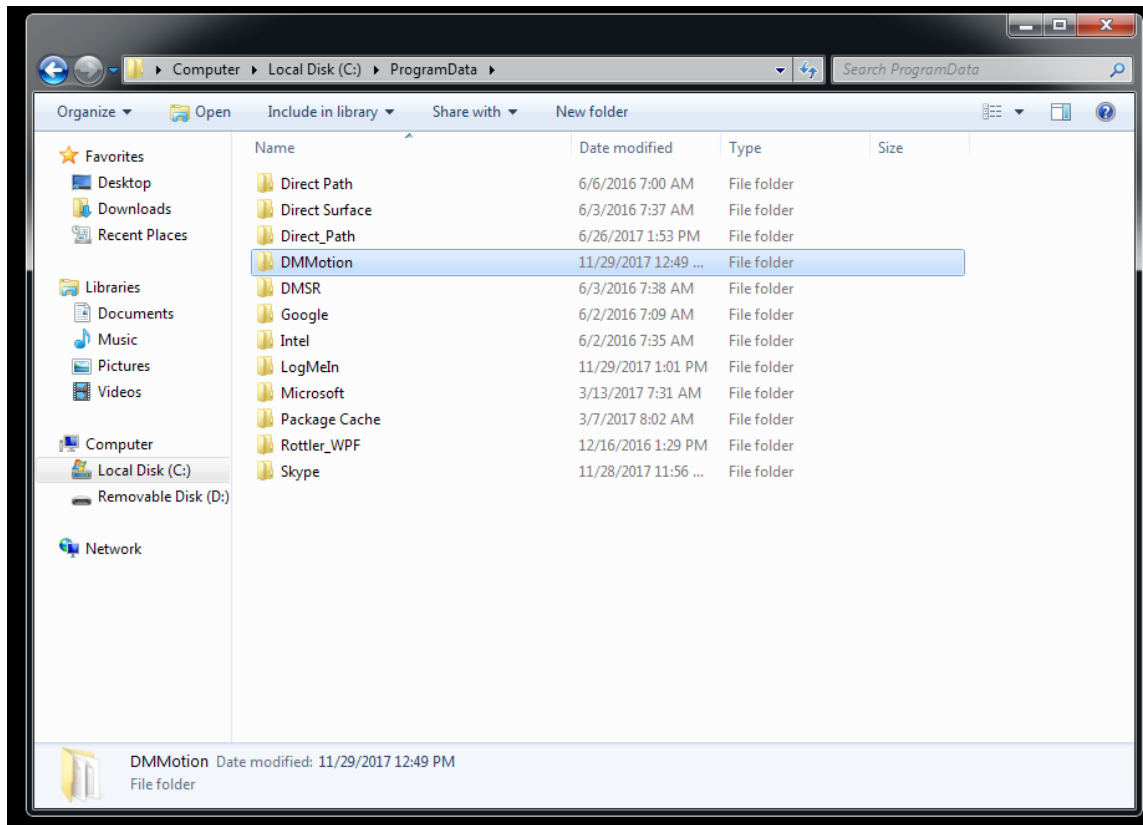

Once the folder is open find all the Table files and drag them to the flash drive.

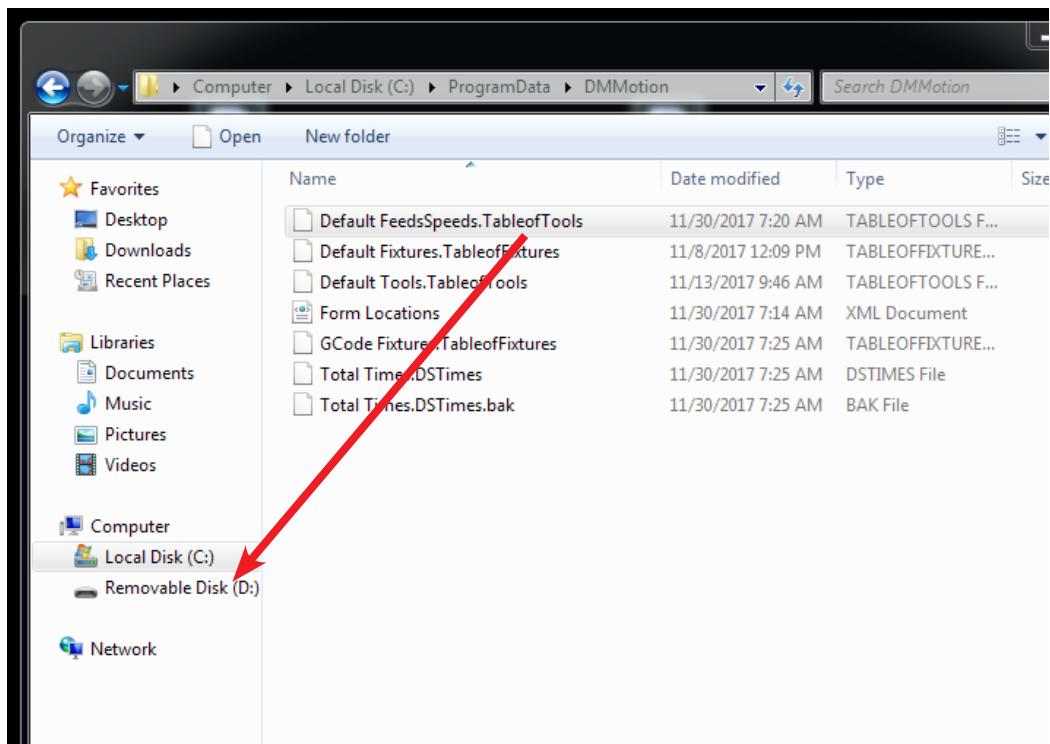

Open the flash drive folder to confirm that all the Tables files were copied.

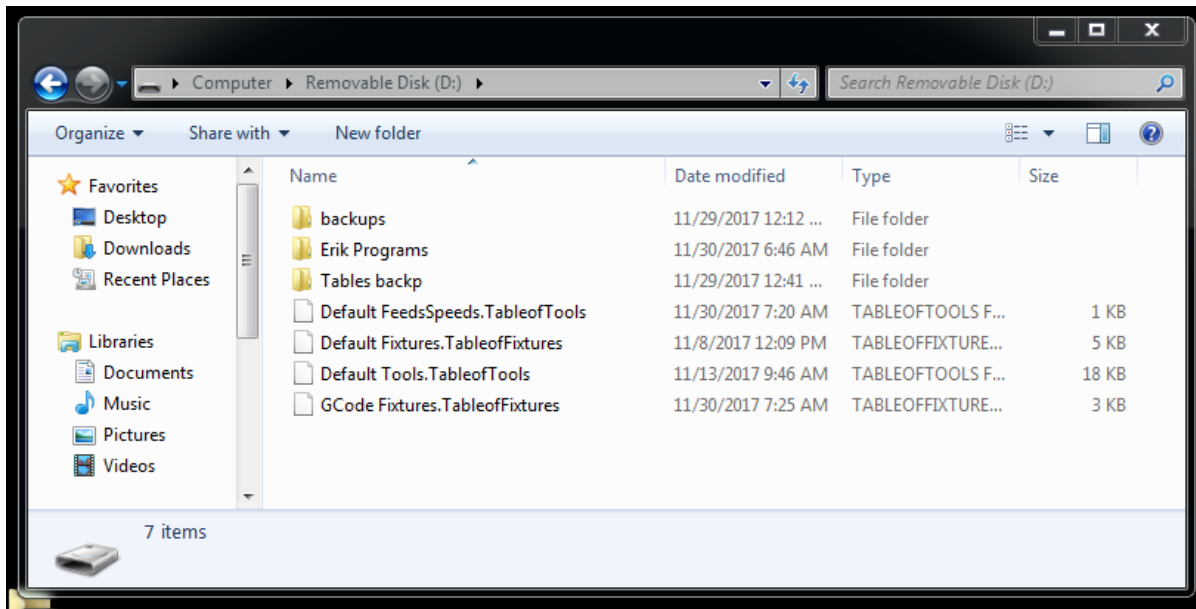

Close the window and remove the flash drive. Backup is now completed.

To restore RCam programs plug the flash drive with the backups into the usb hub on the side of the monitor housing.

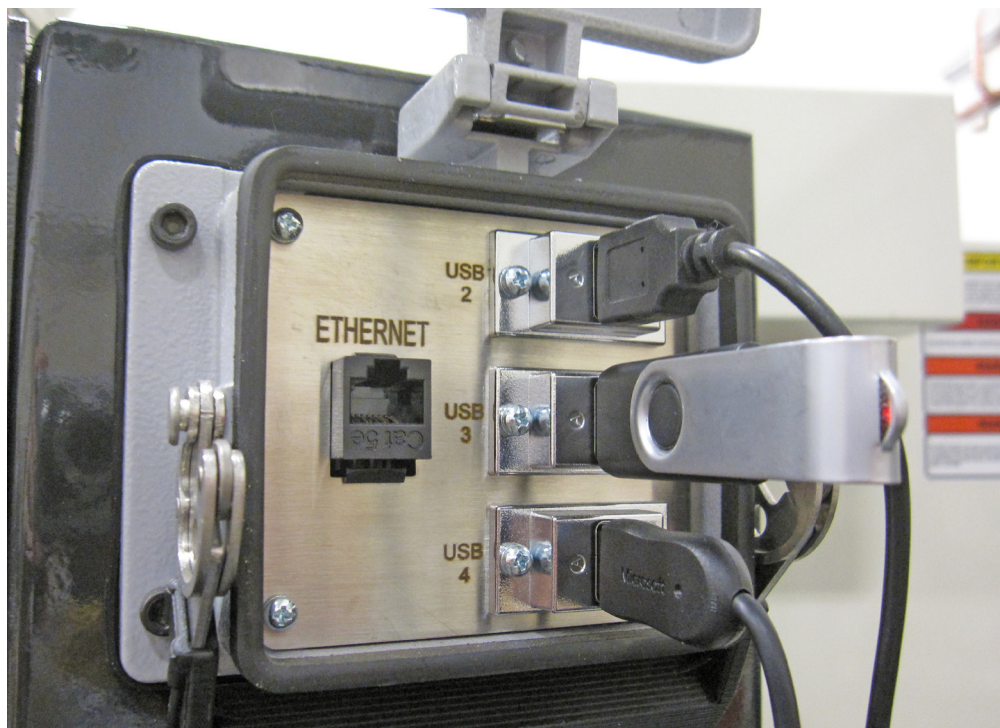

When the AutoPlay window appears, click on Open folder to view files.

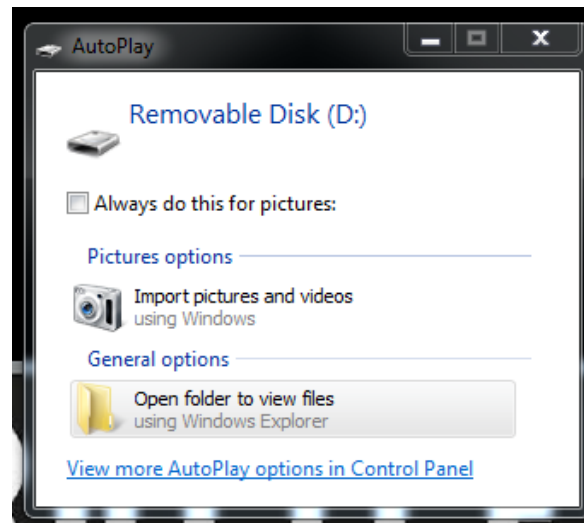

Open a second file explorer window and navigate to the DMMotion folder. Arrange both windows as shown.

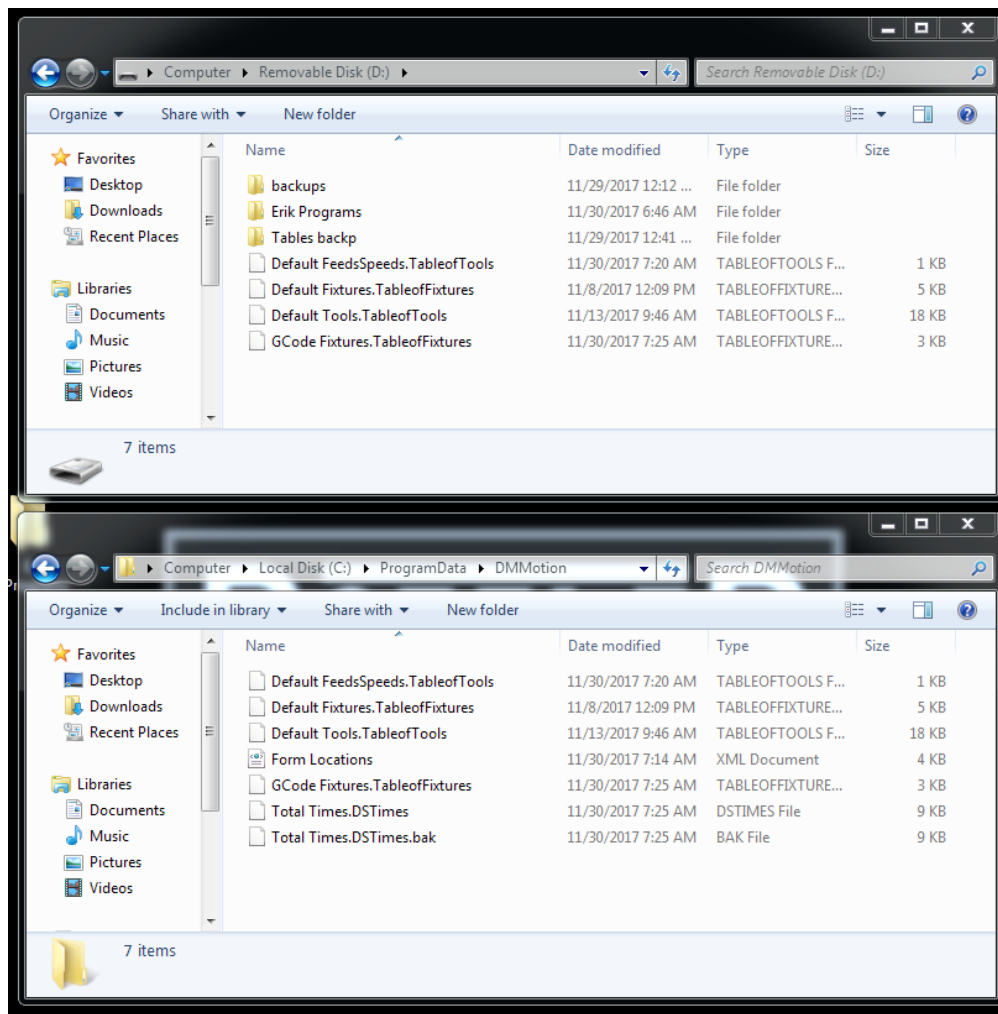

Drag all the Table files from the flash drive to the DMMotion folder.

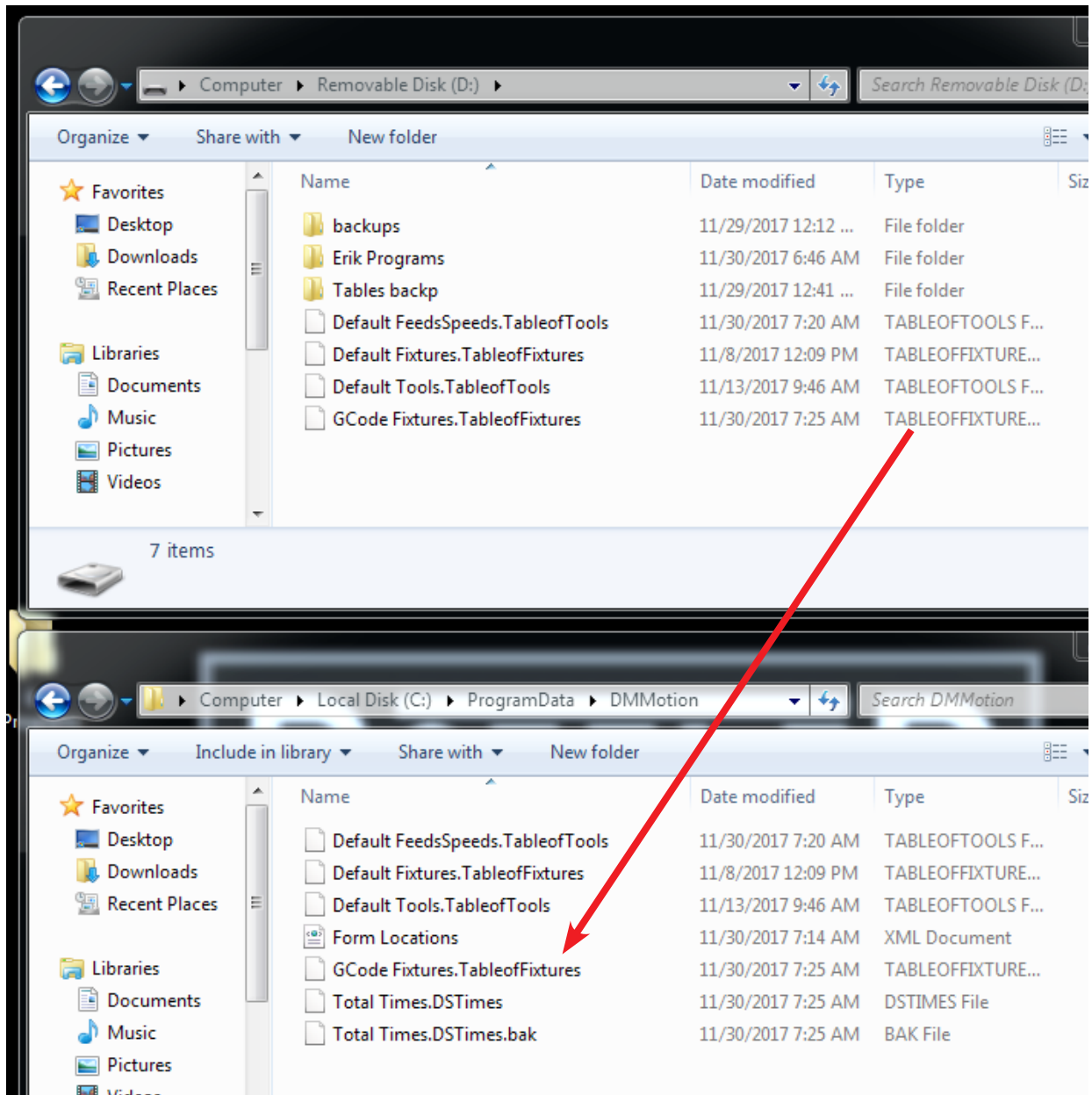

If the Copy File window appears, click on the Copy and Replace option.

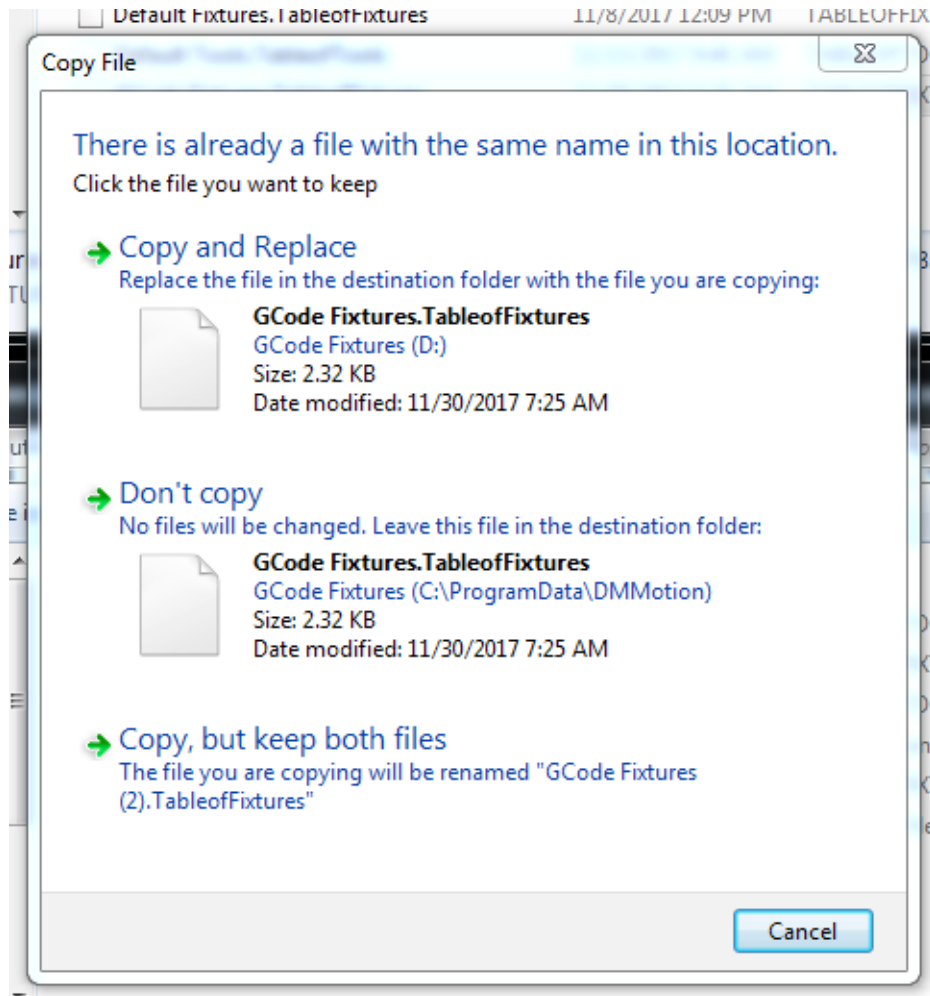

After all the programs have been restored close the window and remove the flash drive.

## Backing Up and Restoring Porting Programs

Click on the Windows icon and type “hidden” in the search box.

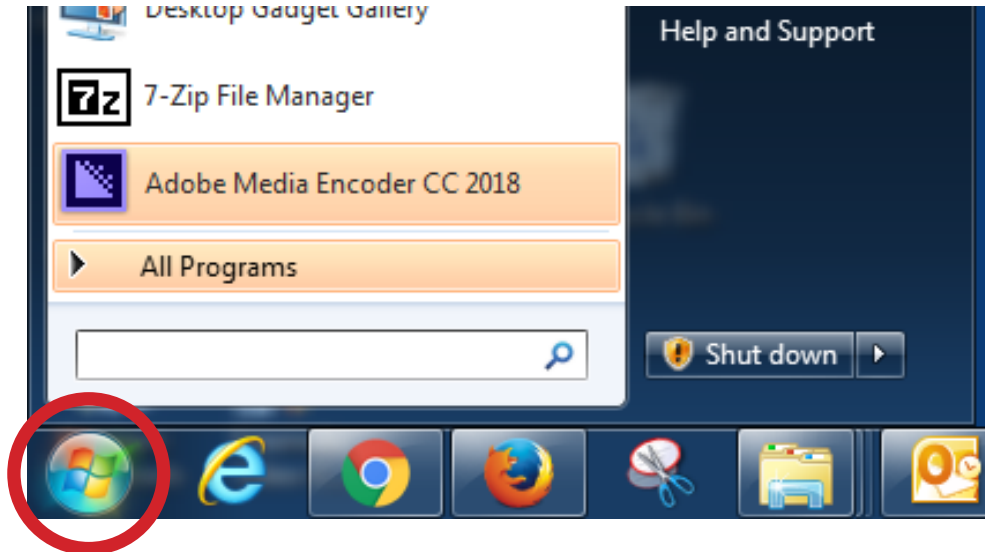

When the search results appear, click on the Show hidden files and folders option.

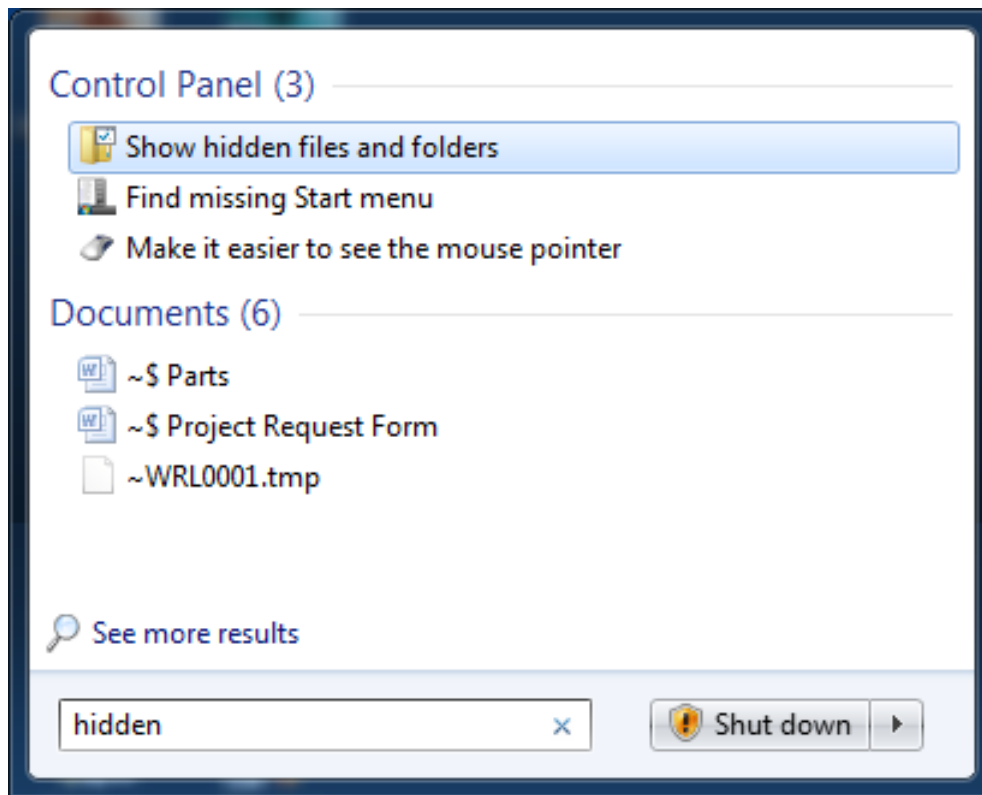

The Folders Options box will appear. Click on the Show hidden files, folders, and drives to activate the option. Click on Apply, then OK.

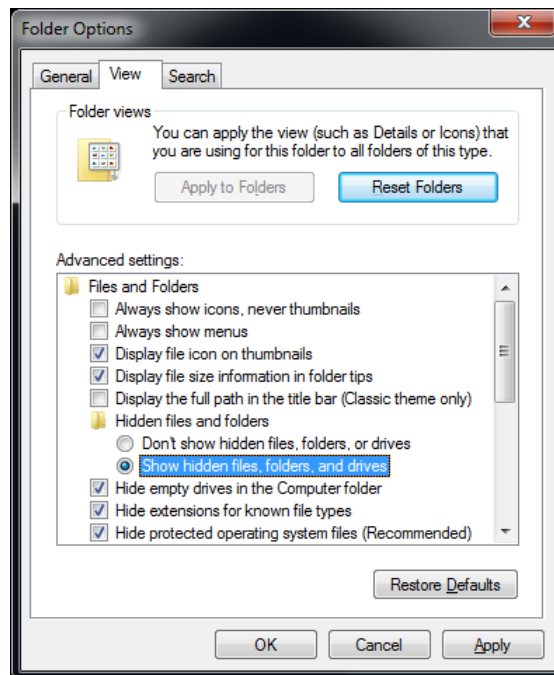

If it hasn't already been done create individual file folders in the My Documents folder for each porting program and move the program files associated with that program into an named folder. Program files are located in the P55 folder of the Local Disk (C) folder.

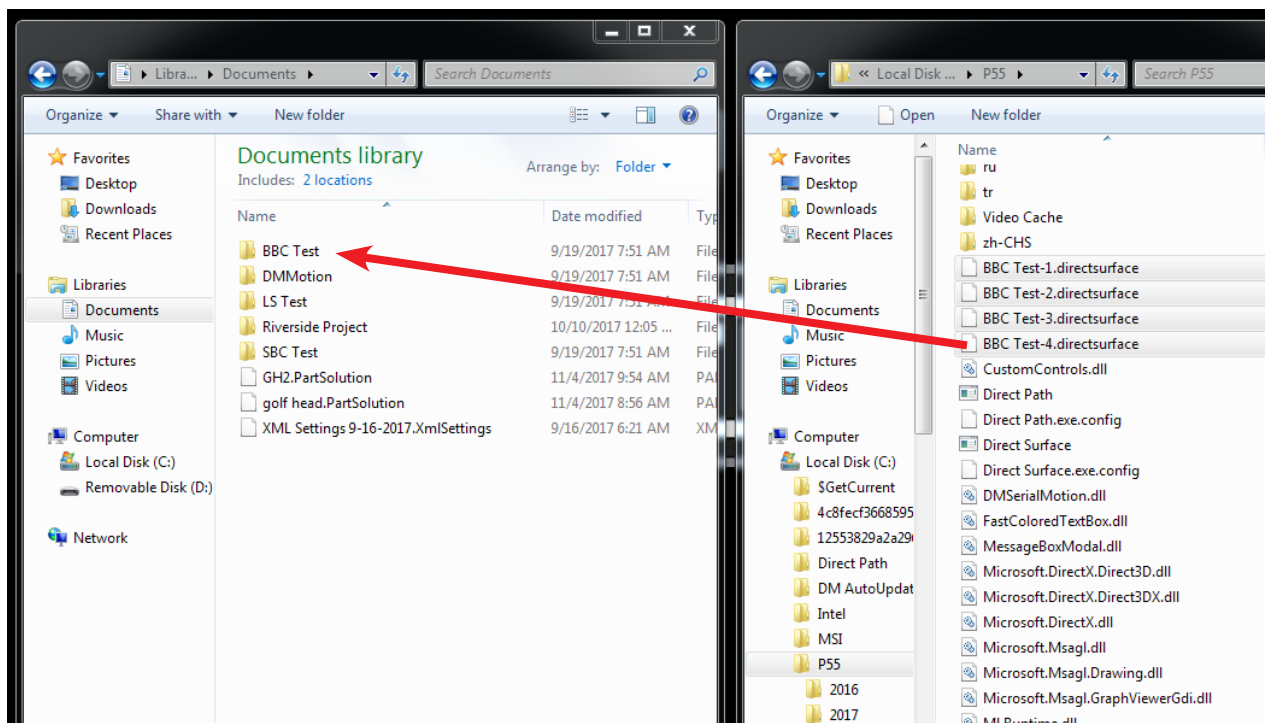



Insert a flash drive into an open port on the usb hub located on the monitor housing.

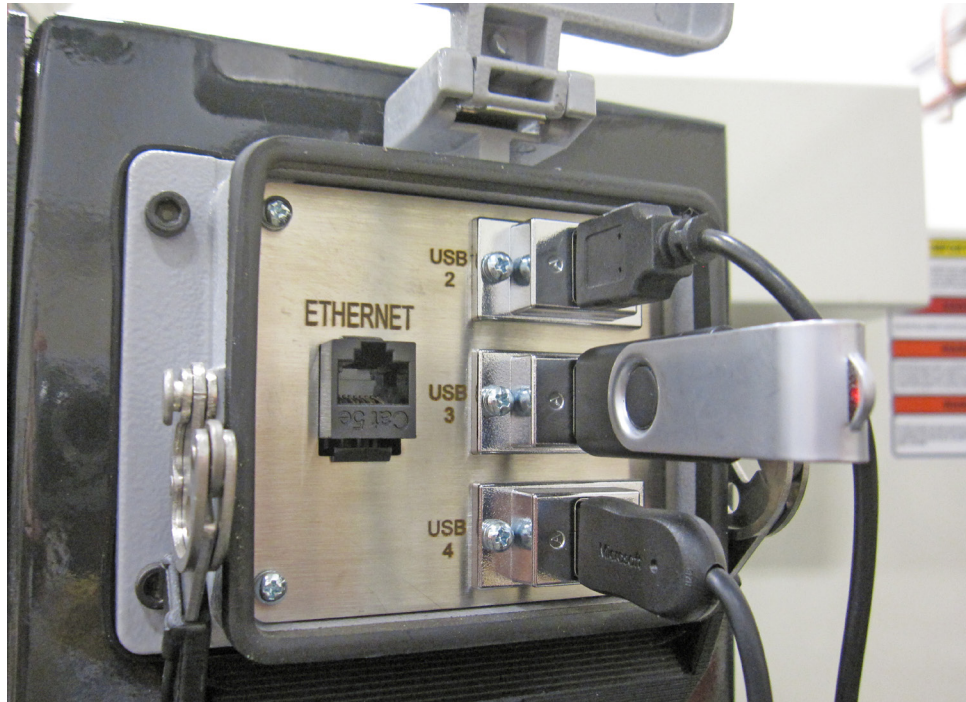

When the AutoPlay window appears, click the X to close the window.

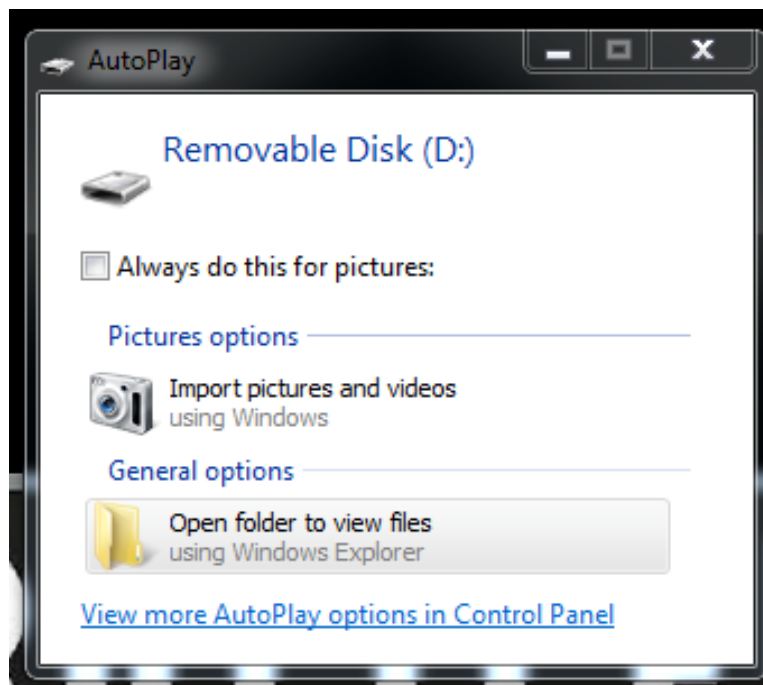



Open the Documents folder. Drag the folders containing porting programs to the flash drive.

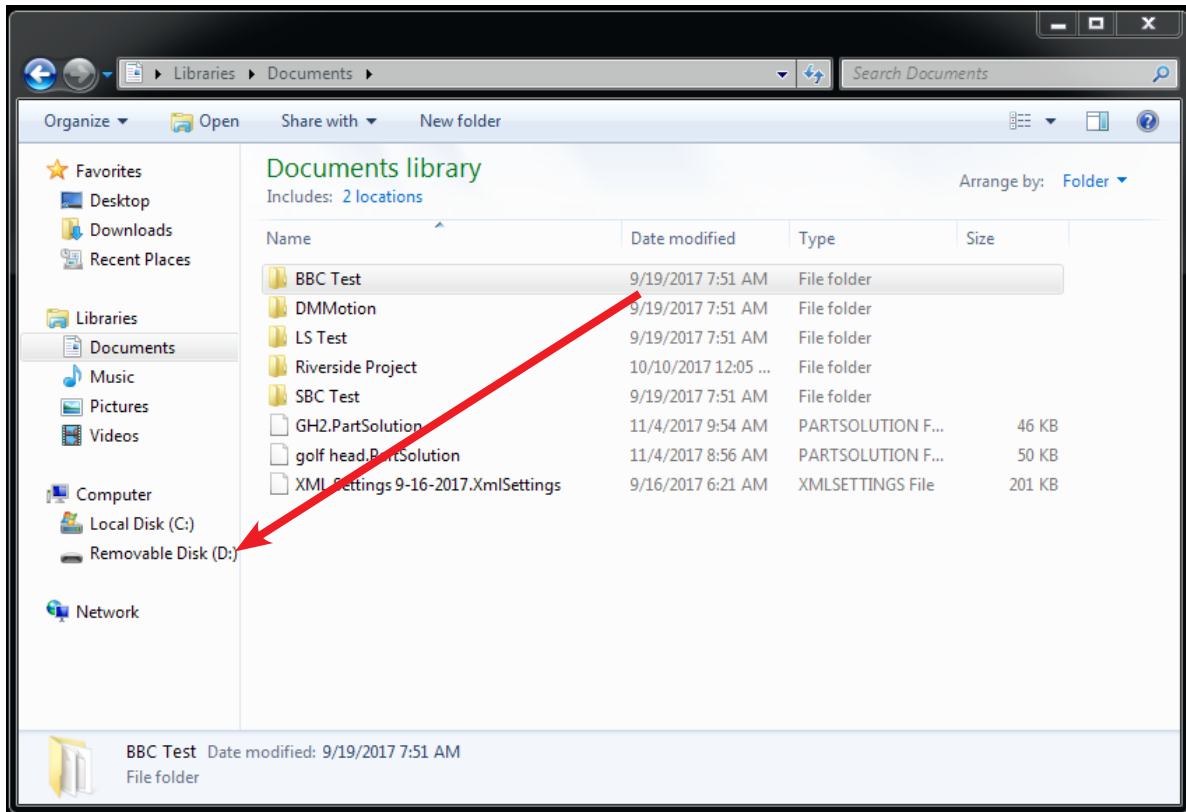

Open the flash drive folder to confirm that all program files have been copied to the flash drive. Close the window and remove the flash drive. Backup is now completed.

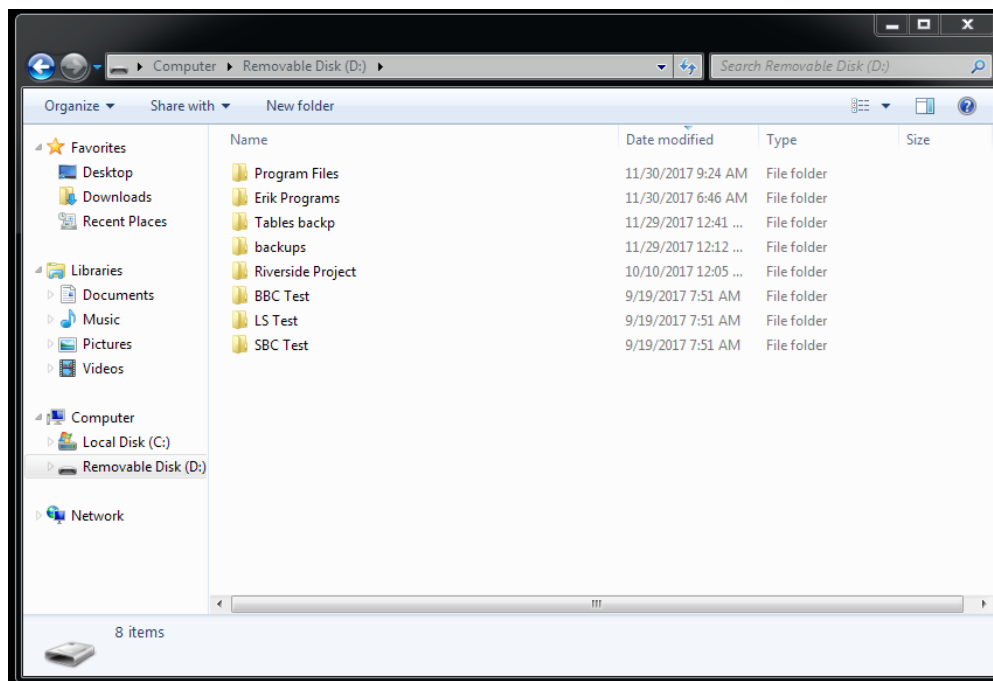

To restore porting programs plug the flash drive with the backups into the usb hub on the side of the monitor housing.

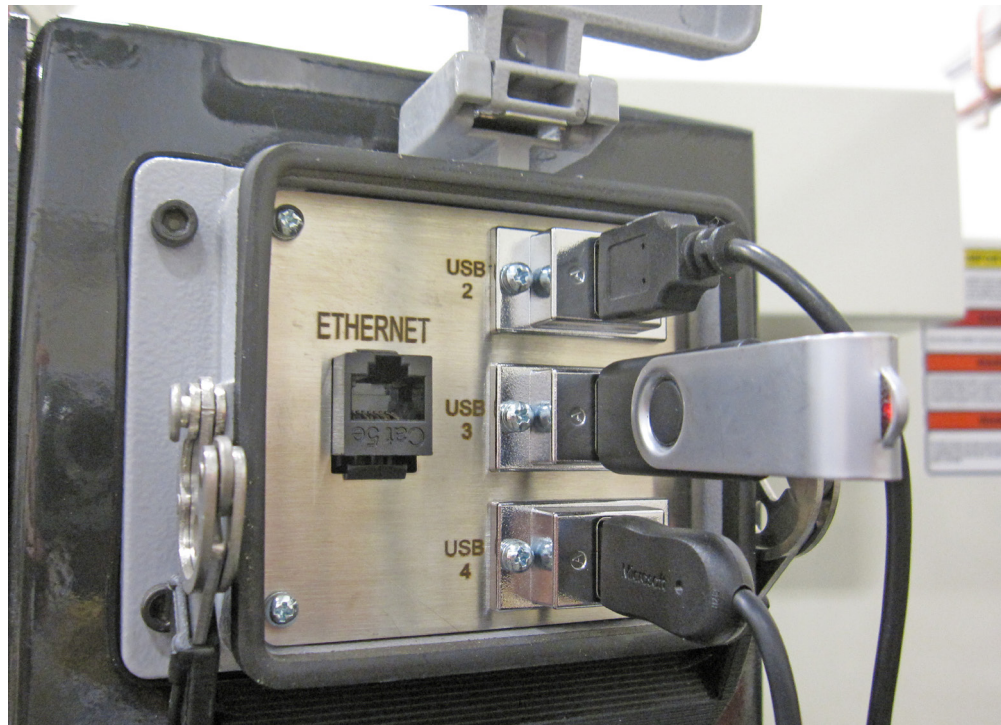

When the AutoPlay window appears, click on Open folder to view files.

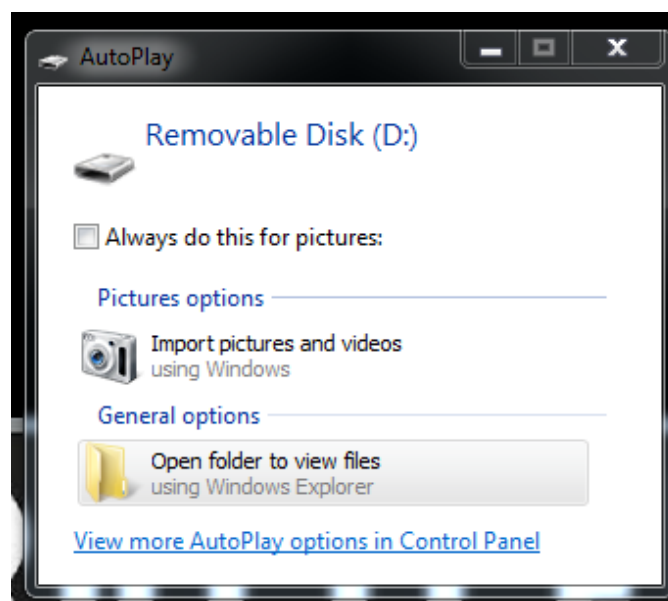

Once the window opens click on the porting files to be restored and drag them to the Documents folder.

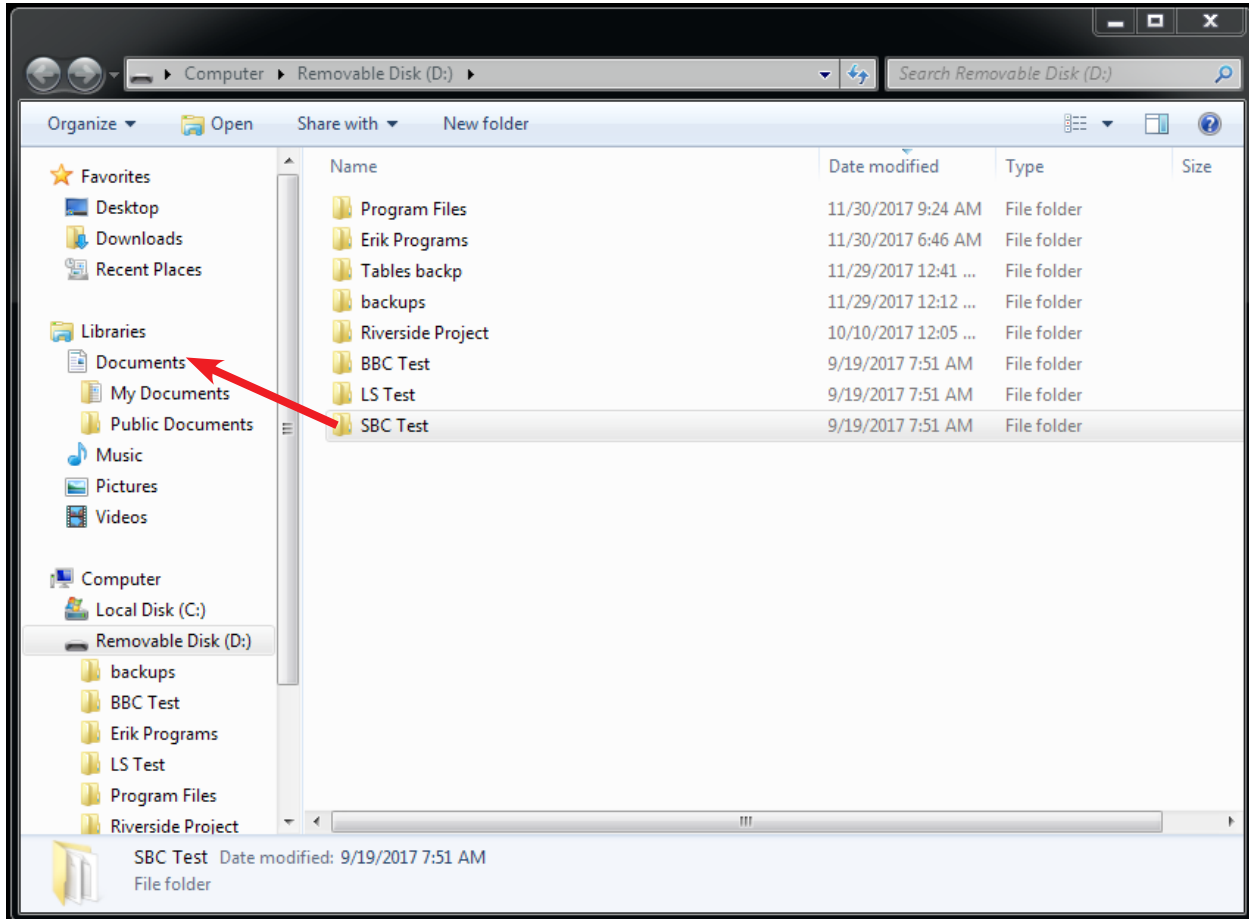

If the Confirm Replace Folder opens up, click Yes.

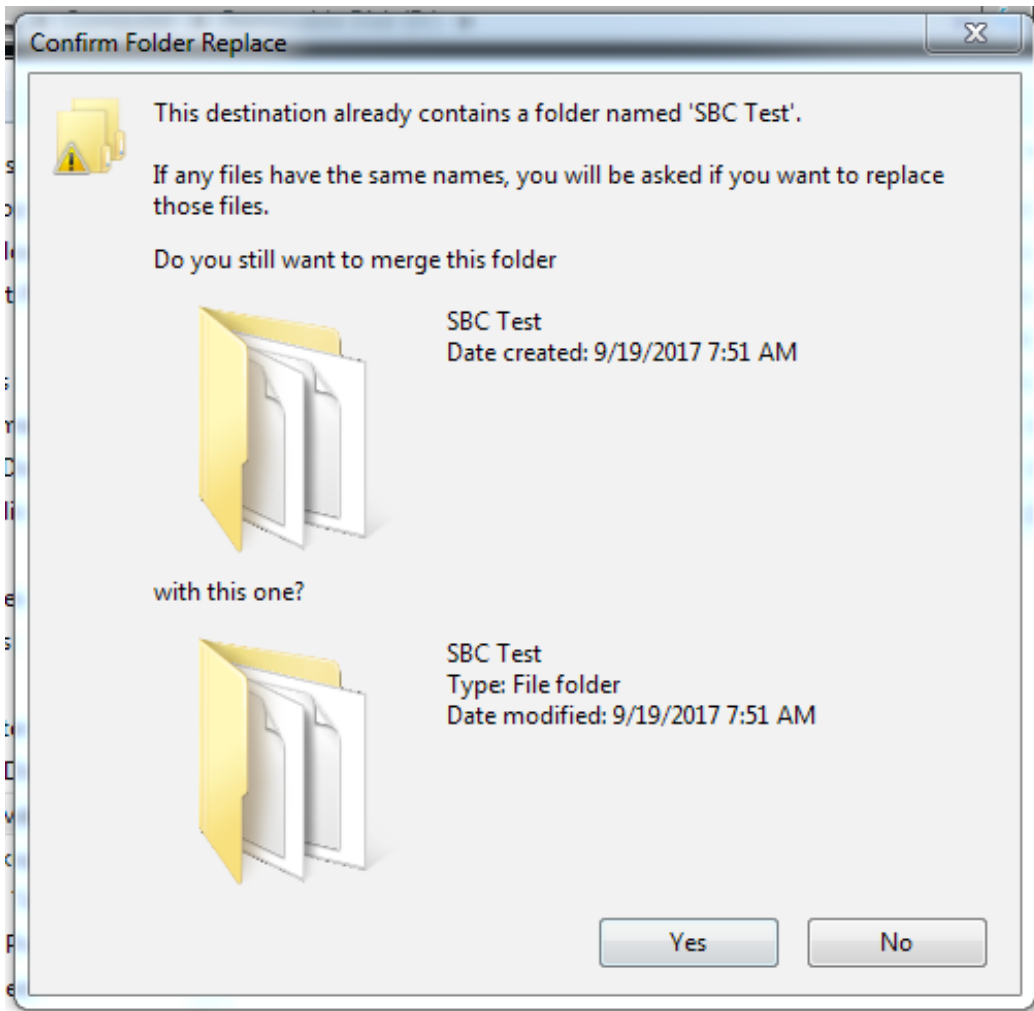

If the Copy File window appears, click on the Copy and Replace option.

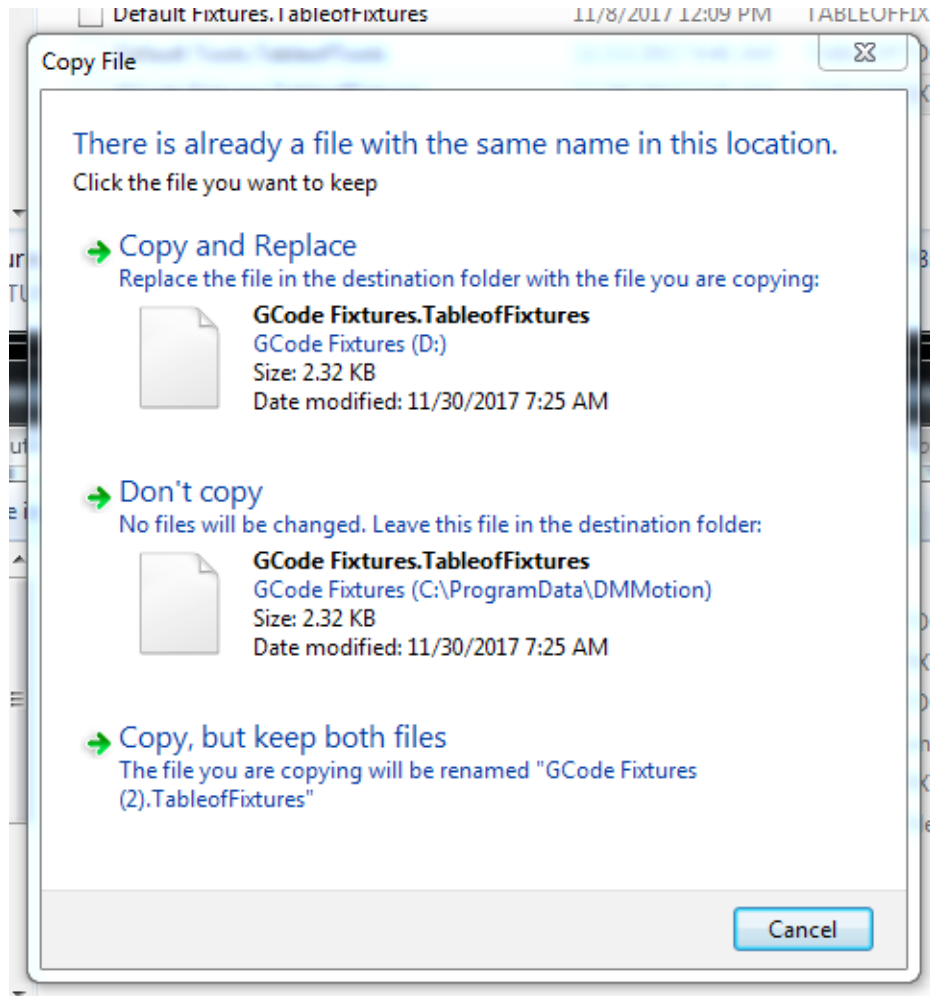

After all the programs have been restored close the window and remove the flash drive.

### Using 3rd Party Tooling in Rottler Machines with CAT 40 Tooling.

When it is not convenient for the customer to order CAT 40 tooling from the factory or if the customer needs tooling that we don't stock, they may purchase tooling from 3rd party vendors such as MSC Metalworking.

Rottler uses a Parlec - A Style, CAT40 Taper, 5/8-11 Thread, 45 Degree Angle Radius, Standard Retention Knob with the following specifications: 1.68 Inch Overall Length, 0.281 Inch Coolant Hole Diameter, 0.74 Inch Knob Diameter, 0.12 Inch Flange Thickness, 0.64 Inch Knob to Flange Length, 0.635 Inch Pilot Diameter, Through Coolant.



The metric equivalent is a Parlec - A Style, BT40 Taper, M16 x 2 Thread, 45° Angle Radius, Standard Retention Knob 1.65 Inch Overall Length, 0.281 Inch Coolant Hole Diameter, 0.74 Inch Knob Diameter, 0.12 Inch Flange Thickness, 0.64 Inch Knob to Flange Length, 0.669 Inch Pilot Diameter, Through Coolant.



This page intentionally left blank



# MAINTENANCE

## Contents

<b>Maintenance.....</b>	<b>6-1</b>
Quick Reference Lubrication Chart: P69AHD.....	6-1
Quick Reference Preventative Maintenance: P69AHD.....	6-2
<b>Scheduled Maintenance Procedures.....</b>	<b>6-5</b>
Long Break-In Cycle.....	6-5
Quick Warm-Up Cycle.....	6-6
Setting the B-Axis Air Pressure.....	6-7
Empty Water Traps.....	6-8
Check Way Oil (Level).....	6-9
Clean Spindle Chiller Air Filter.....	6-10
Check Way Oil (Functionality).....	6-11
Way Cover Maintenance.....	6-14
Check Spindle Chiller Level and Settings.....	6-15
Check Drawbar Oil Level.....	6-16
Replace Coolant.....	6-17
<b>Lubrication.....</b>	<b>6-18</b>
Automatic Lubrication System.....	6-18
Power Draw Bar Lubrication.....	6-18
A & B-Axis Gearbox Lubrication.....	6-18
Vertical Ballscrew Bearings.....	6-18
Probe “On-Center” Adjustment.....	6-19
<b>Leveling and Alignment.....</b>	<b>6-20</b>
Leveling the Machine.....	6-20
Alignment.....	6-21
Middle Leveling Bolts.....	6-24

**Vertical Gib Adjustment ..... 6-26**  
    **Tightening Gibs.....6-26**  
    **Loosening Gibs.....6-26**  
**Replacing the Motherboard Battery..... 6-27**

## Maintenance

### Quick Reference Lubrication Chart: P69AHD

Refer to the maintenance section in the manual for lubrication location points and instruction.

<b>Assembly</b>	<b>Frequency Hours</b>	<b>Lube Operation</b>	<b>Recommended Lubricant</b>	<b>Date Serviced</b>
Way Oil Level	40	Fill as needed	Conoco Brand 76 Way Oil HD 68 or ISO VG 68 equivalent	
Drawbar oil level	160	Fill as needed		

**Quick Reference Preventative Maintenance: P69AHD**

Refer to the procedures in the maintenance section of the manual to make or check these adjustments. ***Not all of the items listed in the table below have adjustment.*** The information should be recorded and the amount of wear tracked so the part can be replaced before down time on the machine occurs.

Procedure	Frequency Hours	Date Serviced/Comments
Long Break-In Cycle	Variable	
Quick Warm-Up Cycle	Daily	
Empty Water Traps	40	
Clean Spindle Chiller Air Filter	40	
Check Way Oil Functionality	160	
Visually Inspect Way Covers	160	
Check Spindle Chiller Level and Settings	160	
Replace Coolant	480	
Check Air Pressure Regulators	480	
Check Backlash	960	
Check Gibbs	960	
Check Home Presets	960	
Check for Loose Bolts	960	
Check Machine Geometry	960	
Check Incoming Voltage	960	
Flush Coolant System	1920	

Removable copy

**Quick Reference Lubrication Chart: P69AHD**

Refer to the maintenance section in the manual for lubrication location points and instruction.

<b>Assembly</b>	<b>Frequency Hours</b>	<b>Lube Operation</b>	<b>Recommended Lubricant</b>	<b>Date Serviced</b>
Way Oil Level	40	Fill as needed	Conoco Brand 76 Way Oil HD 68 or ISO VG 68 equivalent	
Drawbar oil level	160	Fill as needed		

**Quick Reference Preventative Maintenance: P69AHD**

Refer to the procedures in the maintenance section of the manual to make or check these adjustments.

**Not all of the items listed in the table below have adjustment.** The information should be recorded and the amount of wear tracked so the part can be replaced before down time on the machine occurs.

Procedure	Frequency Hours	Date Serviced/Comments
Long Break-In Cycle	Variable	
Quick Warm-Up Cycle	Daily	
Empty Water Traps	40	
Clean Spindle Chiller Air Filter	40	
Check Way Oil Functionality	160	
Visually Inspect Way Covers	160	
Check Spindle Chiller Level and Settings	160	
Replace Coolant	480	
Check Air Pressure Regulators	480	
Check Backlash	960	
Check Gibbs	960	
Check Home Presets	960	
Check for Loose Bolts	960	
Check Machine Geometry	960	
Check Incoming Voltage	960	
Flush Coolant System	1920	

## Scheduled Maintenance Procedures

### Long Break-In Cycle

A Long Break-In Cycle should be completed whenever any of the following criteria has been met:

- The machine has been transported
- The Spindle has not been run for 7 or more consecutive days
- The spindle has been left out of position (more than 20 degrees from '0') for 8 or more consecutive hours

The Long Break-In Cycle is a process that takes approximately 3 hours and 55 minutes. During this cycle the spindle must be at the '0' position and clear of any objects. It is necessary that the spindle chiller is functioning and air pressure is supplied to the machine. The spindle will then cycle through a series of RPM changes and pauses to properly distribute grease throughout the bearings.

The Long Break-In Cycle can be located in the Direct Path or Direct Surface Programs in the Menu Bar at the top of the screen under; Spindle Warmup Cycles>Long Break In Cycle



Once the cycle has been completed, the machine can be operated normally.



## Quick Warm-Up Cycle

The Quick Warm-Up Cycle must be completed every day before the machine is operated. The Quick Warm-Up Cycle lasts approximately 30 min. . During this cycle the spindle must be at the '0' position and clear of any objects. It is necessary that the spindle chiller is functioning and air pressure is supplied to the machine. The spindle will then cycle through a series of RPM changes and pauses to properly distribute grease throughout the bearings and increase the internal temperature to an acceptable level.

The Quick Warm-Up Cycle can be located in the Direct Path or Direct Surface Programs in the Menu Bar at the top of the screen under; Spindle Warmup Cycles>Quick Warmup.



Once the cycle has been completed, the machine can be operated normally.

### Setting the B-Axis Air Pressure

1. Rotate the spindle to 45 degrees.
2. Place something under the spindle so if it falls, it does not damage anything. A wood block is perfect.
3. Push the E-Stop.
4. If the spindle falls, it needs more pressure, if it rises, it needs less pressure
  - A. If it needs less air, you will need to release the pressure from the reservoir tank, (3) as it has a one way check valve, (2) then adjust the regulator (1) pressure to where it needs to be.
  - B. Older machines don't have the one way check valve, so previous step is not necessary.
5. Adjust the valve that controls the pressure to the B axis accordingly.
6. Repeat this process until the spindle does not move when pressing the E-Stop in

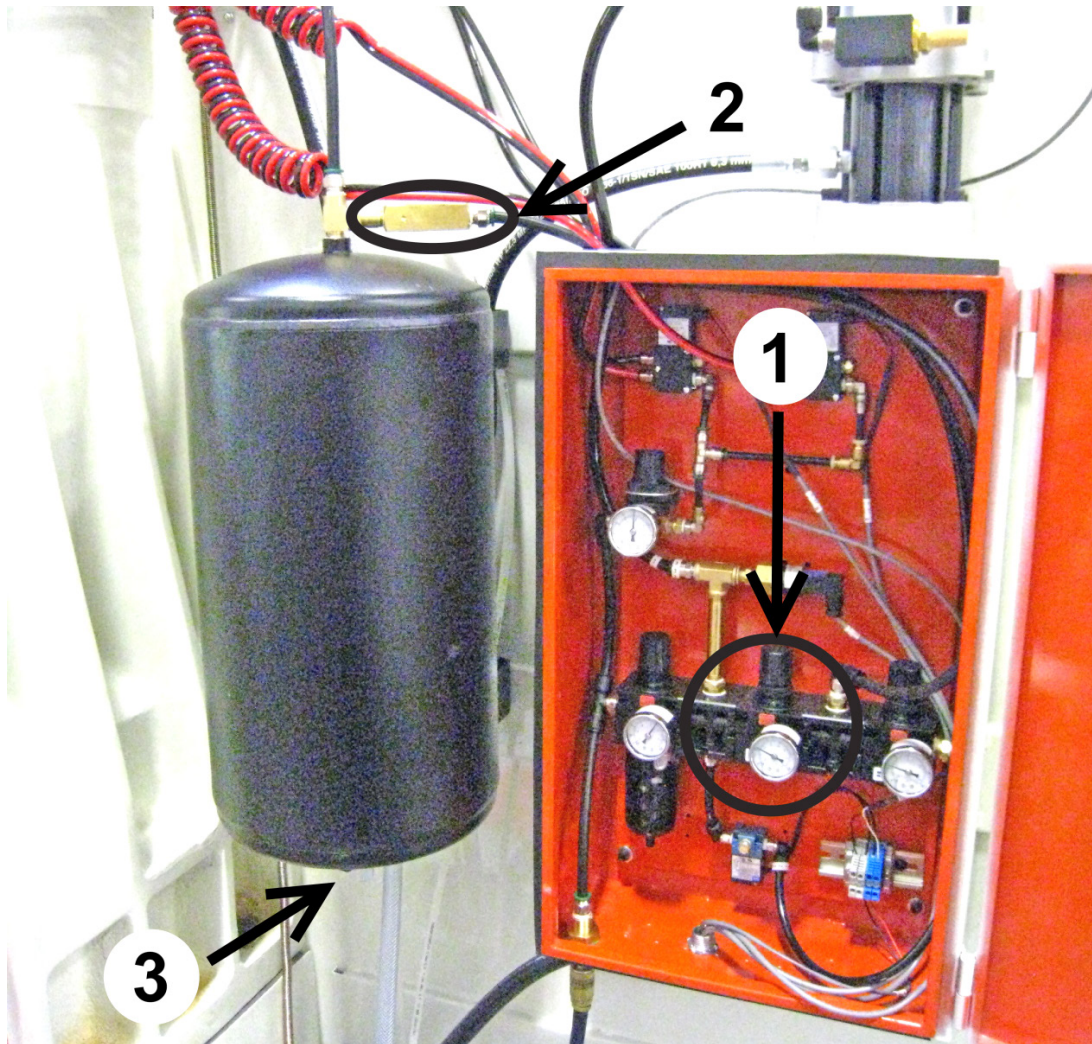

## Empty Water Traps

The P69AHD is equipped with 2 water traps. The first water trap is located on the main pressure regulator. This water trap has a float that allows it to self-purge whenever water builds up inside of the trap.

The second water trap is located to the left of the Air Cabinet. This trap should be emptied every week to prevent moisture buildup in the air system that could potentially cause rust accumulation and blockages. At the bottom of this black air reservoir there is a ball valve used to relieve air pressure and moisture.

While emptying the water trap, the B axis must be in the '0' position. Failure to do this can cause a drop of air pressure in the system substantial enough to allow the spindle motor to fall to one side and overextend the tilt assist, causing permanent damage. With air pressure still applied to the machine; open the valve for at least 10 seconds then return it to the closed position.

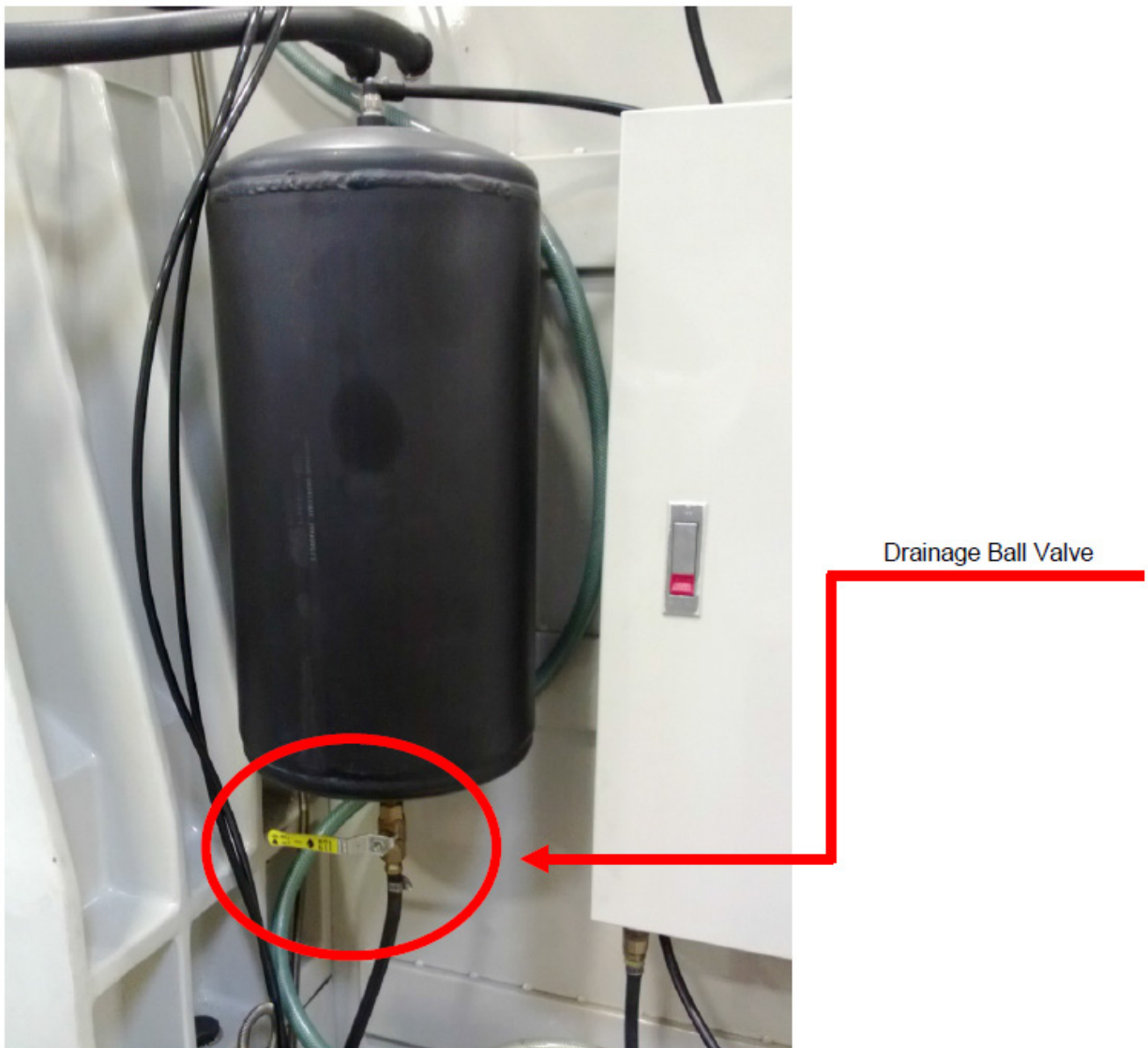



## Check Way Oil (Level)

This machine uses **ISO VG 68 Way Oil** to lubricate all moving components. This way oil is contained in a reservoir on the rear of the machine. The reservoir also serves as a pump that is activated for a predetermined amount of time (approximately 30 seconds) after the machine has moved a designated distance (approximately 13,000 inches.) The level of the way oil should be checked weekly.

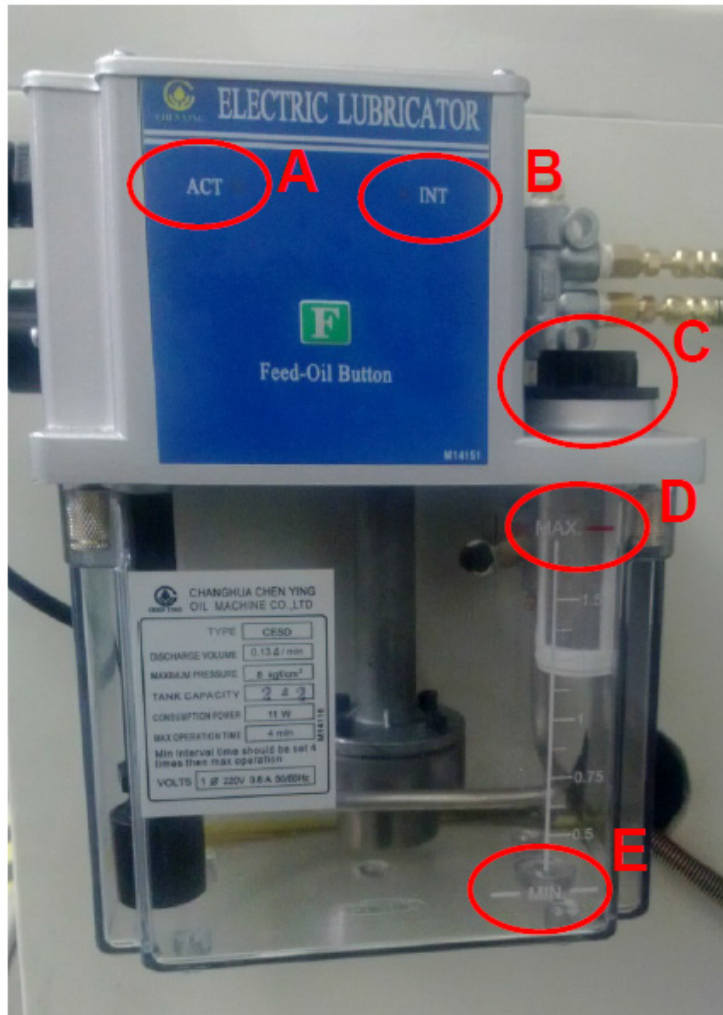

- A) An LED indicates that the oiler is being supplied power and is currently active.
- B) An LED indicates that the oiler is being supplied power but is not currently active.
- C) This is the fill cap for the oiler. Be sure the filter is in place while filling.
- D) This is the maximum amount of oil allowed in the oiler. DO NOT OVERFILL. Overfilling can cause permanent pump damage.
- E) This is the minimum amount of oil allowed in the oiler. DO NOT ALLOW TO EMPTY. An empty reservoir can cause permanent pump damage.

### Clean Spindle Chiller Air Filter

It is important to clean the air filter of the spindle chiller every week. Failure to do so could cause chiller failure.



- 1) Dismount the air filter.
- 2) Blow dust from the cooling fins using compressed air.
- 3) Clean dust from the air filter with water or compressed air in the reverse flow.
- 4) Remount air filter.

### Check Way Oil (Functionality)

This machine uses Multipurpose Way Oil to lubricate all moving components. This way oil is contained in a reservoir on the rear of the machine. The reservoir also serves as a pump that is activated for a predetermined amount of time (approximately 30 seconds) after the machine has moved a designated distance (approximately 13,000 inches.) The functionality of the oil pump should be checked weekly.

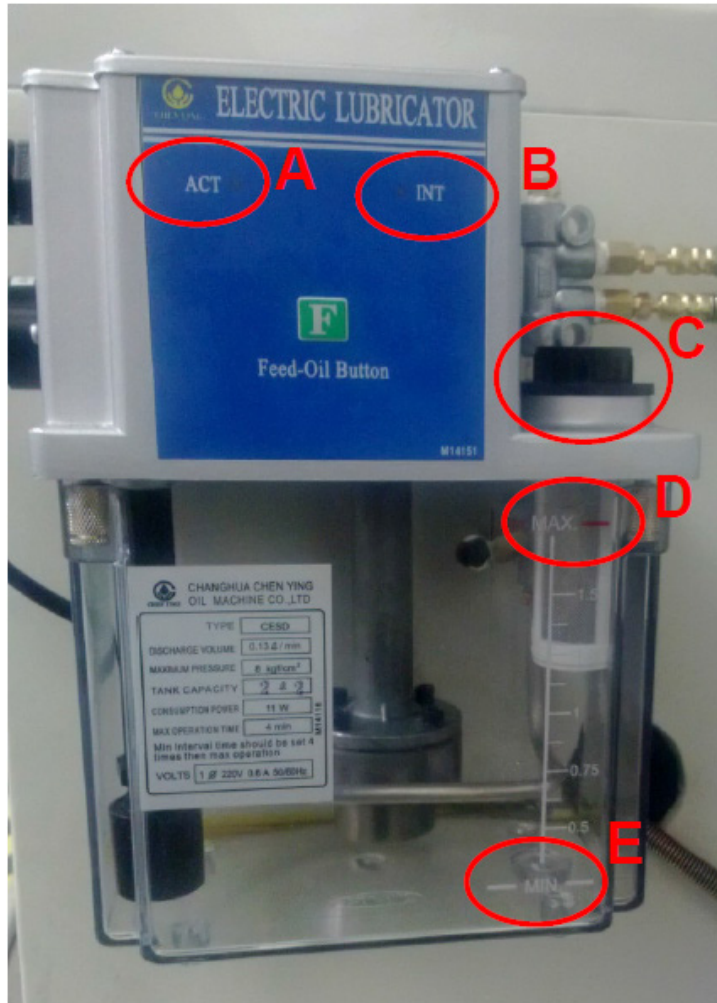

A) An LED indicates that the oiler is being supplied power and is currently active.

B) An LED indicates that the oiler is being supplied power but is not currently active.

C) This is the fill cap for the oiler. Be sure the filter is in place while filling.

D) This is the maximum amount of oil allowed in the oiler. DO NOT OVERFILL. Overfilling can cause permanent pump damage.

E) This is the minimum amount of oil allowed in the oiler. DO NOT ALLOW TO EMPTY. An empty reservoir can cause permanent pump damage.

To check the functionality of the pump, go to Setup > I/O.



Expand the “Oiler Addin” section and double-click on “Oiler.”

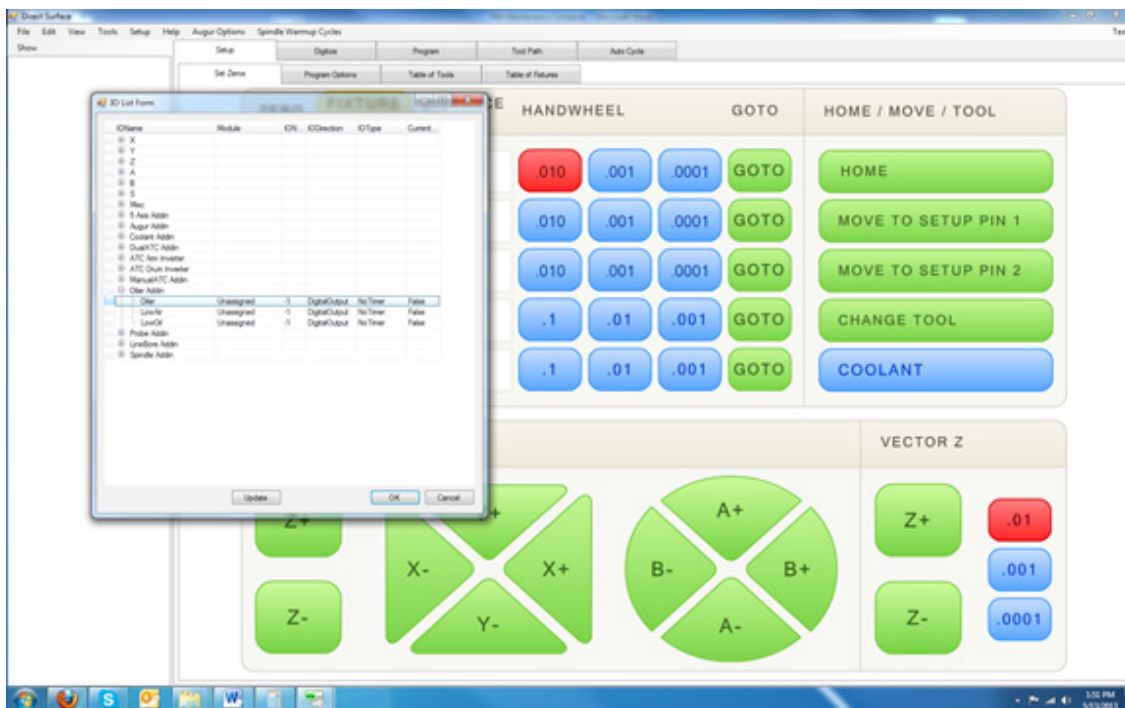

Click on the “Chane State” button ONE TIME. This will apply power to the oiler at the rear of the machine. Once you have done this, walk to the rear of the machine (within 30 seconds) and check that the pump is operating by visually observing the “ACT” LED is on.



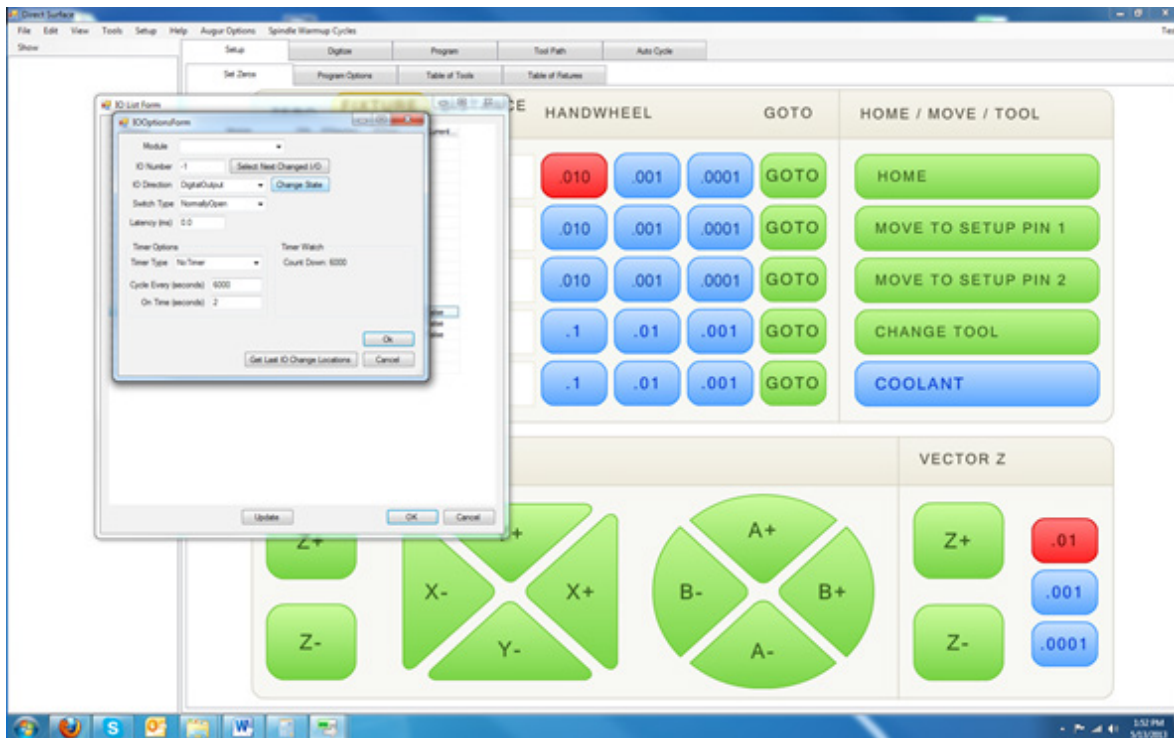

Once you have verified that the oil pump is active, return to the monitor and click the “Change State” button one time to release power from the oiler. Visually check the oiler to verify that power has been released. Close all setup windows.

If the “ACT” LED is not on but the “INT” LED is, remain in the rear of the machine and have someone else press “Change State” button one time to turn off the “INT” LED, then once more to turn the power back on. The “ACT” LED should come on and stay active for approximately 30 seconds. If it does, return to the monitor and click the “Change State” button one time to release power from the oiler. Visually check the oiler to verify that power has been released. Close all setup windows.

If the “ACT” LED does not illuminate at all, or is illuminated for less than 20 seconds, please contact a Rottler Manufacturing technician for further assistance.



## Way Cover Maintenance

Way covers should be inspected weekly. Move table to limit of its travel on each side and clean any chips from the covers. It is important to keep all way covers in good working condition. Doing this will allow the way covers to keep coolant and dirt from entering the ways and dramatically reduce wear on the machine. You should visually inspect the X axis way covers to the left and right of the table, Y axis way covers on the front and rear of the table, and the Z axis way cover under the spindle base. The ways should be free of rust and the seals should be in contact with the way cover for the entire width of the seal.

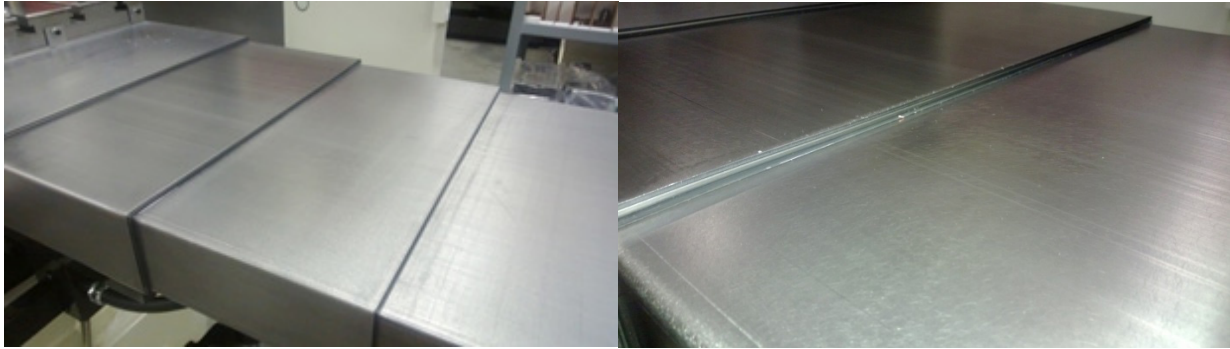

Fully extend the way cover being inspected and wipe clean with WD-40 (or a similar lubricant). If there is rust on the way cover, coat a Scotch-Brite pad with WD-40 and gently clean the surface in a circular motion until the rust is removed. Wipe clean with WD-40 after completed.

If any of the seals are damaged or the way covers are dented in a way that doesn't allow them to seal for the entire width of the way and throughout travel, the way cover must be repaired or replaced. Please contact a Rottler Manufacturing technician to obtain replacement parts.

## Check Spindle Chiller Level and Settings

The spindle on this machine is equipped with an oil chiller unit. This oil chiller acts as a reservoir and a temperature regulator for the spindle. Once per month the chiller should be checked for proper settings and oil levels.

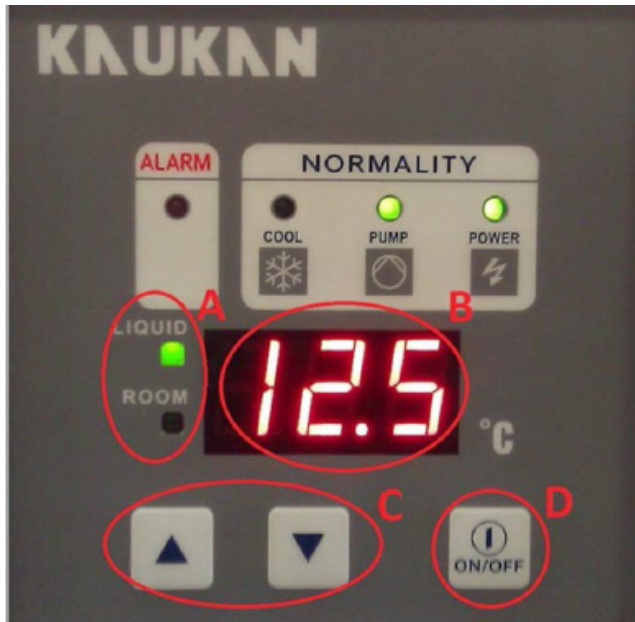

- A) Indicates whether the number displayed is room or oil temperature.
- B) Celsius reading of temperature.
- C) Allows you to change temperature settings of the oil chiller.
- D) Toggles the temperature display between oil and room temperature.

To check the temperature settings, first press the ON/OFF button until the "ROOM" LED is illuminated. This will display the room temperature in Celsius. Next, hold either of the 'up/down' buttons until the numbers on the display flash. They will display a number between 15 and -15. This number indicates the target oil temperature in comparison to the room temperature. For best results this number should display 3.0 in a room that has an average temperature of 19.5 degrees(C) or lower, or -3.0 in a room that has an average temperature of 20 degrees(C) or higher. Press the "ON/OFF" button to save any changes.

The oil level sight glass is located on the bottom of the oil cooler. This also has a mercury thermometer in it to indicate oil temperature. This sight glass should be filled to the black line at the top. If the oil is not filled to the black line it must be topped off with air tool oil. The oil fill can be reached by removing the air filter and two Phillips head screws located above the panel labeled "SUPPLY."



### Check Drawbar Oil Level

Once per month the oil level in the drawbar should be checked. If the oil level gets too low it can cause permanent damage to the drawbar. The drawbar on the P69AHD is mounted to the top of the air cabinet on the rear of the machine. The reservoir is a clear container on the side of the drawbar. It should be filled to the top line with clean tool oil. If it is not, simply remove the cap, refill, and replace the cap.

If the reservoir is ever completely empty during this check please contact a Rottler Manufacturing technician for trouble shooting procedures.

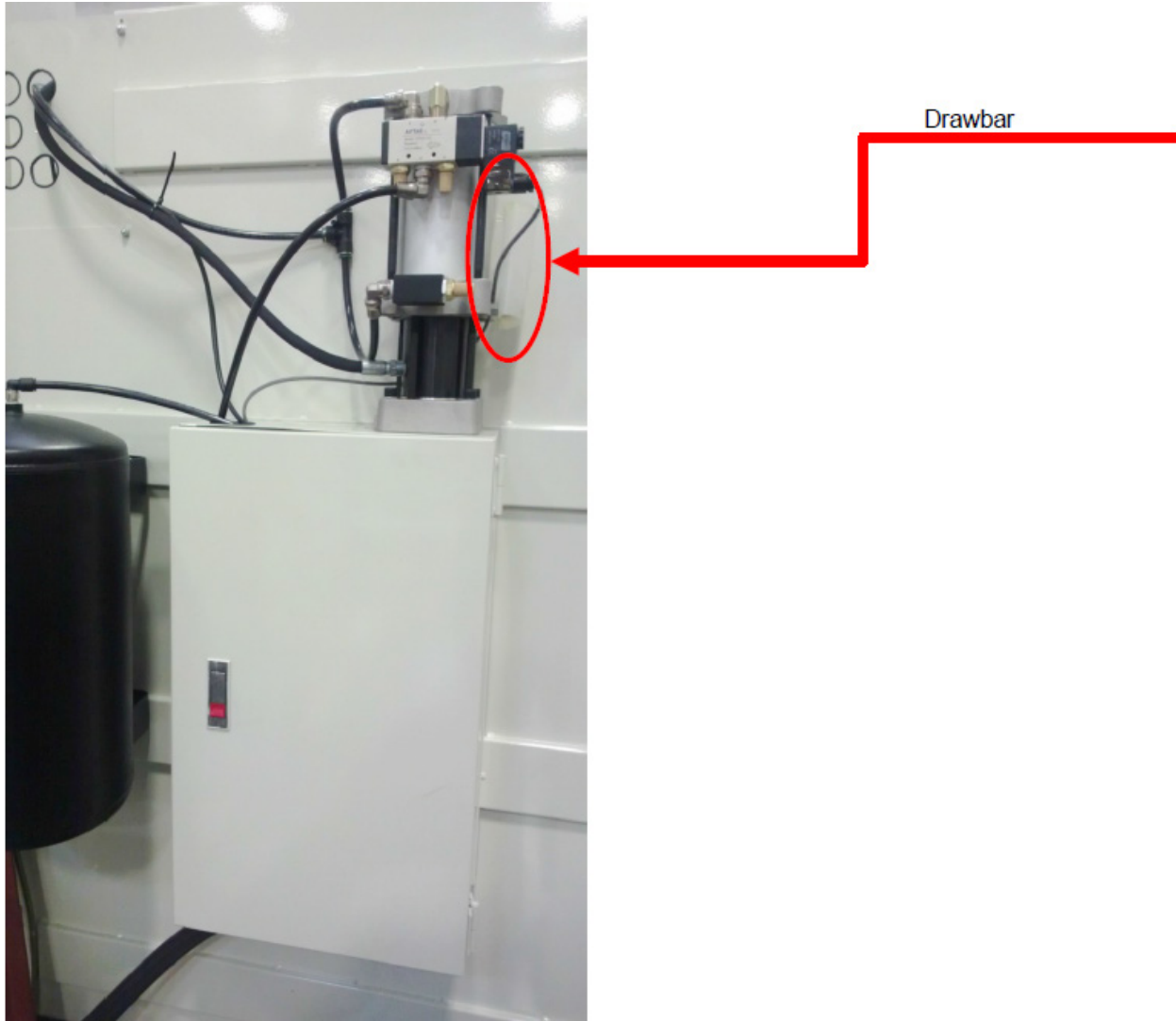

## Replace Coolant

It is imperative that the coolant in the machine retains all of its lubricating properties. If it fails to do this it can cause the machine to rust in inaccessible areas, and cause permanent machine damage. The coolant should always be mixed according to the coolant manufacturer's specifications. (Generally near a 10:1 water to coolant solution mixture.)

To replace the coolant in the machine you may either install a petcock in the drainage plug in the rear of the coolant tank, or remove it via a pump/vacuum from the top of the tank where the coolant pump is located. Due to the baffle system within the coolant tank, this may leave sediment in the bottom of the tank. If machining a lot of ferrous metals it may be necessary to clean this sediment out by removing the cover of the coolant tank. (Remember; the coolant from this machine may be considered "hazardous waste." Please check with local laws and dispose of the coolant accordingly.)

Refill the coolant tank with water/coolant mixture until it is near the top of the lowest point on the coolant tank. (Usually the coolant pump housing.)

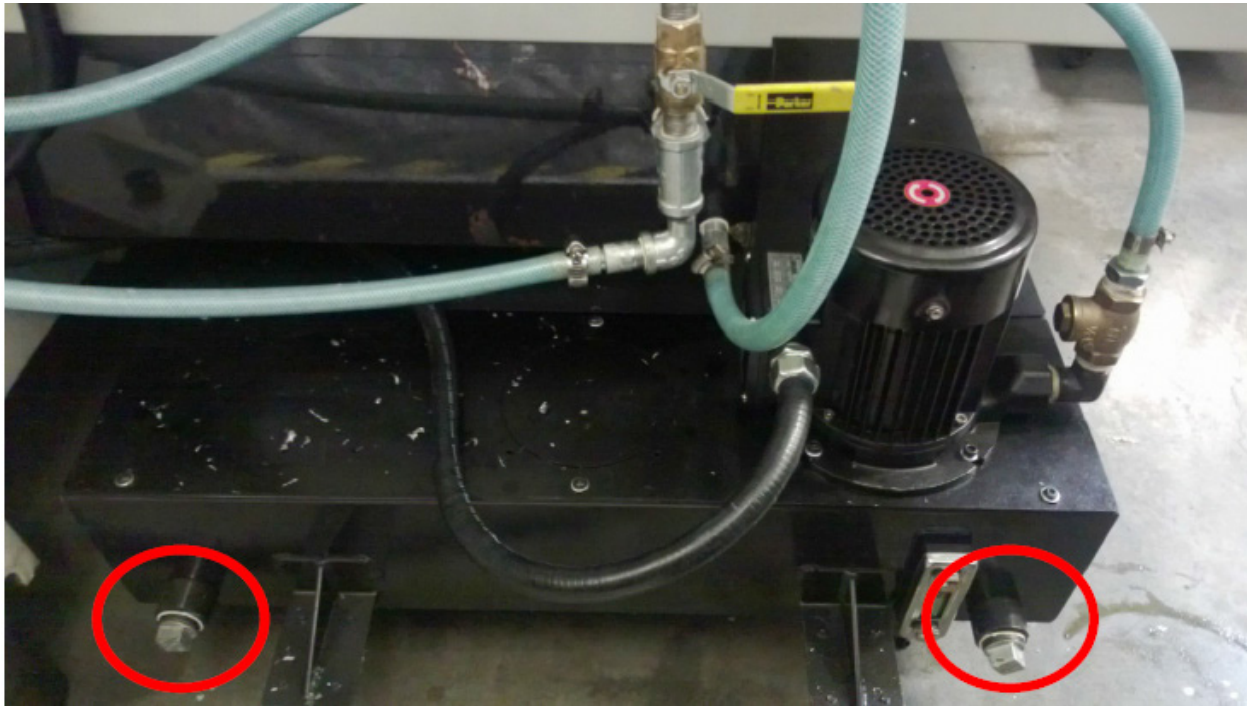

## Lubrication

### Automatic Lubrication System

The automatic lubrication system includes metering valves for proportional distribution and includes an alarm for low fluid level warning. Still, please check fluid level before operation. Add **Union 76 Way Oil HD-68**, or equivalent, as needed in reservoir at rear of machine.

### Power Draw Bar Lubrication

The Power Draw Bar assembly needs to have oil supplied in the air line to it. Use machine tool oil in this reservoir. The reservoir is located on the back of the main column of the machine. Refer to the following illustration for filling location.

### A & B-Axis Gearbox Lubrication

The A & B-Axis gearboxes should be greased on a weekly basis. Fill with grease weekly ensures that any coolant that may have seeped into the gearbox is forced out when grease is pumped into the gearbox. Remove the plug and cover plate located on the spindle base. Add grease at the grease fitting until there is overflow coming out of hole where cover plate was removed. Remove excess grease and replace cover plate. Continue to add grease until there is overflow coming out of the plug hole. Remove excess grease and replace plug.

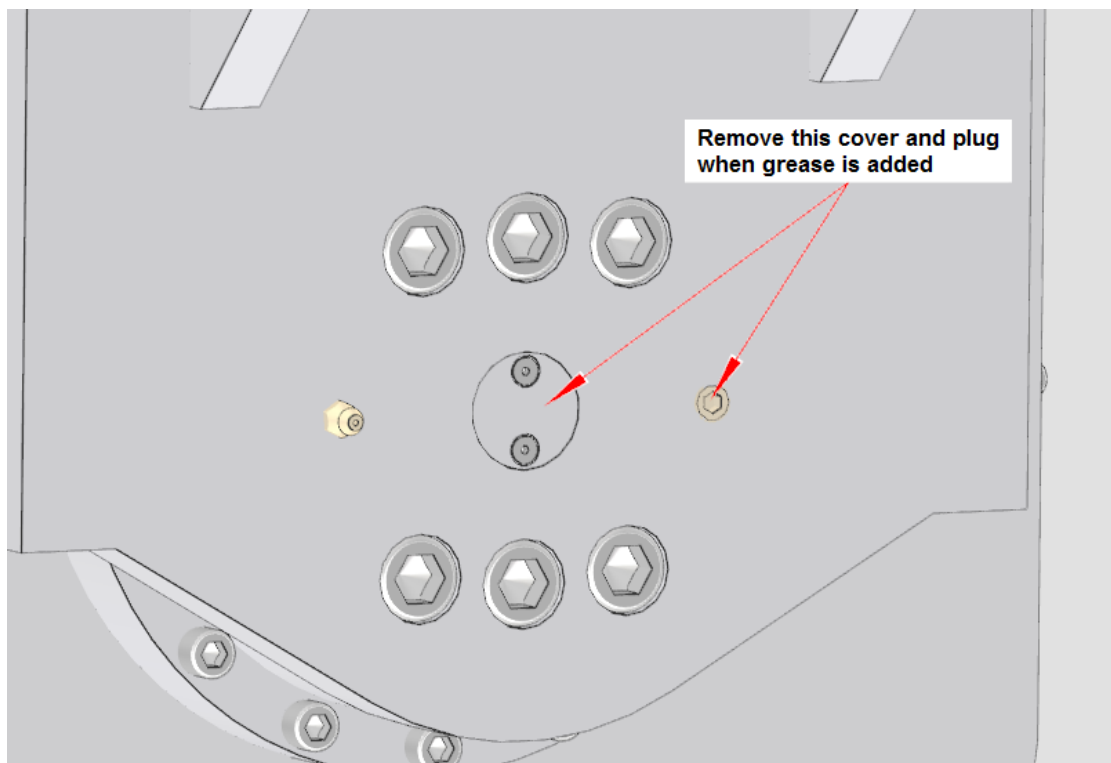

### Vertical Ballscrew Bearings

#### Every 175 Hours:

These bearings should be greased with **Unoba EP 2 Multi Purpose Grease or equivalent NLGI 2 grease**.



### Probe “On-Center” Adjustment

The optional shank adapter assembly allows the OMP40 to be mounted on shanks suitable for the MP10, MP12 and MP700 Probes.

#### Step 1 - Adapter Assembly:

Assemble the 650-3-59H adapter plate as shown. Fully tighten screw A to 0.68 ft. lb. (3.0 Nm)

#### Step 2 – Probe / shank Mounting:

Fully loosen all screws and fit shank adapter to shank as shown on the following page. Tighten screw B to 1.35 ft. lb. (6 Nm)

Fully tighten screw C to 0.49 ft. lb. (2.2 Nm)

Fit Probe / Shank assembly into machine spindle.

#### Step 3 – Adjustment:

There are four screws D. Each will move the probe relative to the shank in the X or Y direction as pressure is applied. Tighten screw individually, backing off after each movement.

Use screws D in opposition at the same time to move the probe, progressively tightening then as the final setting is approached. Use two Allen keys if needed. Tip run out should be .002” (5 Microns) should be achievable.

It is important that all four screws (D) are tightened to 0.49 ft. lb. (2.2 Nm) once the final setting has been achieved.

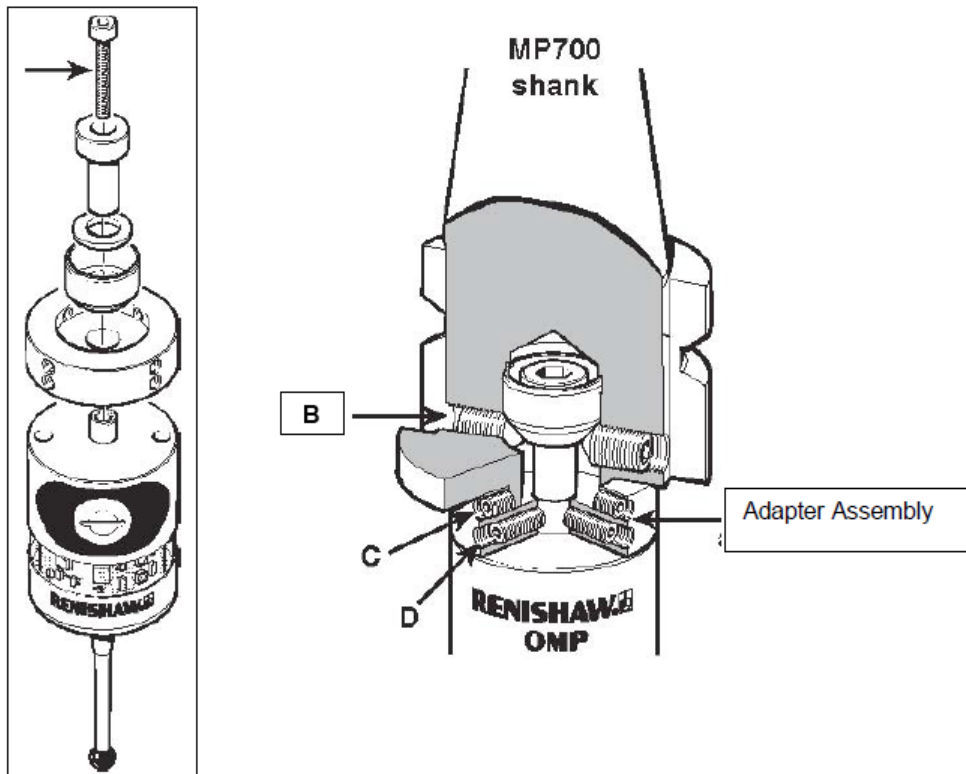

## Leveling and Alignment

The following is a description of how to properly level and align the F69A machine. These procedures should be followed in the order they written to obtain correct machine level and alignment.

### Leveling the Machine

After uncrating the F69A set it down in desired location with leveling bolts and leveling pads installed.

Remove the Y-Axis protective rubber located on the backside of the table. This is where you will position the level to level the machine. A .0005" increment per foot precision level is required.

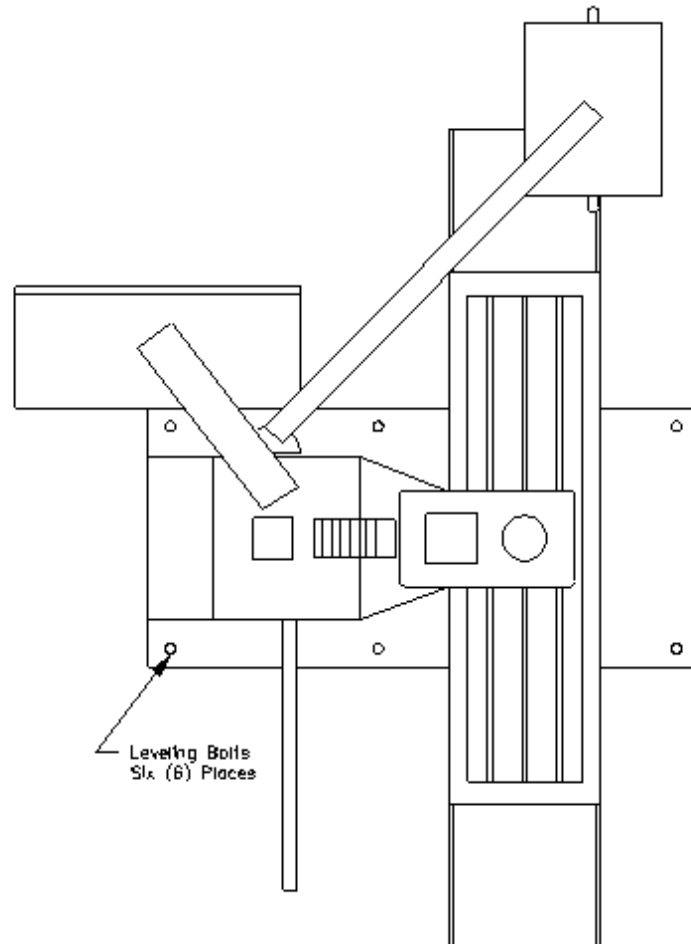

Using the four (4) corner leveling bolt to start with, bring the machine up to level in both directions (front to back and left to right) within .0005" per foot.

After you have leveled the bed using the four corner bolts, move to the middle leveling bolts. Bring these bolts down until they have approximately the same amount of pressure on them as them as the four corner bolts. Be careful not to throw the level of the machine off while doing this.

This will put the lower casting level.



## Alignment

Place the alignment cylinder on the table in roughly the same position as shown on the following page.

Note: The position (angle) of the probe to the surface you are indicating is critical. Using an incorrect angle on the probe will result in inaccurate readings from the surface being indicated. The angle of the probe should be at about 15 degrees from the surface being indicated (see illustration 2).

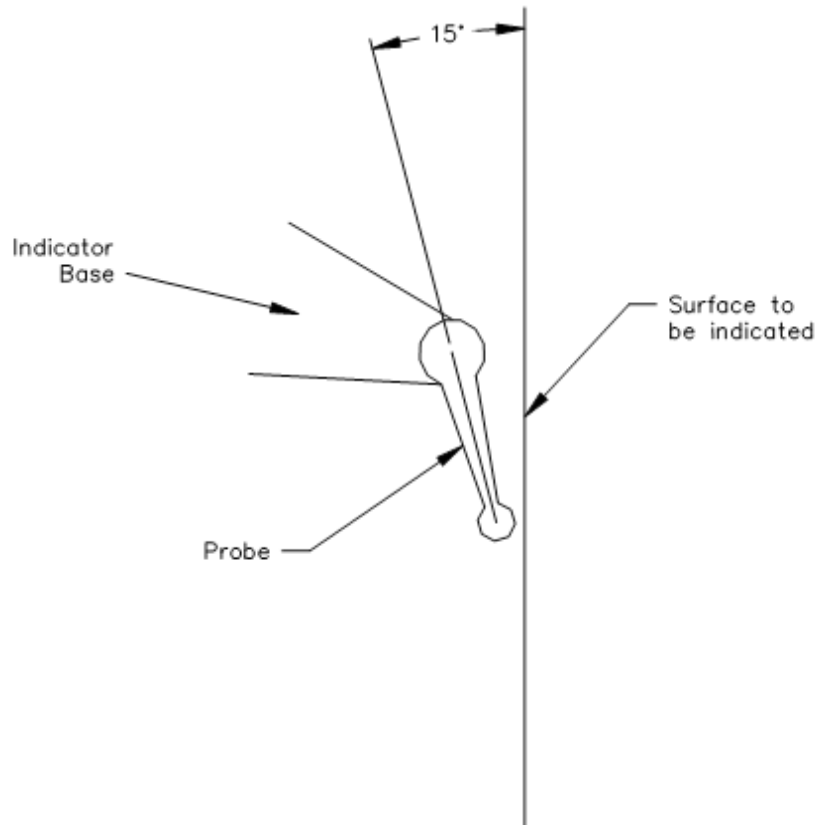

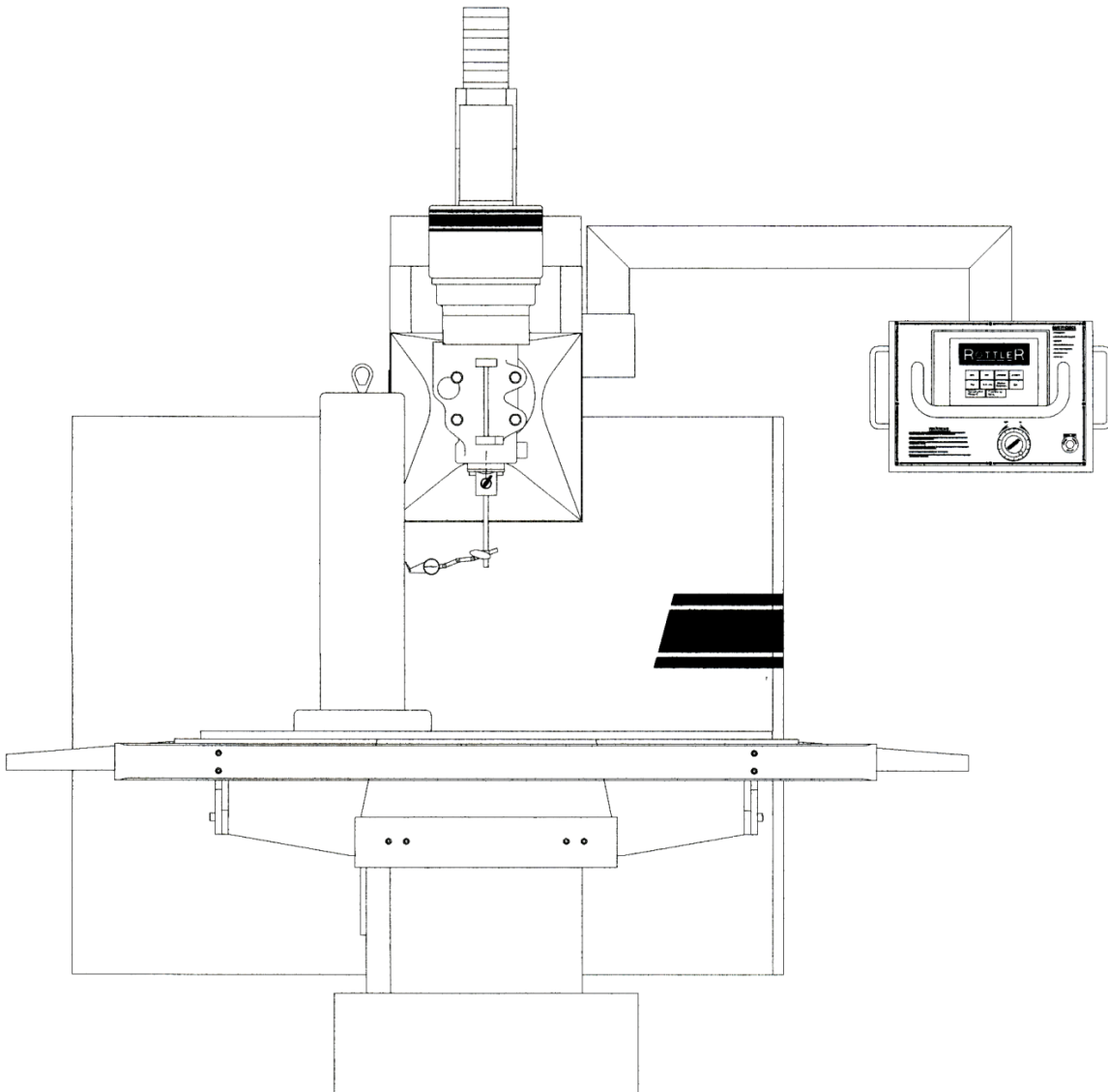

Put about .010" pressure on the indicator. Run the vertical throughout its full travel. The runout should not be more than .0005. If the runout is more than this, check the table top as well as the bottom of the alignment cylinder for burrs or debris.

Move the table out and check the perpendicularity of the vertical ways. This should be within .0005".

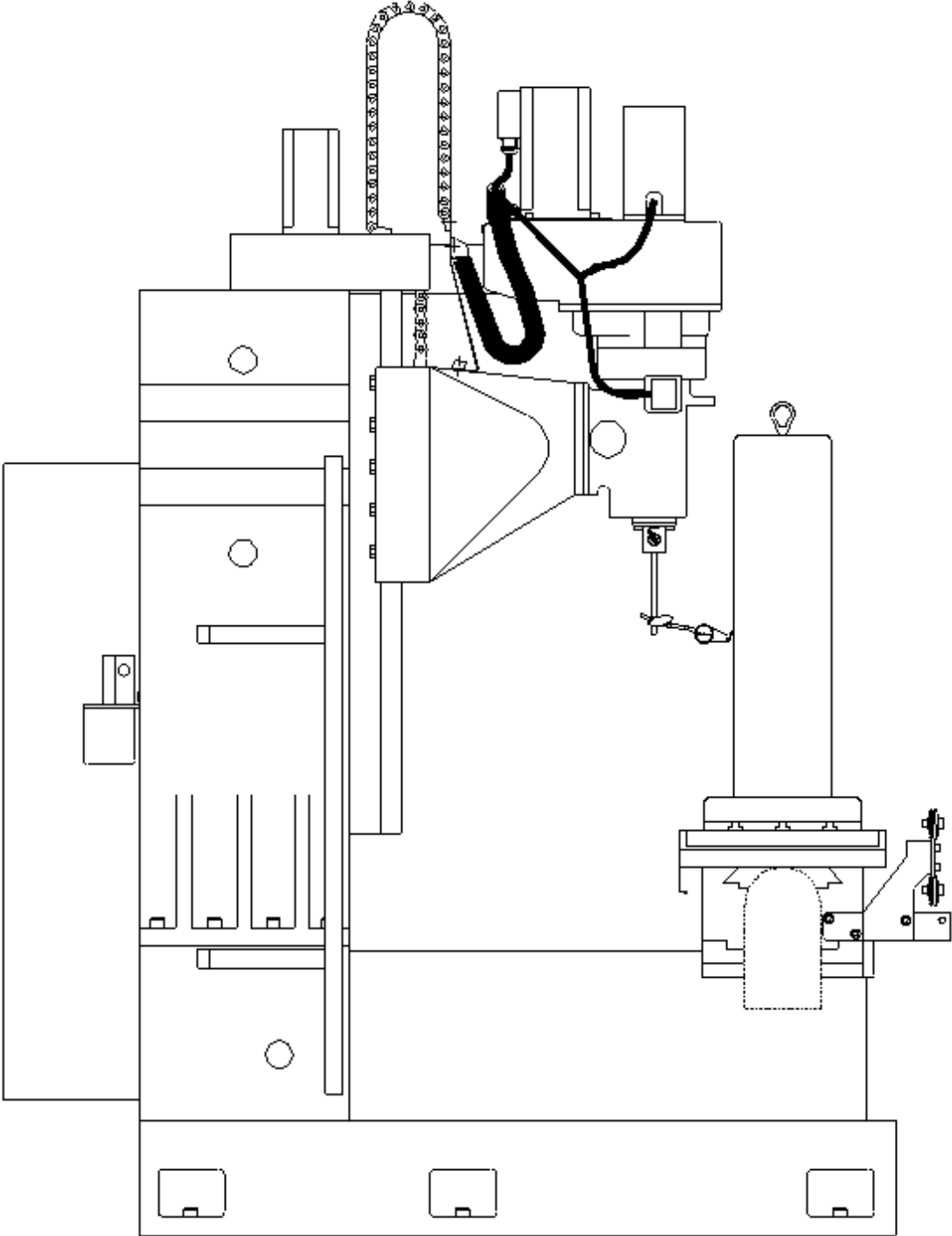

If the Vertical perpendicularity is not within tolerance the Middle Leveling Bolts may need to be adjusted.

### Middle Leveling Bolts

If the procedures for the Leveling was followed correctly, it is unlikely that the deviance from Front to Back is being caused by the Middle Leveling Bolts. The following are examples of what could be caused by incorrect pressure on the middle leveling bolts.

**Example 1:** Zero the indicator on the top of the cylinder. When traveling to the bottom of the cylinder, if the reading decreases past  $-.001$ " to something such as  $-.002$ ", then the middle leveling bolts have too little pressure on them and it is bowing the casting slightly in the middle as shown below.

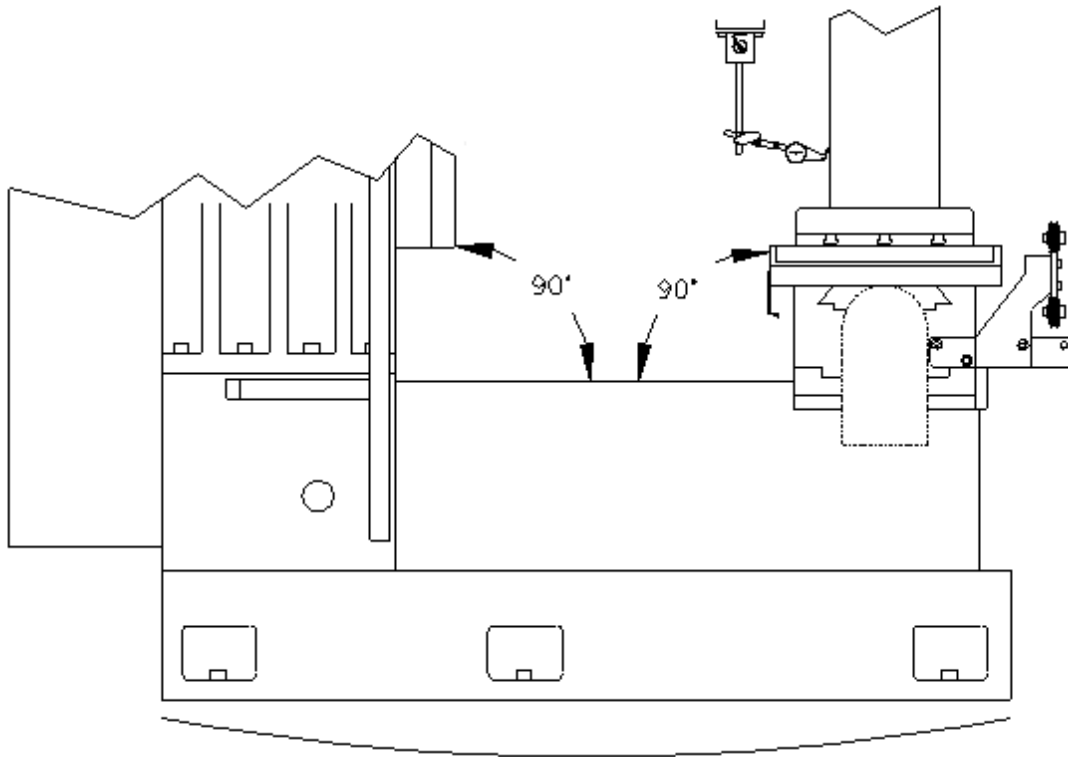

The arched line underneath the picture is illustrating the bow to the casting if the middle leveling bolts have too little pressure on them.

To correct the deviance slowly add pressure to the middle bolts equally. Be sure to watch the level of the machine to be sure not to throw it off. After adding pressure from the middle bolts you can remove pressure from the front and rear corner bolts to bring the deviance within  $.001$ ".

**Example 2:** Zero the indicator on the top of the cylinder. When traveling to the bottom of the cylinder, if the reading decreases past  $+.001''$  to something such as  $+.002''$ , then the middle leveling bolts have too much pressure on them and it is bowing the casting slightly in the middle as shown below.

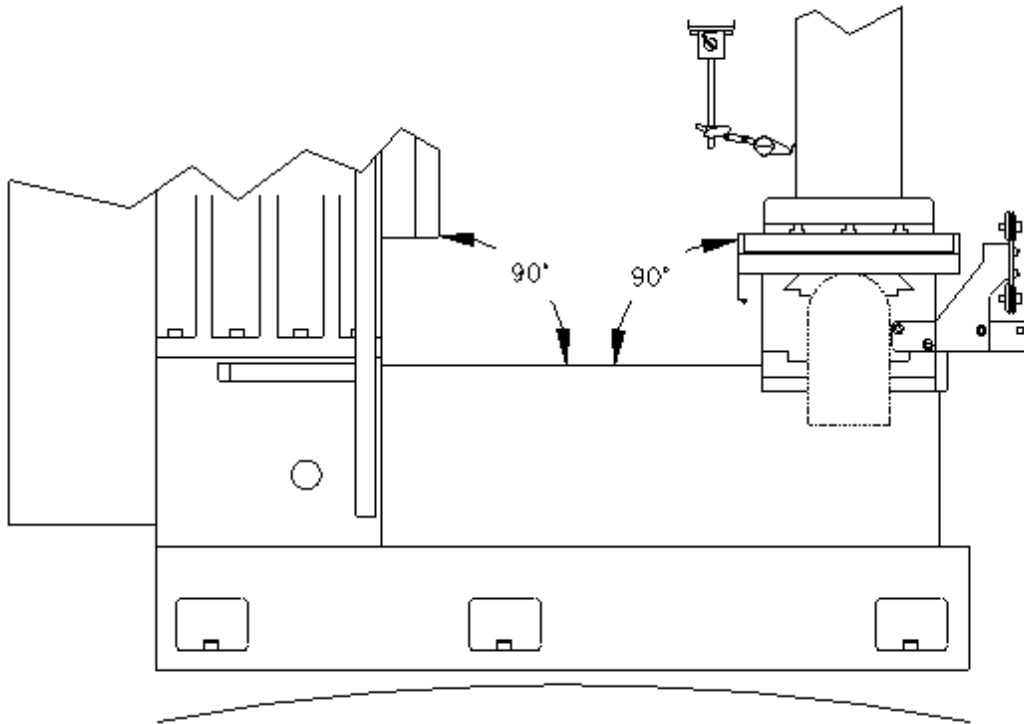

The arched line underneath the picture is illustrating the bow to the casting if the middle leveling bolts have too much pressure on them.

To correct the deviance slowly remove pressure from the middle bolts equally. Be sure to watch the level of the machine to be sure not to throw it off. After relieving pressure from the middle bolts you can apply slightly more pressure to the front corner bolts to bring the deviance within  $.001''$ .

## Vertical Gib Adjustment

Gib adjustments can affect the sweep of the spindle front to back. With the indicator in the 6 O'clock position (as you face the front of the machine) tightening the vertical gibs will lessen the pressure on the indicator probe. Loosening the gib will increase the amount of pressure on the indicator probe.

**Example:** If you have a reading of 0.0 on the indicator at the 6 O'clock position and  $-.002$ " in the 12 O'clock position, tightening the gibs will bring the front of the spindle up. Adjust the gibs until you are within the factory specified  $.001$ " deviance.

To adjust the vertical gibs locate the screw at the top and bottom of the gibs.

### Tightening Gibs

To tighten the gibs, loosen the lower screw. Start tightening the top screw until the correct alignment is achieved. When the correct alignment is achieved, tighten the lower screw to lock the adjustment in place.

**Note:** *Adjusting the gibs too tight will cause sticktion and erratic movement in the vertical travel.*

### Loosening Gibs

To loosen the gibs, loosen the top screw. Start tightening the lower screw until the correct alignment is achieved. When the correct alignment is achieved, tighten the upper screw to lock adjustment in place.

**Note:** *Having the gibs too loose will cause erratic bore size and finish.*

If you do not know how tight or loose the gibs are adjusted, you can remove the way wipers from the top of the gib. When you look in at the gib you will see a horizontal scribe line on most of the gibs. This can be aligned with the internal casting for a starting point. The gibs may need further adjustment at this point. This is only recommended as a starting point.

If there are any questions on this procedure contact Rottler Manufacturing Service Department.

## Replacing the Motherboard Battery

If computer fails to boot up and you get a CMOS error message on the screen, then the battery on the computer motherboard has failed and needs to be replaced.

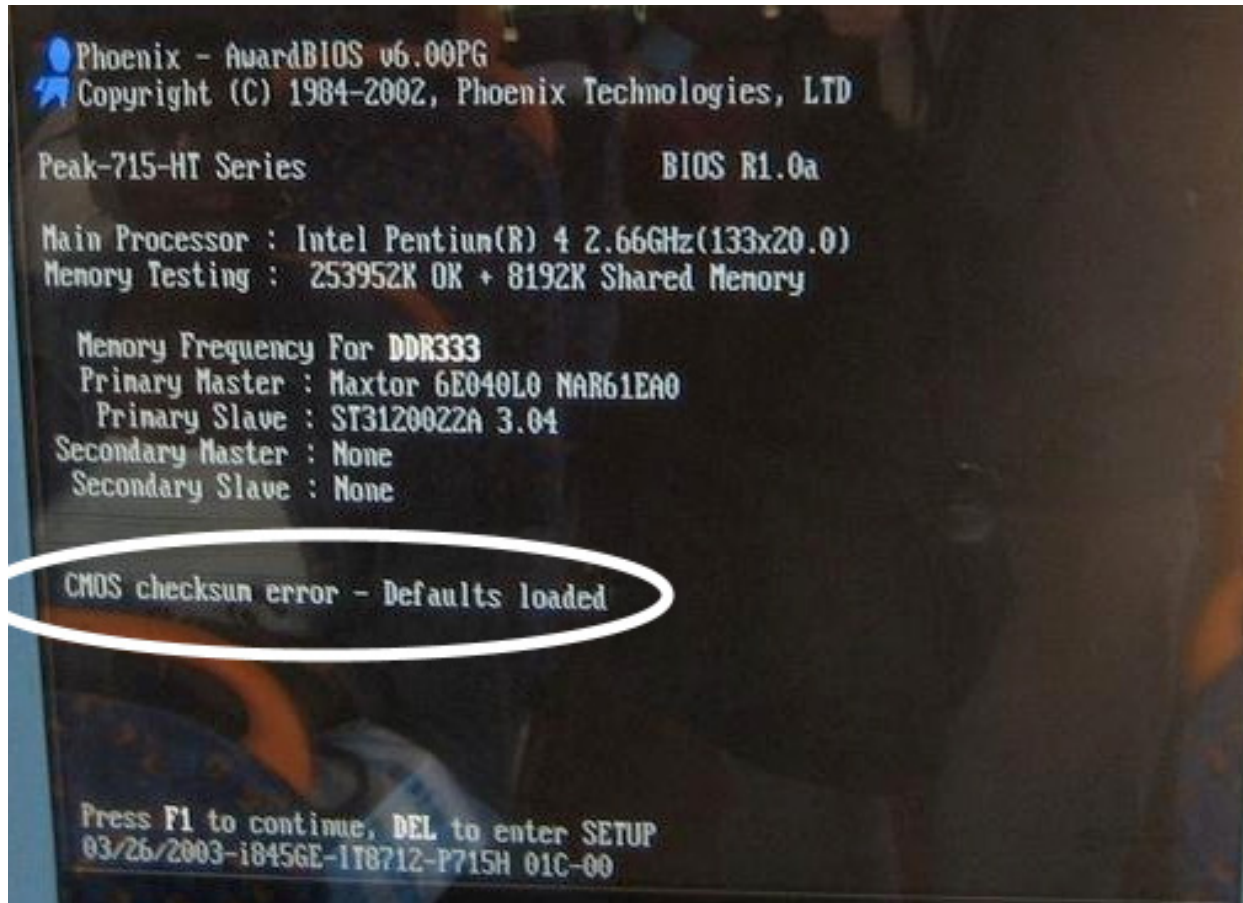

The following is the procedure for replacing the motherboard battery.

Turn off the power on the electrical enclosure and remove the enclosure cover.





Locate the computer and check to see that the power light is not on. If it is on turn off the power switch.  
*Note: On some machines it may be necessary to unbolt the computer from the enclosure in order to gain access to the cover screws.*

Remove the 6 screws indicated by the arrows from the cover.

Remove the cover.



Locate the battery on the motherboard.



Push the battery retention clip away from the battery. When the clip is released the battery will pop up.

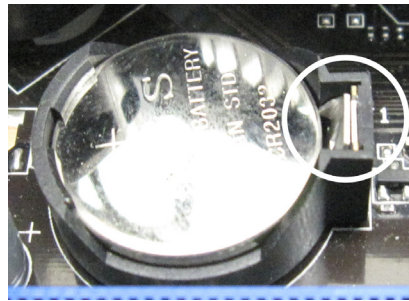

Remove the battery and place new battery in the battery holder.

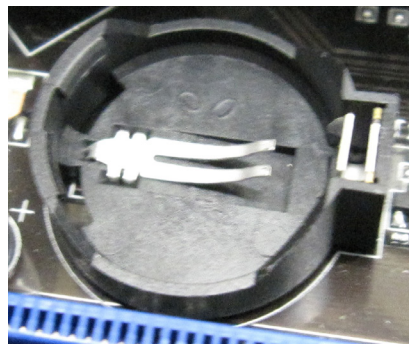

Using your finger tip push down on the battery until the retention clip is in its lock position.



Replace computer cover and make sure that power switch on the computer is on.  
Replace the enclosure cover and switch power back on.

This page intentionally left blank

# TROUBLESHOOTING

**Problem:**

**Icon on screen does not move to area touched.**

**Solution:**

**Follow the procedure below to recalibrate the touchscreen.**

1. Get to the Alignment screen.
  1. If an Elo icon is available in the tool tray at the lower right side of the desktop, click it, then click Align.
  2. Otherwise, go to the Windows Control Panel, double-click Elo Touchscreen and click the Align button on the General tab.
    1. If Windows XP and no Elo icon, click the "Switch to Classic View" button on the left
    2. If Windows 7 and no Elo icon, look for "View by: Category" text toward the upper right; click it and select "Small icons"
2. Touch and release the upper left target; the target should jump to the lower right.
3. Touch and release the lower right target; the target should jump to the upper right.
4. Touch and release the upper right target; a check screen should appear.
5. Touch and release the green check mark; the check screen should disappear.
6. The cursor should now jump to the point of touch.
7. If the Elo Control Panel is open, close it and the Windows Control Panel.

For further assistance in troubleshooting:

Please visit the service tab of our web page at Send a Service Request [www.rottlermfg.com](http://www.rottlermfg.com) or contact the Rottler Factory Service at [service@rottlermfg.com](mailto:service@rottlermfg.com) for assistance and your service request.

You may also call Rottler at 1-800-452-0534 or 1-253-872-7050

Please ensure you have the Machine Model and Serial Number available when contacting Rottler for Service



This page intentionally left blank

# MACHINE PARTS

## Contents

<b>Machine Parts .....</b>	<b>8-1</b>
<b>Electrical Diagram .....</b>	<b>8-1</b>
<b>Pneumatic Diagram .....</b>	<b>8-2</b>
<b>Wire Diagram for Air Solenoid Controls.....</b>	<b>8-3</b>
<b>P69AHD Control Panel .....</b>	<b>8-4</b>
<b>Spindle Unit Assembly Parts.....</b>	<b>8-5</b>
<b>Base .....</b>	<b>8-7</b>
<b>Base Parts List .....</b>	<b>8-8</b>
<b>Column .....</b>	<b>8-9</b>
<b>Column Parts List .....</b>	<b>8-10</b>
<b>Table .....</b>	<b>8-11</b>
<b>Table Parts List.....</b>	<b>8-12</b>
<b>Head Porting Fixture Headstock Assembly Parts .....</b>	<b>8-13</b>
<b>Head Porting Fixture Tailstock Assembly Parts .....</b>	<b>8-15\</b>

# Machine Parts

## Electrical Diagram

Work Light  
Part #  
6457H

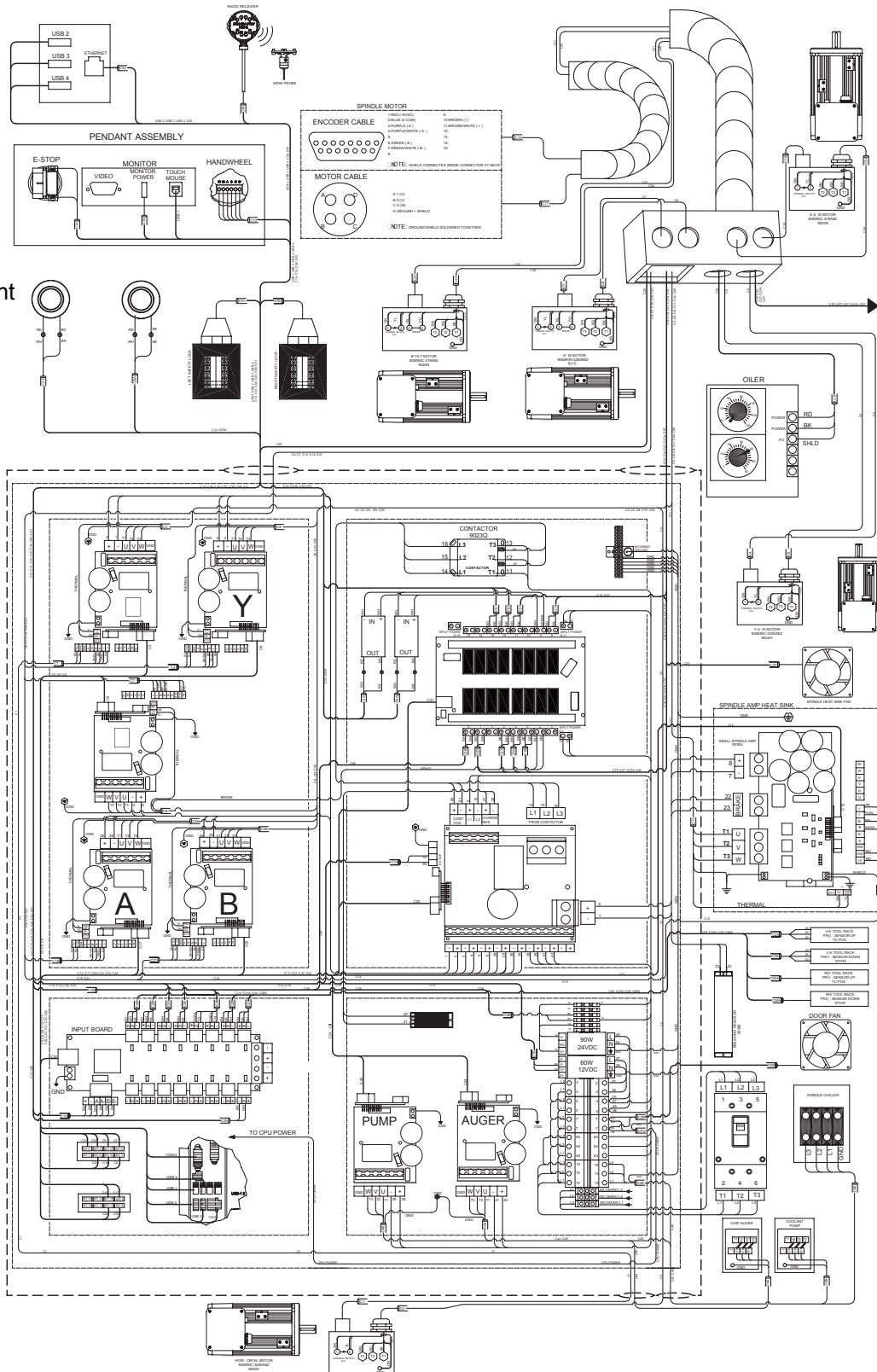



Pneumatic Diagram

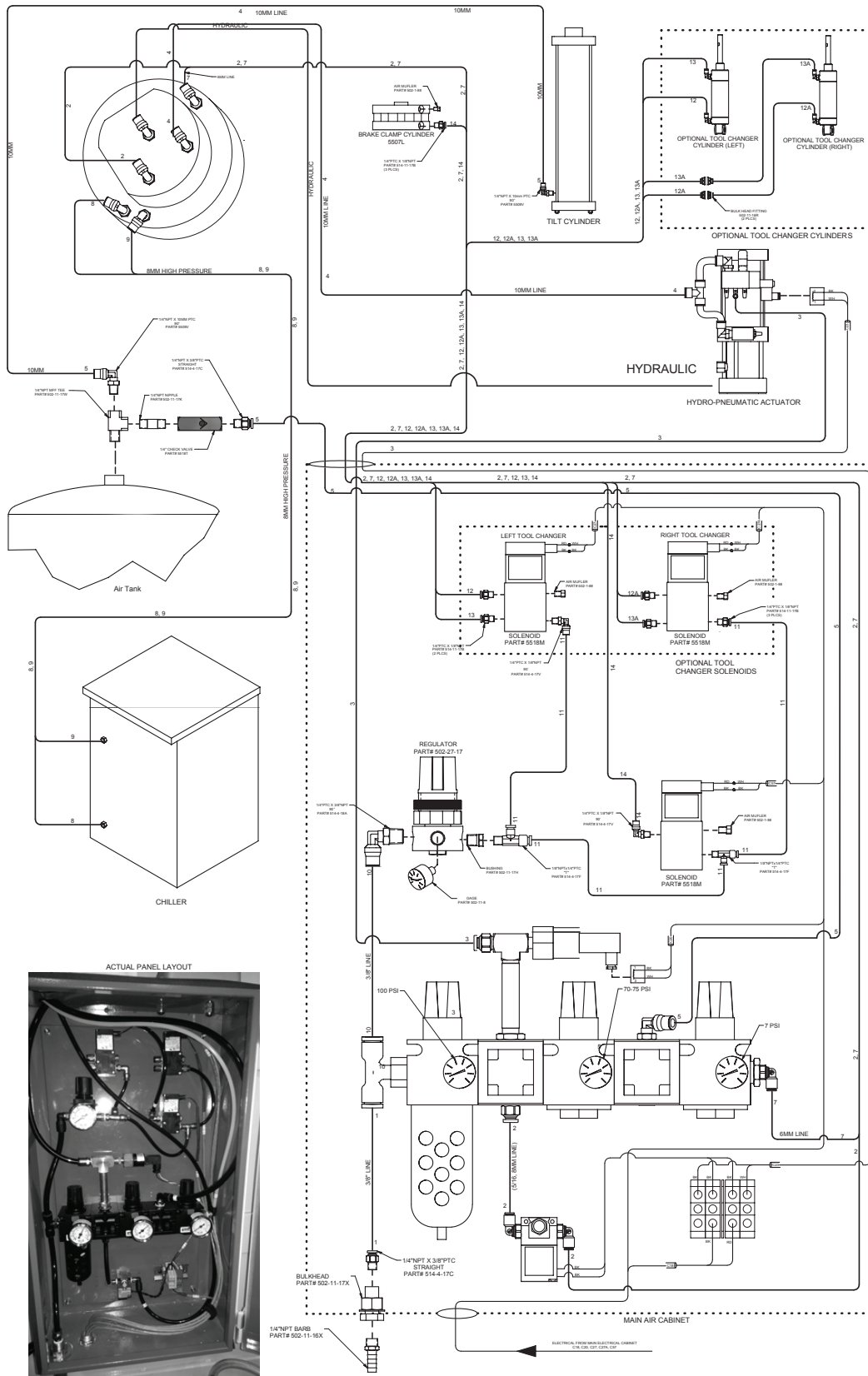

### Wire Diagram for Air Solenoid Controls

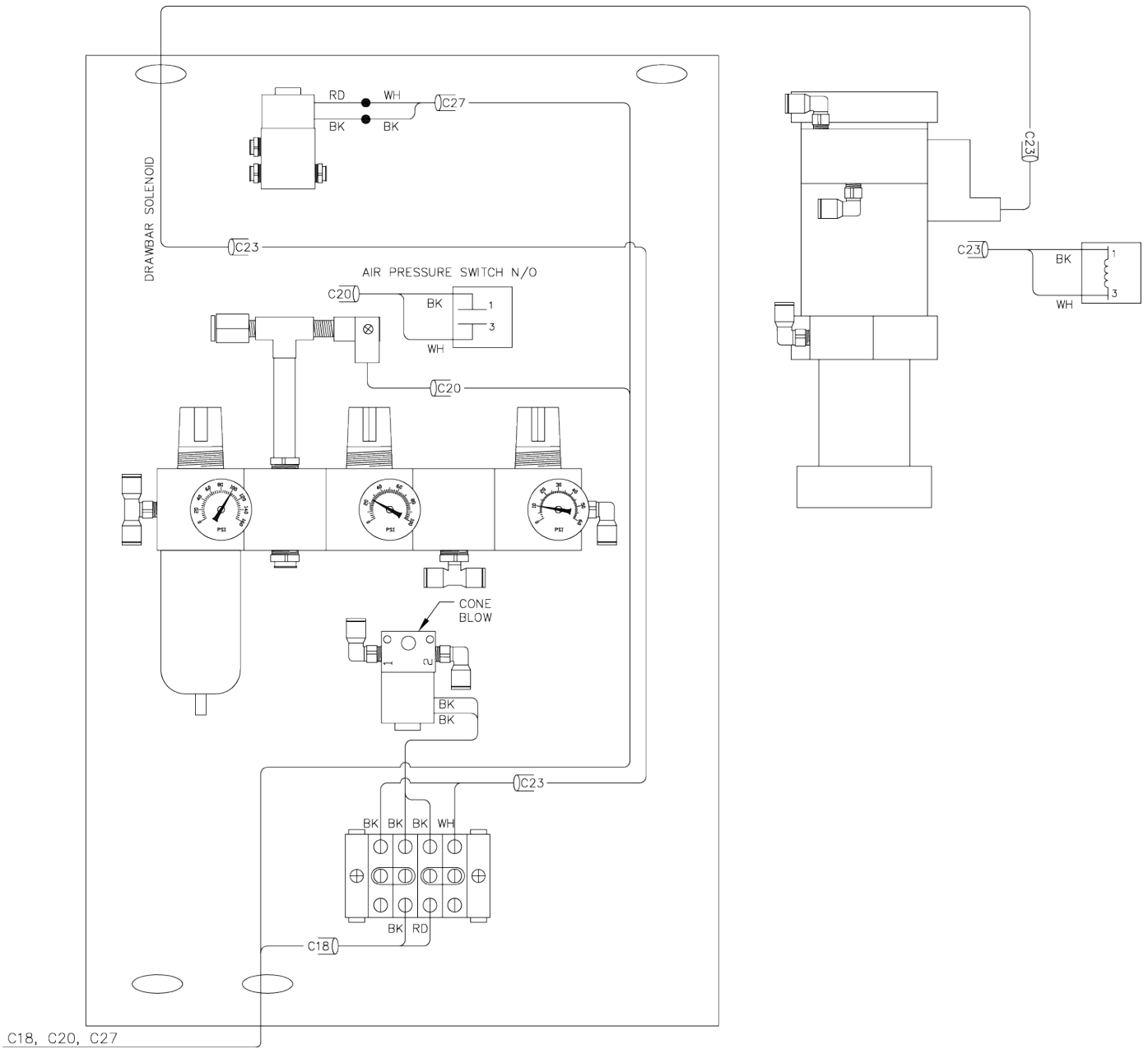

## P69AHD Control Panel

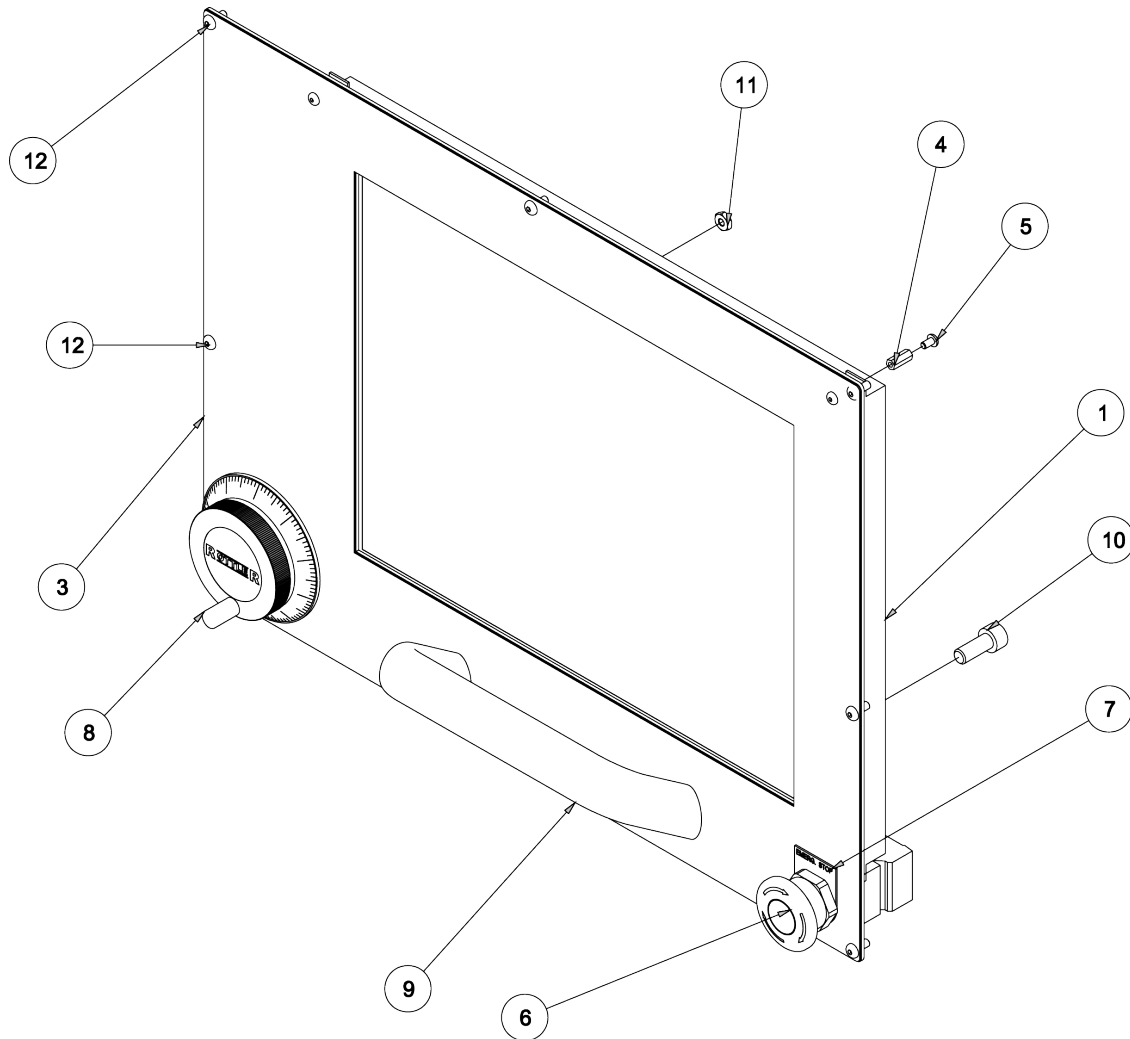

Parts List			
ITEM	QTY	PART NUMBER	DESCRIPTION
1	1	650-1-28X	Touch Screen
2	1	650-1-27V	Face Plate
3	1	650-1-28T	Face Plate Overlay
4	4	7178D	6-32 x .5" Threaded Standoff
5	8	ANSI B18.3 - No. 6-40 - 1/4	Hexagon Socket Button Head Cap Screw
6	1	6389D	E-Stop Button
7	1	6389B	E-Stop Nameplate
8	1	6428	Electronic Handwheel
9	1	650-1-2G	Handle, Pendant
10	2	ANSI B18.3.1M - M8x1.25 x 20	Forged Socket Head Cap Screw x Metric
11	3	ANSI B18.6.3 - 8 - 36	Hex Machine Screw Nut
12	8	ANSI B18.3.4M - M4 x 0.7 x 10	Forged Hexagon Socket Button Head Cap Screw - Metric

### Spindle Unit Assembly Parts

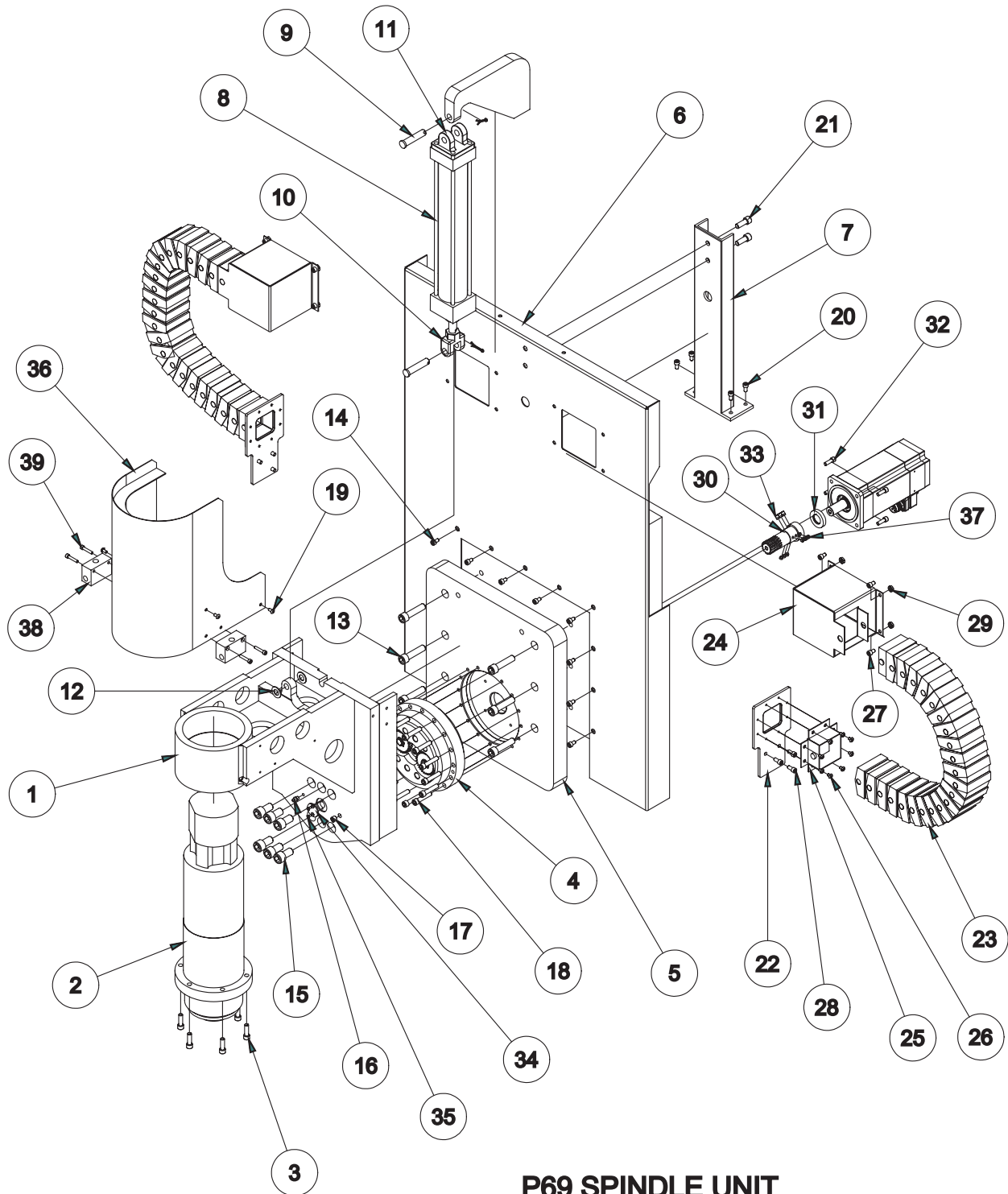

**P69 SPINDLE UNIT  
ASSEMBLY**

P69 SPINDLE UNIT ASSEMBLY			
ITEM	QTY	PART NUMBER	DESCRIPTION
1	1	5506N	MOTOR MOUNT (MACHINING) - P69
2	1	5506M	SPINDLE MOTOR - P69
3	6	MF-23	5/16-18UNC x 1" LONG S.H.C.S.
4	2	5506C	GEARBOX ASSEMBLY
5	2	5507	BASE PLATE (MACHINING), MOTOR MOUNT - P69
6	1	5506H	Z AXIS COVER
7	1	5506J	BRACE, BACK COVER (MACHINING), Z-AXIS - P69
8	1	5508B	COUNTERBALANCE CYLINDER
9	2	5508D	CLEVIS PIN
10	1	5508C	ROD CLEVIS, COUNTERBALANCE CYLINDER - P69
11	1	5508E	PIVOT MOUNT, COUNTERBALANCE CYLINDER - P69
12	2	100-19	Washer
13	6	650-4-47	M12x1.75 x 50mm LG. METRIC S.H.C.S.
14	11	650-4-53	M6x1 x 10mm LG. METRIC S.H.C.S.
15	6	650-4-49	M14x2 x 25mm LG. METRIC S.H.C.S.
16	1	MF-189	STRAIGHT GREASE FITTING
17	1	MF-233	Countersunk Hex-Head Plug 1/8
18	16	MF-25	S.H.C.S. 5/16 - 18 UNC - 1 1/2
19	4	MF-88	10-24UNC x 3/8" LG. Hexagon Socket Button Head Cap Screw
20	4	XXXX	M6x1 x 12mm LG. METRIC S.H.C.S.
21	2	MF-31	3/8-16UNC x 1" LG. S.H.C.S.
22	2	5508K	MOUNT PLATE, IGUS FLEXABLE CONDUIT - SPINDLE MOTOR - P69
23	44	10015	Cable Carrier
24	2	10015G	BOX ASSEMBLY, CABLE CARRIER MOUNT
25	4	9023P	SPINDLE WIRING TRACT BRACKET SET
26	16	MF-87	BUTTON HEAD SCREW 10-24UNC x 5/8" LG.
27	8	MF-11	S.H.C.S. 1/4 - 20 UNC - 3/8
28	6	MF-12	S.H.C.S. 1/4 - 20 UNC - 1/2
29	8	MF-163	1/4-20UNC HEX NUT
30	1	5506D	INPUT GEAR (REWORK) - REDUCTION GEARBOX - P69
31	1	650-3-61N	OIL SEAL
32	4	MF-14	1/4-20UNC x 3/4" LG. S.H.C.S.
33	3	5506G	SET SCREW REWORK 1/4-20
34	1	5506E	COVER, TOOLING HOLE, MOTOR MOUNT - P69
35	2	MF-121A	6-32UNC x 3/8" LG. SOCKET FLAT HEAD SCREW
36	1	5506R	SPINDLE MOTOR COVER - P69 (HI-TORQUE MOTOR)
37	6	5506Q	1/4-20UNC x 3/16" LG. SOCKET FLAT POINT SET SCREW
38	2	5509F	COOLANT MANIFOLD - P69
39	4	MF-6A	S.H.C.S. 10 - 24 UNC - 1
40	1	9020N	BSM80C-375AB2

**Base**

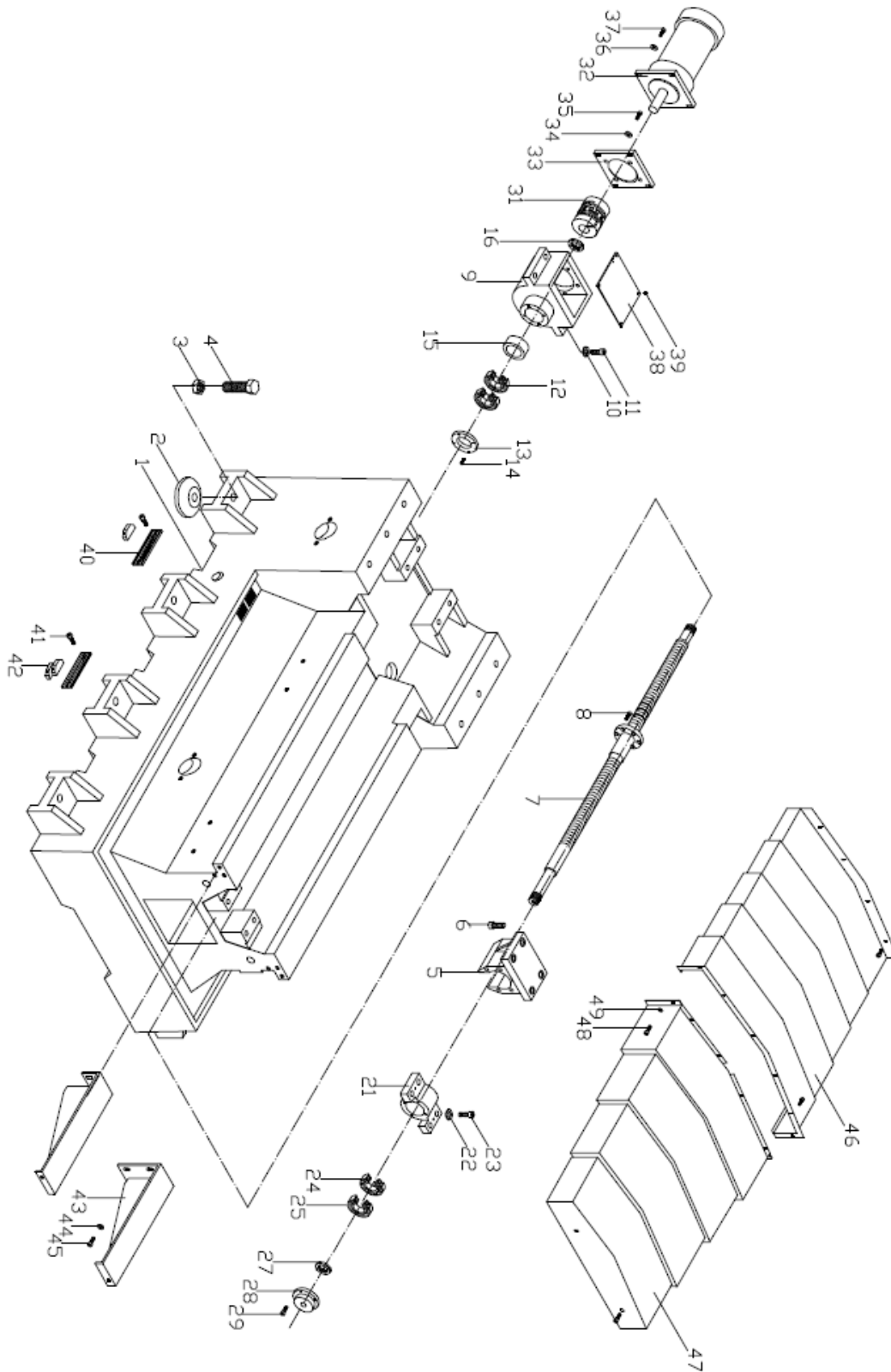

## Base Parts List

ITEM	PART	Description	Q'TY	ITEM	PART	Description	Q'TY
1		Base	1	40		Seat	2
2		Leveling pad	8	41		Screw (M6*12)	4
3		Nut	8	42		Dog	3
4		Screw (M24*70)	8	43		Cover Brace	2
5		Nut Bracket	1	44		Washer (M6)	6
6		Screw(M12*40)	4	45		Screw (M6*20)	6
7	650-6-6A	Ballscrew	1	46		Rear Way Cover	1
8		Screw (M10*25)	5	47		Front Way Cover	1
9		Bearing Bracket	1	48		Screw (M6*12)	18
10		Washer (M12)	4	49		Washer (M6)	18
11		Screw (M12*60)	4				
12		Bearing (25T AC62B)	2				
13		Bearing Cover	1				
14		Screw (M6*20)	4				
15		Spacer	1				
16		Nut (YSF M25*1.5P)	1				
21		Bearing Bracket	1				
22		Washer (M12)	4				
23		Screw (M12*70)	4				
24		Bearing (6305)	1				
25		Bearing (25T AC62B)	1				
27		Nut(YSF M25*1.5P)	1				
28		Cover	1				
29		Screw( M6*12)	4				
31	650-6-6	Coupling	1				
32		Motor	1				
33		Motor Plate	1				
34		Washer (M10)	4				
35		Screw (M10*35)	4				
36		Washer (M10)	4				
37		Screw (M10*35)	4				
38		Cover	1				
39		Screw (M5*8)	4				



Column

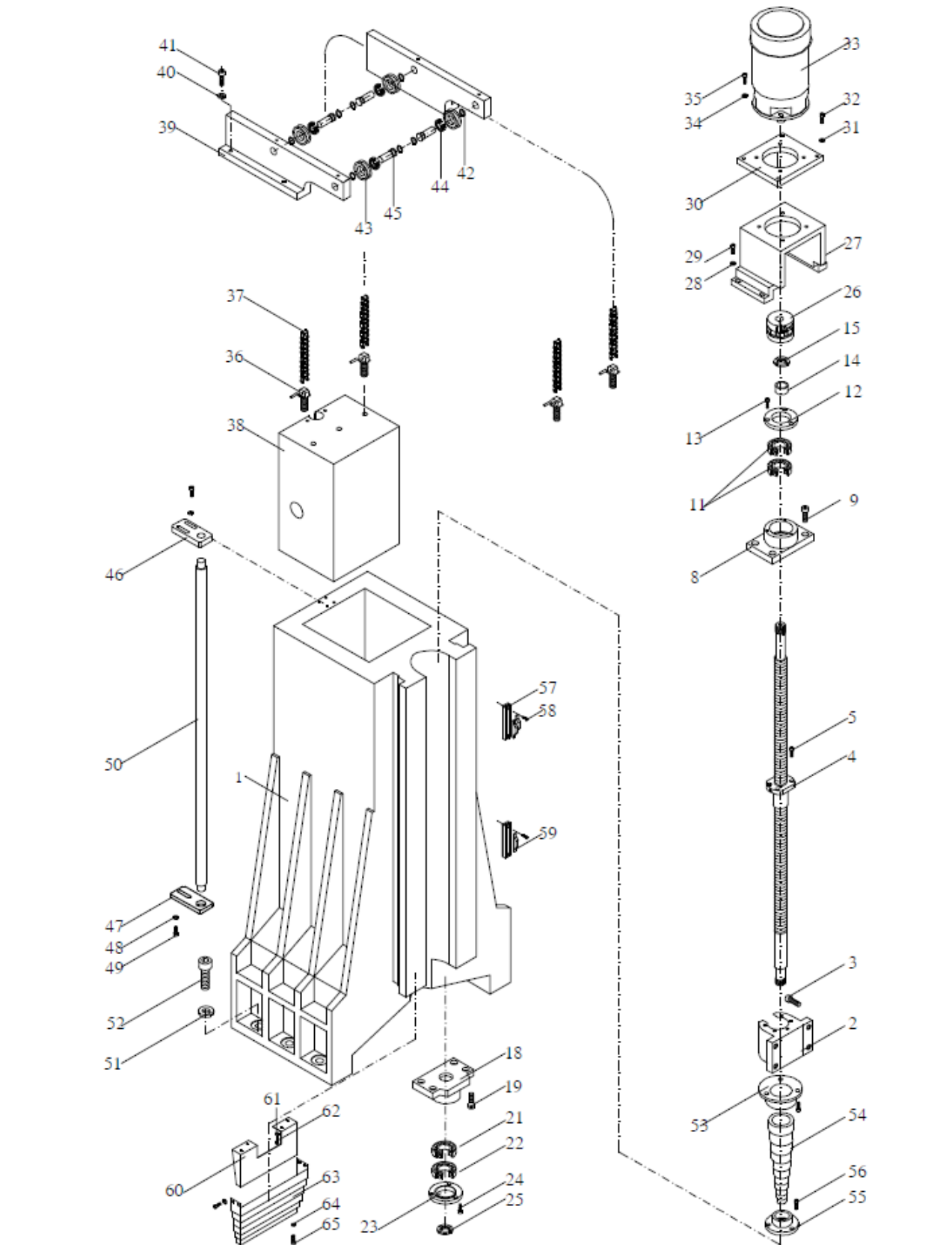

## Column Parts List

ITEM	PART	Description	Q'TY	ITEM	PART	Description	Q'TY
1		Frame	1	39		Chain Supporter	2
2		Nut Bracket	1	40		Washer (M8)	4
3		Screw (M12*40)	4	41		Screw (M8*40)	4
4	650-6-7B	Ballscrew	1	42		C Type Ring	8
5		Screw (M10*25)	5	43		Wheel	4
8		Bracket	1	44		Bearing(6205)	4
9		Screw (M10*35)	4	45		Shaft	4
11		Bearing(7205)	2	46		Guide Pad	1
12		Bracket Cover	1	47		Guide Pad	1
13		Screw (M6*20)	3	48		Washer (M10)	4
14		Space	1	49		Screw (M10*35)	2
15		Nut(M25*1.5P)	1	50		Guide Shaft	1
18		Bracket	1	51		Washer (3/4")	6
19		Screw (M10*30)	4	52		Screw(3/4"*2")	6
21		Bearing(6205)	1	53		Upper Stay	1
22		Bearing(7205)	1	54		Ballscrew Chip Cover	1
23		Cover	1	55		Lower Stay	1
24		Screw (M6*16)	3	56		Screw(M5*8)	5
25		Nut(M25*1.5P)	1	57		Seat	2
26	650-6-7	Coupling	1	58		Screw (M6*12)	4
27		Motor Seat	1	59		Dog	3
28		Washer (M10)	4	60		Cover Brace	1
29		Screw (M10*40)	4	61		Washer (M6)	4
30		Motor Plate	1	62		Screw (M6*16)	4
31		Washer (M10)	4	63		Lower Way Cover	1
32		Screw(M10*35)	4	64		Washer (M6)	6
33		Motor	1	65		Screw (M6*12)	6
34		Washer (M10)	4				
35		Screw(M10*35)	4				
36		Chain Screw(M16)	2				
37		Chain	2				
38		Count Blance	1				

Table

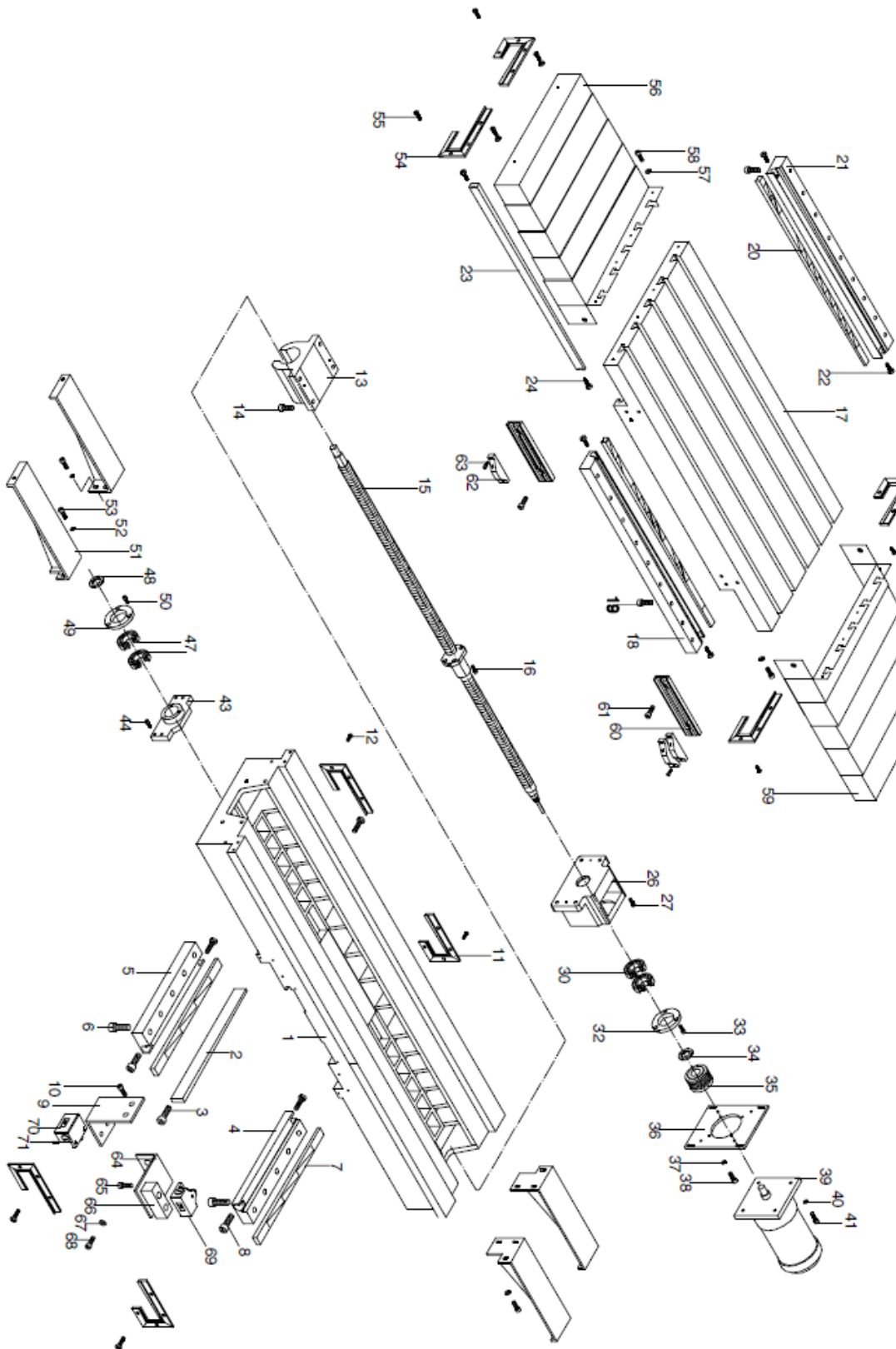

## Table Parts List

ITEM	PART	Description	Q'TY	ITEM	PART	Description	Q'TY
1		Saddle	1	44		Screw (M8*30)	4
2		Gib	1	47		Bearing(6205)	2
3		Gib Screw(5/16**30)	2	48		Nut(YSR M25*1.5P)	1
4		Bracket	1	49		Cover	1
5		Bracket	1	50		Screw (M6*12)	4
6		Screw (M12*40)	10	51		Cover Brace	4
7		Gib	2	52		Washer (M6)	12
8		Gib Screw (5/16**30)	4	53		Screw (M6*20)	12
9		Seat	1	54		Wiper	4
10		Screw (6*16)	2	55		Screw (M5*12)	16
11		Wiper	4	56		Left Way Cover	1
12		Screw(M5*12)	16	57		Washer (M6)	4
13		Nut Bracket	1	58		Screw (M6*12)	12
14		Screw (M12*40)	4	59		Right Way Cover	1
15	650-6-5A	Ball screw	1	60		Seat	2
16		Screw (M10*25)	5	61		Screw(M6*16)	4
17		Table	1	62		Dog	3
18		Bracket	1	63		Screw(M5-12)	6
19		Screw (M12*40)	18	64		Seat	1
20		Gib	2	65		Screw(M6*16)	2
21		Bracket	1	66		Block	1
22		Gib Screw (5/16**30)	4	67		Washer (M6)	2
23		Gib	1	68		Screw (M6*16)	2
24		Gib Screw (5/16**30)	2	69		X Limit Switch	1
26		Bearing Bracket	1	70		Y Limit Switch	1
27		Screw (M10*45)	4	71		Screw(M6*20)	2
30		Bearing(25T AC62)	2				
32		Bearing Cover	1				
33		Screw (M6*20)	3				
34		Nut(YSF M25*1.5P)	1				
35	650-6-5	Coupling	1				
36		Motor Plate	1				
37		Washer (M10)	4				
38		Screw(M10*35)	4				
39		Motor	1				
40		Washer (M10)	4				
41		Screw(M10*35)	4				
43		Bearing Bracket	1				

### Head Porting Fixture Headstock Assembly Parts

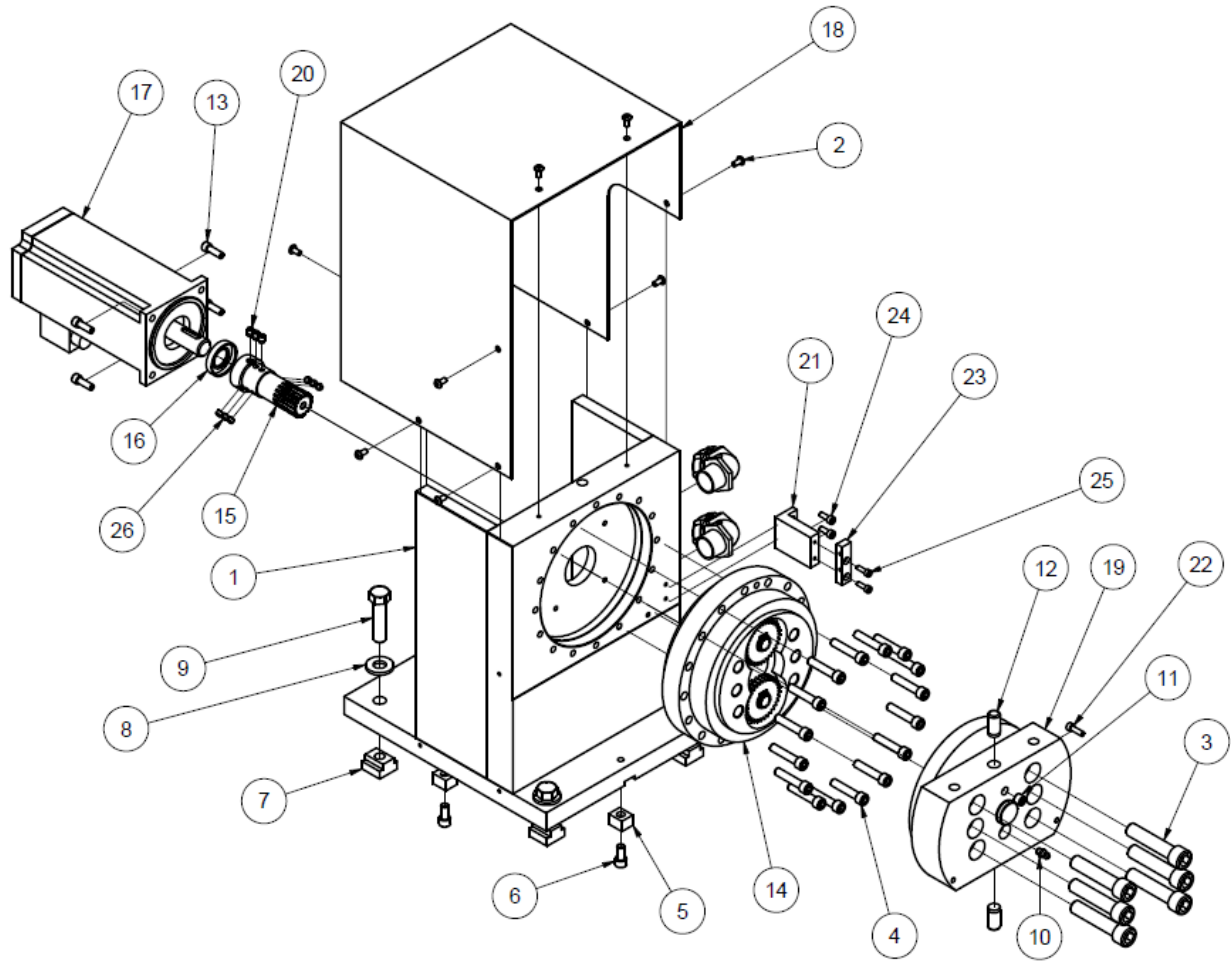

5509 INDEXER HEAD STOCK ASSEMBLY - P69			
ITEM	QTY	PART NUMBER	DESCRIPTION
1	1	5509A	HEAD STOCK (MACHINING) INDEXER P65
2	8	MF-88	BUTTON HEAD SCREW 10-24UNC x 5/8" LG.
3	6	650-4-50	M14x2 x 65mm LG. S.H.C.S.
4	16	MF-25	S.H.C.S. 5/16 - 18 UNC - 1 1/2
5	2	650-3-9	Key
6	2	MF-21	S.H.C.S. 5/16 - 18 UNC - 5/8
7	4	650-3-10	TN-5 T-Nut
8	4	100-19A	Hardened washer 17/32 I.D.
9	4	MF-149C	Hex Bolt 1/2-13 x 2
10	1	MF-189	STRAIGHT GREASE FITTING
11	1	MF-233	1/8-27NPT PIPE PLUG
12	2	MF-213B	1/2 x 1 Dowel Pin
13	4	MF-14	Hexagon Socket Head Cap Screw
14	1	5506C	REDUCTION GEARBOX - P69
15	1	5506D	INPUT GEAR (REWORK) - REDUCTION GEARBOX - P69
16	1	650-3-61N	OIL SEAL
17	1	9020B	SERVO MOTOR
18	1	5509C	COVER, HEAD STOCK, INDEXER - P69
19	1	5509D	MOUNT BLOCK, HEAD STOCK END
20	3	5506G	SET SCREW REWORK 1/4-20
21	1	5509E	MOUNT BLOCK, LIMIT SWITCH - INDEXER HEAD STOCK - P69
22	1	MF-9	S.H.C.S. 10-32 UNF - 0.625
23	1	514-4-61N	Prox Sensor Mount
24	2	MF-5A	S.H.C.S. 10 - 24 UNC - 1/2
25	2	MF-2	S.H.C.S. 8 - 32 UNC - 1/2
26	6	5506Q	1/4-20UNC x 3/16" LG. SOCKET FLAT POINT SET SCREW

### Head Porting Fixture Tailstock Assembly Parts

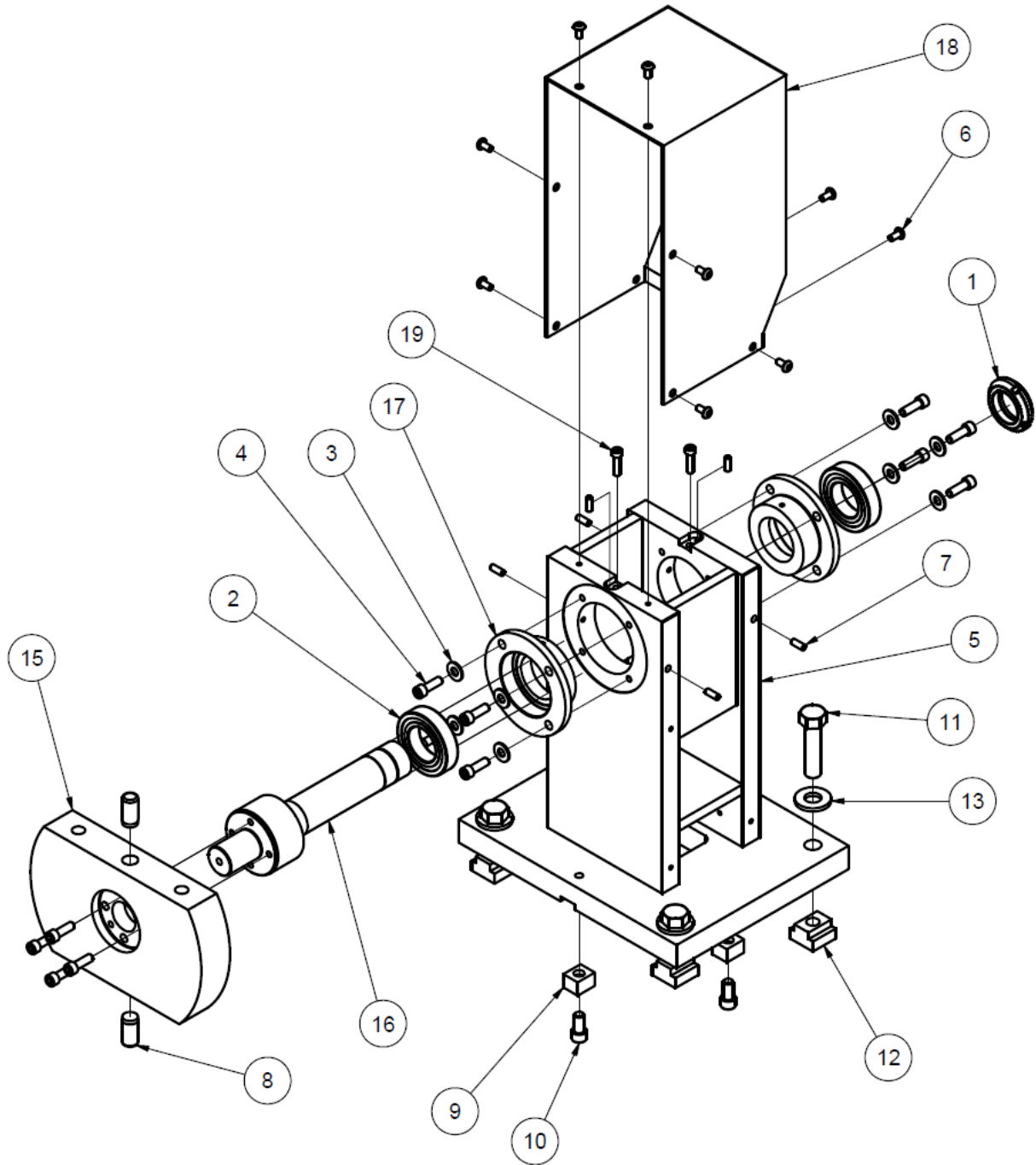



5510 INDEXER TAIL STOCK			
ITEM	QTY	PART NUMBER	DESCRIPTION
1	1	6777B	LOCKNUT BH-06
2	2	502-9-72B	Ball Bearing, MRC/TRW 106KSZZ
3	8	MF-176	SAE FLAT WASHER 1/4"
4	12	MF-14	Hexagon Socket Head Cap Screw
5	1	5510A	TAILSTOCK HOUSING (MACHINING) -
6	10	MF-88	BUTTON HEAD SCREW 10-24UNC x 5/8" LG.
7	6	MF-56B	SOCKET FLAT POINT SET SCREW 10-32UNF x 1/2" LG.
8	2	MF-213B	1/2 x 1 Dowel Pin
9	2	650-3-9	Key
10	2	MF-21	S.H.C.S. 5/16 - 18 UNC - 5/8
11	4	MF-149C	Hex Bolt 1/2-13 x 2
12	4	650-3-10	TN-5 T-Nut
13	4	100-19A	Hardened washer 17/32 I.D.
15	1	5510D	MOUNTING BLOCK, FIXTURE - TAILSTOCK
16	1	5510E	CENTER SHAFT, TAILSTOCK
17	2	5510F	REAR BEARING CUP, TAILSTOCK - P65
18	1	5510C	COVER, TAIL STOCK, INDEXER
19	2	MF-6	Hexagon Socket Head Cap Screw

This page intentionally left blank

# OPTIONS

## Optional Equipment

Optional Equipment Catalog and Parts Manual are located on the Manual CD shipped with machine.

This page intentionally left blank

# MSDS

The Material Data Safety Sheets list shown in this section are the substances and materials that an operator is most likely to come in contact with while using this machine.

Other substances and materials are used in the manufacture, testing, and shipping of this machine. A complete list of the Material Data Safety Sheets of substances and materials used by Rottler Manufacturing during manufacturing, testing, and shipping is located on the Manual CD shipped with the machine. Material Data Safety Sheets are also located on the company web site: <http://www.rottlermfg.com/documentation.php>

- 1) Union 76 CP Oil**
- 2) Dyna Cool K-2002**
- 3) Mobil Vactra Oil #2**
- 4) Valvoline High Performance Gear Oil**
- 5) Valvoline Synpower Synthetic Oil**
- 6) Molywhite #00 Grease**



## CP Oil (All Grades)

### Material Safety Data Sheet

#### 1. PRODUCT AND COMPANY IDENTIFICATION

<b>Product Name:</b>	CP Oil (All Grades)
<b>MSDS Number:</b>	720810
<b>Synonyms:</b>	76 CP Oil 22 76 CP Oil 32
<b>Intended Use:</b>	Industrial Oil
<b>Manufacturer/Supplier:</b>	ConocoPhillips 600 N. Dairy Ashford Houston, Texas 77079-1175
<b>Emergency Health and Safety Number:</b>	Chemtrec: 800-424-9300 (24 Hours)
<b>MSDS Information:</b>	Phone: 800-762-0942 Email: <a href="mailto:MSDS@conocophillips.com">MSDS@conocophillips.com</a> Internet: <a href="http://w3.conocophillips.com/NetMSDS/">http://w3.conocophillips.com/NetMSDS/</a>

#### 2. HAZARDS IDENTIFICATION

##### Emergency Overview

This material is not considered hazardous according to OSHA criteria.

##### NFPA



**Appearance:** Clear and bright  
**Physical Form:** Liquid  
**Odor:** Petroleum

##### Potential Health Effects

**Eye:** Contact may cause mild eye irritation including stinging, watering, and redness.

**Skin:** Contact may cause mild skin irritation including redness and a burning sensation. Prolonged or repeated contact can defat the skin, causing drying and cracking of the skin, and possibly dermatitis (inflammation). No harmful effects from skin absorption are expected.

**Inhalation (Breathing):** No information available on acute toxicity.

**Ingestion (Swallowing):** Low degree of toxicity by ingestion.

**Signs and Symptoms:** Effects of overexposure may include irritation of the digestive tract, nausea and diarrhea. Inhalation of oil mist or vapors at elevated temperatures may cause respiratory irritation.

**Pre-Existing Medical Conditions:** Conditions aggravated by exposure may include skin disorders.

See Section 11 for additional Toxicity Information.

720810 - CP Oil (All Grades)  
Date of Issue: 15-Jul-2008

Page 1/7  
Status: Final

720810 - CP Oil (All Grades)  
Date of Issue: 15-Jul-2008

Page 2/7  
Status: Final

### 3. COMPOSITION / INFORMATION ON INGREDIENTS

Component	CASRN	Concentration*
Lubricant Base Oil (Petroleum)	VARIOUS	>99
Additives	PROPRIETARY	<1

\* All concentrations are percent by weight unless ingredient is a gas. Gas concentrations are in percent by volume.

### 4. FIRST AID MEASURES

**Eye Contact:** If irritation or redness develops from exposure, flush eyes with clean water. If symptoms persist, seek medical attention.

**Skin Contact:** Remove contaminated shoes and clothing and cleanse affected area(s) thoroughly by washing with mild soap and water or a waterless hand cleaner. If irritation or redness develops and persists, seek medical attention.

**Inhalation (Breathing):** If respiratory symptoms develop, move victim away from source of exposure and into fresh air in a position comfortable for breathing. If symptoms persist, seek medical attention.

**Ingestion (Swallowing):** First aid is not normally required; however, if swallowed and symptoms develop, seek medical attention.

**Notes to Physician:** Acute aspirations of large amounts of oil-laden material may produce a serious aspiration pneumonia. Patients who aspirate these oils should be followed for the development of long-term sequelae. Inhalation exposure to oil mists below current workplace exposure limits is unlikely to cause pulmonary abnormalities.

### 5. FIRE-FIGHTING MEASURES

#### NFPA 704 Hazard Class

Health: 0    Flammability: 1    Instability: 0    (0-Minimal, 1-Slight, 2-Moderate, 3-Serious, 4-Severe)

**Unusual Fire & Explosion Hazards:** This material may burn, but will not ignite readily. If container is not properly cooled, it can rupture in the heat of a fire.

**Extinguishing Media:** Dry chemical, carbon dioxide, foam, or water spray is recommended. Water or foam may cause frothing of materials heated above 212°F. Carbon dioxide can displace oxygen. Use caution when applying carbon dioxide in confined spaces.

**Fire Fighting Instructions:** For fires beyond the incipient stage, emergency responders in the immediate hazard area should wear bunker gear. When the potential chemical hazard is unknown, in enclosed or confined spaces, a self contained breathing apparatus should be worn. In addition, wear other appropriate protective equipment as conditions warrant (see Section 8).

Isolate immediate hazard area and keep unauthorized personnel out. Stop spill/release if it can be done safely. Move undamaged containers from immediate hazard area if it can be done safely. Water spray may be useful in minimizing or dispersing vapors and to protect personnel. Cool equipment exposed to fire with water, if it can be done safely. Avoid spreading burning liquid with water used for cooling purposes.

**Hazardous Combustion Products:** Combustion may yield smoke, carbon monoxide, and other products of incomplete combustion. Oxides of sulfur, nitrogen or phosphorus may also be formed.

See Section 9 for Flammable Properties including Flash Point and Flammable (Explosive) Limits

### 6. ACCIDENTAL RELEASE MEASURES

**Personal Precautions:** This material may burn, but will not ignite readily. Keep all sources of ignition away from spill/release. The use of explosion-proof electrical equipment is recommended. Stay upwind and away from spill/release. Notify persons down wind of the spill/release, isolate immediate hazard area and keep unauthorized personnel out. Wear appropriate protective equipment, including respiratory protection, as conditions warrant (see Section 8). See Sections 2 and 7 for additional information on hazards and precautionary measures.



720810 - CP Oil (All Grades)  
Date of Issue: 15-Jul-2008

Page 3/7  
Status: Final

**Environmental Precautions:** Stop spill/release if it can be done safely. Prevent spilled material from entering sewers, storm drains, other unauthorized drainage systems, and natural waterways. Use water sparingly to minimize environmental contamination and reduce disposal requirements. Spills into or upon navigable waters, the contiguous zone, or adjoining shorelines that cause a sheen or discoloration on the surface of the water, may require notification of the National Response Center (phone number 800-424-8802).

**Methods for Containment and Clean-Up:** Notify relevant authorities in accordance with all applicable regulations. Immediate cleanup of any spill is recommended. Dike far ahead of spill for later recovery or disposal. Absorb spill with inert material such as sand or vermiculite, and place in suitable container for disposal.

## 7. HANDLING AND STORAGE

**Precautions for safe handling:** Wash thoroughly after handling. Use good personal hygiene practices and wear appropriate personal protective equipment.

Do not enter confined spaces such as tanks or pits without following proper entry procedures such as ASTM D-4276 and 29CFR 1910.146. Do not wear contaminated clothing or shoes.

"Empty" containers retain residue and may be dangerous. Do not pressurize, cut, weld, braze, solder, drill, grind, or expose such containers to heat, flame, sparks, or other sources of ignition. They may explode and cause injury or death. "Empty" drums should be completely drained, properly bunged, and promptly shipped to the supplier or a drum reconditioner. All containers should be disposed of in an environmentally safe manner and in accordance with governmental regulations. Before working on or in tanks which contain or have contained this material, refer to OSHA regulations, ANSI Z49.1, and other references pertaining to cleaning, repairing, welding, or other contemplated operations.

**Conditions for safe storage:** Keep container(s) tightly closed. Use and store this material in cool, dry, well-ventilated area away from heat and all sources of ignition. Store only in approved containers. Keep away from any incompatible material (see Section 10). Protect container(s) against physical damage.

## 8. EXPOSURE CONTROLS / PERSONAL PROTECTION

Component	US-ACGIH	OSHA	Other
Lubricant Base Oil (Petroleum)	TWA: 5mg/m <sup>3</sup> STEL: 10 mg/m <sup>3</sup> as Oil Mist, if generated	TWA: 5 mg/m <sup>3</sup> as Oil Mist, if generated	---

**Note:** State, local or other agencies or advisory groups may have established more stringent limits. Consult an industrial hygienist or similar professional, or your local agencies, for further information.

**Engineering controls:** If current ventilation practices are not adequate to maintain airborne concentrations below the established exposure limits, additional engineering controls may be required.

**Eye/Face Protection:** The use of eye protection that meets or exceeds ANSI Z.87.1 is recommended to protect against potential eye contact, irritation, or injury. Depending on conditions of use, a face shield may be necessary.

**Skin/Hand Protection:** The use of gloves impervious to the specific material handled is advised to prevent skin contact. Users should check with manufacturers to confirm the breakthrough performance of their products. Suggested protective materials: Nitrile.

**Respiratory Protection:** Where there is potential for airborne exposure above the exposure limit a NIOSH certified air purifying respirator equipped with R or P95 filters may be used.

A respiratory protection program that meets or is equivalent to OSHA 29 CFR 1910.134 and ANSI Z88.2 should be followed whenever workplace conditions warrant a respirator's use. Air purifying respirators provide limited protection and cannot be used in atmospheres that exceed the maximum use concentration (as directed by regulation or the manufacturer's instructions), in oxygen deficient (less than 19.5 percent oxygen) situations, or under conditions that are immediately dangerous to life and health (IDLH).

**Suggestions provided in this section for exposure control and specific types of protective equipment are based on readily available information. Users should consult with the specific manufacturer to confirm the performance of their protective equipment. Specific situations may require consultation with industrial hygiene, safety, or engineering professionals.**

## 9. PHYSICAL AND CHEMICAL PROPERTIES

720810 - CP Oil (All Grades)  
Date of Issue: 15-Jul-2008

Page 4/7  
Status: Final

## 9. PHYSICAL AND CHEMICAL PROPERTIES

**Note:** Unless otherwise stated, values are determined at 20°C (68°F) and 760 mm Hg (1 atm). Data represent typical values and are not intended to be specifications.

Appearance:	Clear and bright
Physical Form:	Liquid
Odor:	Petroleum
Odor Threshold:	No data
pH:	Not applicable
Vapor Pressure:	<1 mm Hg
Vapor Density (air=1):	>1
Boiling Point/Range:	No data
Melting/Freezing Point:	<-11.2°F / <-24°C
Pour Point:	<-11.2°F / <-24°C
Solubility in Water:	Negligible
Partition Coefficient (n-octanol/water) (Kow):	No data
Specific Gravity:	0.86 @ 60°F (15.6°C)
Bulk Density:	7.1 lbs/gal
Viscosity:	4 - 6 cSt @ 100°C; 20 - 35 cSt @ 40°C
Percent Volatile:	Negligible
Evaporation Rate (nBuAc=1):	<1
Flash Point:	>302°F / >150°C
Test Method:	Pensky-Martens Closed Cup (PMCC), ASTM D93, EPA 1010
LEL (vol % in air):	No data
UEL (vol % in air):	No data
Autoignition Temperature:	No data

## 10. STABILITY AND REACTIVITY

**Stability:** Stable under normal ambient and anticipated conditions of storage and handling.

**Conditions to Avoid:** Extended exposure to high temperatures can cause decomposition.

**Materials to Avoid (Incompatible Materials):** Avoid contact with strong oxidizing agents and strong reducing agents.

**Hazardous Decomposition Products:** Not anticipated under normal conditions of use.

**Hazardous Polymerization:** Not known to occur.

## 11. TOXICOLOGICAL INFORMATION

### Chronic Data:

#### Lubricant Base Oil (Petroleum)

**Carcinogenicity:** The petroleum base oils contained in this product have been highly refined by a variety of processes including severe hydrocracking/hydroprocessing to reduce aromatics and improve performance characteristics. All of the oils meet the IP-346 criteria of less than 3 percent PAH's and are not considered carcinogens by NTP, IARC, or OSHA.

### Acute Data:

Component	Oral LD50	Dermal LD50	Inhalation LC50
Lubricant Base Oil (Petroleum)	>5 g/kg	>2 g/kg	No data

## 12. ECOLOGICAL INFORMATION

720810 - CP Oil (All Grades)  
Date of Issue: 15-Jul-2008

Page 5/7  
Status: Final

## 12. ECOLOGICAL INFORMATION

**Ecological Information:** Lubricant oil basestocks are complex mixtures of hydrocarbons (primarily branched chain alkanes and cycloalkanes) ranging in carbon number from C15 to C50. The aromatic hydrocarbon content of these mixtures varies with the severity of the refining process. White oils have negligible levels of aromatic hydrocarbons, whereas significant proportions are found in unrefined basestocks. Olefins are found only at very low concentrations. Volatilization is not significant after release of lubricating oil basestocks to the environment due to the very low vapor pressure of the hydrocarbon constituents. In water, lubricating oil basestocks will float and will spread at a rate that is viscosity dependent. Water solubilities are very low and dispersion occurs mainly from water movement with adsorption by sediment being the major fate process. In soil, lubricating oil basestocks show little mobility and adsorption is the predominant physical process.

Both acute and chronic ecotoxicity studies have been conducted on lubricant base oils. Results indicate that the acute aquatic toxicities to fish, Daphnia, Ceriodaphnia and algal species are above 1000 mg/l using either water accommodated fractions or oil in water dispersions. Since lubricant base oils mainly contain hydrocarbons having carbon numbers in the range C15 to C50, it is predicted that acute toxicity would not be observed with these substances due to low water solubility. Results from chronic toxicity tests show that the no observed effect level (NOEL) usually exceeds 1000 mg/l for lubricant base oils with the overall weight of experimental evidence leading to the conclusion that lubricant base oils do not cause chronic toxicity to fish and invertebrates.

Large volumes spills of lubricant base oils into water will produce a layer of undissolved oil on the water surface that will cause direct physical fouling of organisms and may interfere with surface air exchange resulting in lower levels of dissolved oxygen. Petroleum products have also been associated with causing taint in fish even when the latter are caught in lightly contaminated environments. Highly refined base oils sprayed onto the surface of eggs will result in a failure to hatch.

Extensive experience from laboratory and field trials in a wide range of crops has confirmed that little or no damage is produced as a result of either aerosol exposure or direct application of oil emulsion to the leaves of crop plants. Base oils incorporated into soil have resulted in little or no adverse effects on seed germination and plant growth at contamination rates up to 4%.

## 13. DISPOSAL CONSIDERATIONS

The generator of a waste is always responsible for making proper hazardous waste determinations and needs to consider state and local requirements in addition to federal regulations.

This material, if discarded as produced, would not be a federally regulated RCRA "listed" hazardous waste and is not believed to exhibit characteristics of hazardous waste. See Sections 7 and 8 for information on handling, storage and personal protection and Section 9 for physical/chemical properties. It is possible that the material as produced contains constituents which are not required to be listed in the MSDS but could affect the hazardous waste determination. Additionally, use which results in chemical or physical change of this material could subject it to regulation as a hazardous waste.

This material under most intended uses would become "Used Oil" due to contamination by physical or chemical impurities. Whenever possible, Recycle Used Oil in accordance with applicable federal and state or local regulations. Container contents should be completely used and containers should be emptied prior to discard.

## 14. TRANSPORTATION INFORMATION

### U.S. Department of Transportation (DOT)

Shipping Description:

*Not regulated*

Note:

*If shipped by land in a packaging having a capacity of 3,500 gallons or more, the provisions of 49 CFR, Part 130 apply. (Contains oil)*

### International Maritime Dangerous Goods (IMDG)

Shipping Description:

*Not regulated*

Note:

*U.S. DOT compliance requirements may apply. See 49 CFR 171.22, 23 & 25.*

### International Civil Aviation Org. / International Air Transport Assoc. (ICAO/IATA)

UN/ID #:

*Not regulated*

720810 - CP Oil (All Grades)  
Date of Issue: 15-Jul-2008

Page 6/7  
Status: Final

#### 14. TRANSPORTATION INFORMATION

	LTD. QTY	Passenger Aircraft	Cargo Aircraft Only
Packaging Instruction #:	---	---	---
Max. Net Qty. Per Package:	---	---	---

#### 15. REGULATORY INFORMATION

##### CERCLA/SARA - Section 302 Extremely Hazardous Substances and TPQs (in pounds):

This material does not contain any chemicals subject to the reporting requirements of SARA 302 and 40 CFR 372.

##### CERCLA/SARA - Section 311/312 (Title III Hazard Categories)

Acute Health:	No
Chronic Health:	No
Fire Hazard:	No
Pressure Hazard:	No
Reactive Hazard:	No

##### CERCLA/SARA - Section 313 and 40 CFR 372:

This material does not contain any chemicals subject to the reporting requirements of SARA 313 and 40 CFR 372.

##### EPA (CERCLA) Reportable Quantity (in pounds):

This material does not contain any chemicals with CERCLA Reportable Quantities.

##### California Proposition 65:

This material does not contain any chemicals which are known to the State of California to cause cancer, birth defects or other reproductive harm at concentrations that trigger the warning requirements of California Proposition 65.

##### Canadian Regulations:

This product has been classified in accordance with the hazard criteria of the Controlled Products Regulations (CPR) and the MSDS contains all the information required by the Regulations.

WHMIS Hazard Class  
None

##### National Chemical Inventories:

All components are either listed on the US TSCA Inventory, or are not regulated under TSCA. All components are either on the DSL, or are exempt from DSL listing requirements.

U.S. Export Control Classification Number: EAR99

#### 16. OTHER INFORMATION

Issue Date: 15-Jul-2008  
Status: Final  
Previous Issue Date: 15-Aug-2005  
Revised Sections or Basis for Revision: NFPA ratings (Sections 2&5)  
Physical Properties (Section 9)  
Environmental hazards (Section 12)  
MSDS Number: 720810

##### MSDS Legend:

ACGIH = American Conference of Governmental Industrial Hygienists; ADR = Agreement on Dangerous Goods by Road; CASRN = Chemical Abstracts Service Registry Number; CEILING = Ceiling Limit (15 minutes); EINECS = European Inventory of Existing Commercial Chemical Substances; EPA = [US] Environmental Protection Agency; Germany-TRGS = Technical Rules for Dangerous Substances; IARC = International Agency for Research on Cancer; ICAO/IATA = International Civil Aviation Organization / International Air Transport Association; IMDG = International Maritime Dangerous Goods; Ireland-HSA = Ireland's National Health and Safety Authority; LEL = Lower Explosive Limit; N/A = Not Applicable; N/D = Not Determined; NIOSH = National Institute for Occupational Safety and Health; NTP = [US] National Toxicology Program; OSHA = [US] Occupational Safety and Health Administration; PEL = Permissible Exposure Limit; RID = Regulations Concerning the International Transport of Dangerous Goods by Rail; STEL = Short Term Exposure Limit (15 minutes); TLV = Threshold Limit Value; TWA = Time Weighted Average (8 hours); UEL = Upper Explosive Limit; UK-EH40 = United Kingdom EH40/2005 Workplace Exposure Limits

720810 - CP Oil (All Grades)  
Date of Issue: 15-Jul-2008

Page 7/7  
Status: Final

---

**Disclaimer of Expressed and implied Warranties:**

The information presented in this Material Safety Data Sheet is based on data believed to be accurate as of the date this Material Safety Data Sheet was prepared. HOWEVER, NO WARRANTY OF MERCHANTABILITY, FITNESS FOR ANY PARTICULAR PURPOSE, OR ANY OTHER WARRANTY IS EXPRESSED OR IS TO BE IMPLIED REGARDING THE ACCURACY OR COMPLETENESS OF THE INFORMATION PROVIDED ABOVE, THE RESULTS TO BE OBTAINED FROM THE USE OF THIS INFORMATION OR THE PRODUCT, THE SAFETY OF THIS PRODUCT, OR THE HAZARDS RELATED TO ITS USE. No responsibility is assumed for any damage or injury resulting from abnormal use or from any failure to adhere to recommended practices. The information provided above, and the product, are furnished on the condition that the person receiving them shall make their own determination as to the suitability of the product for their particular purpose and on the condition that they assume the risk of their use. In addition, no authorization is given nor implied to practice any patented invention without a license.

## Material Safety Data Sheet

DYNA COOL K-2002

MSDS No. 5428

Date of Preparation: 6/19/2001

Revision: 8/5/02

### Section 1 - Chemical Product and Company Identification

**Product/Chemical Name:** DYNA COOL K-2002  
**Chemical Formula:** 5428  
**General Use:** CUTTING FLUID  
**Manufacturer:** DYNA TECH CHEMICAL CORPORATION

**P.O. BOX 71**  
**PEWAUKEE, WI 53072**

**PHONE: 262-646-7600**  
**EMERGENCY: 800-535-5053**

<b>HMIS</b>
<b>H</b> 1
<b>F</b> 0
<b>R</b> 0
<b>PPE<sup>X</sup></b>

☆☆☆☆☆ Emergency Overview ☆☆☆☆☆

### Section 2 - Composition / Information on Ingredients

Ingredient Name	CAS Number	% wt or % vol
MINERAL OIL	PROPRIETARY	<20%
TRIETHANOLAMINE	102-71-6	<10%

#### Trace Impurities:

Ingredient	OSHA PEL	ACGIH TLV	NIOSH REL
MINERAL OIL	5 MG/M3 (AS MIST)	5 MG/M3 (AS MIST)	
TRIETHANOLAMINE	5 MG/M3	5 MG/M3	

#### Toxicity Data:

### Section 3 - Physical and Chemical Properties

<b>Physical State:</b> LIQUID	<b>Water Solubility:</b> EMULSIFIES
<b>Appearance and Odor:</b> CLEAR BLUE COLOR, CHARACTERISTIC	<b>Boiling Point:</b> 212 + DEG F
<b>Vapor Pressure:</b> N/A	<b>Vapor Density (Air=1):</b> N/A
<b>Specific Gravity (H<sub>2</sub>O=1, at 4 °C):</b> 1.020	<b>% Volatile:</b> N/A
<b>pH:</b> N/A	<b>Evaporation Rate:</b> N/A

### Section 4 - Fire-Fighting Measures

**Flash Point:** NONE  
**Flash Point Method:** N/A  
**LEL:** NONE  
**UEL:** NONE  
**Flammability Classification:** NONE  
**Extinguishing Media:** WATER FOG, DRY CHEMICAL, FOAM, AND CO<sub>2</sub>  
**Unusual Fire or Explosion Hazards:** NONE KNOWN  
**Fire-Fighting Instructions:** Do not release runoff from fire control methods to sewers or waterways.  
**Fire-Fighting Equipment:** Because fire may produce toxic thermal decomposition products, wear a self-contained breathing apparatus (SCBA) with a full facepiece operated in pressure-demand or positive-pressure mode.



### Section 5 - Stability and Reactivity

**Stability:** DYNA COOL K-2002 is stable at room temperature in closed containers under normal storage and handling conditions.  
**Polymerization:** Hazardous polymerization cannot occur.



MSDS No. 5428

DYNA COOL K-2002

Revision: 8/5/02

**Chemical Incompatibilities:** STRONG OXIDIZING AGENTS  
**Conditions to Avoid:** AVOID CONTACT WITH INCOMPATIBLE MATERIALS AND EXPOSURE TO EXTREME TEMPERATURES  
**Hazardous Decomposition Products:** Thermal oxidative decomposition of DYNA COOL K-2002 can produce OXIDES OF CARBON, TRACES OF FORMALDEHYDE, AMMONIA AND OXIDES OF NITROGEN

### Section 6 - Health Hazard Information

#### Potential Health Effects

**Primary Entry Routes:** INHALATION - SKIN CONTACT - EYE - INGESTION

#### Acute Effects

**Inhalation:** LOW VOLATILITY, IS NOT EXPECTED TO CAUSE IRRITATION WHILE USED UNDER NORMAL CONDITIONS, EXPOSURE TO HIGH MIST LEVELS IN POORLY VENTILATED AREAS MAY IRRITATE THE UPPER RESPIRATORY TRACT WITH SYMPTOMS OF ITCHING EYES AND NASAL PASSAGES.

**Eye:** MILD IRRITATION AND REDNESS MAY RESULT UPON DIRECT CONTACT OR WHEN EXPOSED TO HIGH MIST LEVELS IN POORLY VENTILATED AREAS.

**Skin:** SKIN CONTACT MAY RESULT IN SLIGHT TEMPORARY IRRITATION

**Ingestion:** THIS PRODUCT IS NOT EXPECTED TO CAUSE IRRITATION WHILE USED UNDER NORMAL CONDITIONS.

**Carcinogenicity:** IARC, NTP, and OSHA do not list DYNA COOL K-2002 as a carcinogen.

**Medical Conditions Aggravated by Long-Term Exposure:**

**Chronic Effects:**

#### Emergency and First Aid Procedures

**Inhalation:** REMOVE VICTIM TO FRESH AIR. IF NOT BREATHING, GIVE ARTIFICIAL RESPIRATION, PREFERABLY MOUTH-TO-MOUTH. IF BREATHING IS DIFFICULT, GIVE OXYGEN. CALL A PHYSICIAN.

**Eye Contact:** IMMEDIATELY FLUSH EYE WITH PLENTY OF WATER FOR AT LEAST 15 MINUTES. HOLD EYELIDS OPEN DURING THIS FLUSHING WITH WATER. CALL A PHYSICIAN IMMEDIATELY.

**Skin Contact:** FLUSH AREA WITH WATER WHILE REMOVING CONTAMINATED CLOTHES AND SHOES. FOLLOW BY WASHING WITH SOAP AND WATER. DO NOT REUSE CLOTHING OR SHOES UNTIL CLEANED. IF IRRITATION PERSISTS, GET MEDICAL ATTENTION. DO NOT APPLY OILS OR OINTMENTS, UNLESS ORDERED BY PHYSICIAN.

**Ingestion:** IF CONSCIOUS, DRINK A QUART OF WATER. DO NOT INDUCE VOMITING. CALL A PHYSICIAN IMMEDIATELY. IF UNCONSCIOUS OR IF IN CONVULSIONS, TAKE IMMEDIATELY TO A HOSPITAL OR PHYSICIAN. NEVER INDUCE VOMITING OR GIVE ANYTHING BY MOUTH TO AN UNCONSCIOUS VICTIM. AFTER DILUTION WITH WATER, FRUIT JUICE MAY BE ADMINSTRATED TO ACCOMPLISH NEUTRALIZATION. SEVERAL GLASSES OF MILK OR SEVERAL OUNCES MILK OF MAGNESIA MAY BE GIVEN FOR THEIR SOOTHING EFFECT. GET MEDICAL ATTENTION.

*After first aid, get appropriate in-plant, paramedic, or community medical support.*

**Note to Physicians:** NONE

**Special Precautions/Procedures:** NONE

### Section 7 - Spill, Leak, and Disposal Procedures

**Spill /Leak Procedures:** EVACUATE UNPROTECTED PERSONNEL FROM AREA. MAINTAIN ADEQUATE VENTILATION. USE PROPER SAFETY EQUIPMENT. SWEEP UP MATERIAL INTO CONTAINERS AND DISPOSE OF PROPERLY. AVOID DIRECT DISCHARGE TO SEWERS AND SURFACE WATERS. NOTIFY AUTHORITIES IF ENTRY OCCURS.

#### Spills

**Containment:** For large spills, dike far ahead of liquid spill for later disposal. Do not release into sewers or waterways.

**Regulatory Requirements:** Follow applicable OSHA regulations (29 CFR 1910.120).

**Disposal:** Contact your supplier or a licensed contractor for detailed recommendations. Follow applicable Federal, state, and local regulations.

**Disposal Regulatory Requirements:** OBSERVE ALL LOCAL, STATE, AND FEDERAL REGULATIONS.

**Container Cleaning and Disposal:** OBSERVE ALL LOCAL, STATE, AND FEDERAL REGULATIONS. DISPOSE OF AT APPROVED WASTE TREATMENT FACILITY. IF APPROVED NEUTRALIZE MATERIAL AND FLUSH TO SEWER. DO NOT PRESSURIZE, CUT, WELD, BRAZE, SOIDER, DRILL, GRIND, OR EXPOSE EMPTY CONTAINERS TO HEAT, FLAME, SPARKS OR OTHER SOURCES OF IGNITION.

**Ecological Information:**

**EPA Regulations:**



Revision: 8/5/02

DYNA COOL K-2002

MSDS No. 5428

This information may be subject to the provision reporting requirements of Section 313 of the Superfund Amendment and Reauthorization Act of 1986 (SARA). All sections - CERCLA, RCRA, and OSHA.

### Section 8 - Exposure Controls / Personal Protection

**Engineering Controls:**

**Ventilation:** Provide general or local exhaust ventilation systems to maintain airborne concentrations below OSHA PELs (Sec. 2). Local exhaust ventilation is preferred because it prevents contaminant dispersion into the work area by controlling it at its source.

**Administrative Controls:**

**Respiratory Protection:** Seek professional advice prior to respirator selection and use. Follow OSHA respirator regulations (29 CFR 1910.134) and, if necessary, wear a MSHA/NIOSH-approved respirator. Select respirator based on its suitability to provide adequate worker protection for given working conditions, level of airborne contamination, and presence of sufficient oxygen. For emergency or non routine operations (cleaning spills, reactor vessels, or storage tanks), wear an SCBA.

*Warning! Air-purifying respirators do not protect workers in oxygen-deficient atmospheres.* If respirators are used, OSHA requires a written respiratory protection program that includes at least: medical certification, training, fit-testing, periodic environmental monitoring, maintenance, inspection, cleaning, and convenient, sanitary storage areas.

**Protective Clothing/Equipment:** Wear chemically protective gloves, boots, aprons, and gauntlets to prevent prolonged or repeated skin contact. Wear protective eyeglasses or chemical safety goggles, per OSHA eye- and face-protection regulations (29 CFR 1910.133). Contact lenses are not eye protective devices. Appropriate eye protection must be worn instead of, or in conjunction with contact lenses.

**Safety Stations:** Make emergency eyewash stations, safety/quick-drench showers, and washing facilities available in work area.

**Contaminated Equipment:** Separate contaminated work clothes from street clothes. Launder before reuse. Remove this material from your shoes and clean personal protective equipment.

**Comments:** Never eat, drink, or smoke in work areas. Practice good personal hygiene after using this material, especially before eating, drinking, smoking, using the toilet, or applying cosmetics.

### Section 9 - Special Precautions and Comments

**Handling Precautions:** WEAR CHEMICAL SAFETY GOGGLES OR FACE SHIELD WITH SAFETY GOGGLES, AND PROTECTIVE CLOTHING. USE SELF-CONTAINED BREATHING APPARATUS IF NECESSARY. DO NOT USE IN POORLY VENTILATED OR CONFINED SPACES. WHEN MAKING SOLUTIONS, HEAT MAY BE GENERATED. ADD SLOWLY TO SURFACES OF SOLUTION WHILE STIRRING TO AVOID SPLATTERING. NEVER USE PRESSURE TO EMPTY CONTAINERS. EMPTY CONTAINERS MAY CONTAIN EXPLOSIVE VAPORS OR DANGEROUS RESIDUES. DO NOT CUT, PUNCTURE, OR WELD ON OR NEAR CONTAINER. ALL LABELLED HAZARDOUS PRECAUTIONS MUST BE OBSERVED. DO NOT REUSE EMPTY CONTAINER WITHOUT COMMERCIAL CLEANING OR RECONDITIONING.

**Storage Requirements:** STORE IN COOL, WELL-VENTILATED AREA AWAY FROM HEAT AND OUT OF DIRECT SUNLIGHT. DO NOT STORE OPEN, UNLABELLED, MISLABELLED, OR EMPTY CONTAINERS. KEEP CONTAINERS TIGHTLY CLOSED. STORE AWAY FROM INCOMPATIBLE MATERIALS. DO NOT EAT, DRINK, OR SMOKE IN WORK AREA.

#### DOT Transportation Data (49 CFR 172.101):

**Shipping Name:** NOT DOT HAZARDOUS AS PACKAGED

**Hazard Class:** NONE

**Packing Group:** III

**Label:** NONE

**Prepared By:** SLW

**Revision Notes:**

**Disclaimer:** THE DATA IN THIS MATERIAL SAFETY DATA SHEET IS BELIEVED TO BE CORRECT. HOWEVER, SINCE CONDITIONS OF USE ARE OUTSIDE OUR CONTROL IT SHOULD NOT BE TAKEN AS A WARRANTY OR REPRESENTATION FOR WHICH WE ASSUME LEGAL RESPONSIBILITY. THIS INFORMATION IS PROVIDED SOLELY FOR YOUR CONSIDERATION, INVESTIGATION, AND VERIFICATION.



Product Name: MOBIL VACTRA OIL NO. 2  
 Revision Date: 17Oct2008  
 Page 1 of 8

## MATERIAL SAFETY DATA SHEET

### SECTION 1 PRODUCT AND COMPANY IDENTIFICATION

#### PRODUCT

**Product Name:** MOBIL VACTRA OIL NO. 2  
**Product Description:** Base Oil and Additives  
**Product Code:** 600494-00, 970716  
**Intended Use:** Lubricant

#### COMPANY IDENTIFICATION

**Supplier:** EXXON MOBIL CORPORATION  
 3225 GALLOWS RD.  
 FAIRFAX, VA. 22037 USA

**24 Hour Health Emergency:** 609-737-4411  
**Transportation Emergency Phone:** 800-424-9300  
**ExxonMobil Transportation No.:** 281-834-3296  
**Product Technical Information:** 800-662-4525, 800-947-9147  
**MSDS Internet Address:** <http://www.exxon.com>, <http://www.mobil.com>

### SECTION 2 COMPOSITION / INFORMATION ON INGREDIENTS

No Reportable Hazardous Substance(s) or Complex Substance(s).

### SECTION 3 HAZARDS IDENTIFICATION

This material is not considered to be hazardous according to regulatory guidelines (see (M)SDS Section 15).

#### POTENTIAL HEALTH EFFECTS

Low order of toxicity. Excessive exposure may result in eye, skin, or respiratory irritation. High-pressure injection under skin may cause serious damage.

**NFPA Hazard ID:** Health: 0 Flammability: 1 Reactivity: 0  
**HMIS Hazard ID:** Health: 0 Flammability: 1 Reactivity: 0

**NOTE:** This material should not be used for any other purpose than the intended use in Section 1 without expert advice. Health studies have shown that chemical exposure may cause potential human health risks which may vary from person to person.

### SECTION 4 FIRST AID MEASURES

#### INHALATION

Remove from further exposure. For those providing assistance, avoid exposure to yourself or others. Use adequate respiratory protection. If respiratory irritation, dizziness, nausea, or unconsciousness occurs, seek immediate medical assistance. If breathing has stopped, assist ventilation with a mechanical device or use



Product Name: MOBIL VACTRA OIL NO. 2  
Revision Date: 17Oct2008  
Page 2 of 8

mouth-to-mouth resuscitation.

#### SKIN CONTACT

Wash contact areas with soap and water. If product is injected into or under the skin, or into any part of the body, regardless of the appearance of the wound or its size, the individual should be evaluated immediately by a physician as a surgical emergency. Even though initial symptoms from high pressure injection may be minimal or absent, early surgical treatment within the first few hours may significantly reduce the ultimate extent of injury.

#### EYE CONTACT

Flush thoroughly with water. If irritation occurs, get medical assistance.

#### INGESTION

First aid is normally not required. Seek medical attention if discomfort occurs.

### SECTION 5 FIRE FIGHTING MEASURES

#### EXTINGUISHING MEDIA

**Appropriate Extinguishing Media:** Use water fog, foam, dry chemical or carbon dioxide (CO<sub>2</sub>) to extinguish flames.

**Inappropriate Extinguishing Media:** Straight Streams of Water

#### FIRE FIGHTING

**Fire Fighting Instructions:** Evacuate area. Prevent runoff from fire control or dilution from entering streams, sewers, or drinking water supply. Firefighters should use standard protective equipment and in enclosed spaces, self-contained breathing apparatus (SCBA). Use water spray to cool fire exposed surfaces and to protect personnel.

**Hazardous Combustion Products:** Smoke, Fume, Aldehydes, Sulfur oxides, Incomplete combustion products, Oxides of carbon

#### FLAMMABILITY PROPERTIES

**Flash Point [Method]:** >205C (401F) [ASTM D-92]

**Flammable Limits (Approximate volume % in air):** LEL: 0.9 UEL: 7.0

**Autoignition Temperature:** N/D

### SECTION 6 ACCIDENTAL RELEASE MEASURES

#### NOTIFICATION PROCEDURES

In the event of a spill or accidental release, notify relevant authorities in accordance with all applicable regulations. US regulations require reporting releases of this material to the environment which exceed the applicable reportable quantity or oil spills which could reach any waterway including intermittent dry creeks. The National Response Center can be reached at (800)424-8802.

#### SPILL MANAGEMENT



Product Name: MOBIL VACTRA OIL NO. 2  
Revision Date: 17Oct2008  
Page 3 of 8

**Land Spill:** Stop leak if you can do it without risk. Recover by pumping or with suitable absorbent.

**Water Spill:** Stop leak if you can do it without risk. Confine the spill immediately with booms. Warn other shipping. Remove from the surface by skimming or with suitable absorbents. Seek the advice of a specialist before using dispersants.

Water spill and land spill recommendations are based on the most likely spill scenario for this material; however, geographic conditions, wind, temperature, (and in the case of a water spill) wave and current direction and speed may greatly influence the appropriate action to be taken. For this reason, local experts should be consulted. Note: Local regulations may prescribe or limit action to be taken.

#### ENVIRONMENTAL PRECAUTIONS

Large Spills: Dike far ahead of liquid spill for later recovery and disposal. Prevent entry into waterways, sewers, basements or confined areas.

### SECTION 7 HANDLING AND STORAGE

#### HANDLING

Prevent small spills and leakage to avoid slip hazard.

**Static Accumulator:** This material is a static accumulator.

#### STORAGE

Do not store in open or unlabelled containers. Keep away from incompatible materials.

### SECTION 8 EXPOSURE CONTROLS / PERSONAL PROTECTION

**Exposure limits/standards for materials that can be formed when handling this product:** When mists / aerosols can occur, the following are recommended: 5 mg/m<sup>3</sup> - ACGIH TLV, 10 mg/m<sup>3</sup> - ACGIH STEL, 5 mg/m<sup>3</sup> - OSHA PEL.

NOTE: Limits/standards shown for guidance only. Follow applicable regulations.

#### ENGINEERING CONTROLS

The level of protection and types of controls necessary will vary depending upon potential exposure conditions. Control measures to consider:  
No special requirements under ordinary conditions of use and with adequate ventilation.

#### PERSONAL PROTECTION

Personal protective equipment selections vary based on potential exposure conditions such as applications, handling practices, concentration and ventilation. Information on the selection of protective equipment for use with this material, as provided below, is based upon intended, normal usage.

**Respiratory Protection:** If engineering controls do not maintain airborne contaminant concentrations at a level which is adequate to protect worker health, an approved respirator may be appropriate. Respirator



Product Name: MOBIL VACTRA OIL NO. 2  
Revision Date: 17 Oct 2008  
Page 4 of 8

selection, use, and maintenance must be in accordance with regulatory requirements, if applicable. Types of respirators to be considered for this material include:

No special requirements under ordinary conditions of use and with adequate ventilation.

For high airborne concentrations, use an approved supplied-air respirator, operated in positive pressure mode. Supplied air respirators with an escape bottle may be appropriate when oxygen levels are inadequate, gas/vapor warning properties are poor, or if air purifying filter capacity/rating may be exceeded.

**Hand Protection:** Any specific glove information provided is based on published literature and glove manufacturer data. Glove suitability and breakthrough time will differ depending on the specific use conditions. Contact the glove manufacturer for specific advice on glove selection and breakthrough times for your use conditions. Inspect and replace worn or damaged gloves. The types of gloves to be considered for this material include:

No protection is ordinarily required under normal conditions of use.

**Eye Protection:** If contact is likely, safety glasses with side shields are recommended.

**Skin and Body Protection:** Any specific clothing information provided is based on published literature or manufacturer data. The types of clothing to be considered for this material include:

No skin protection is ordinarily required under normal conditions of use. In accordance with good industrial hygiene practices, precautions should be taken to avoid skin contact.

**Specific Hygiene Measures:** Always observe good personal hygiene measures, such as washing after handling the material and before eating, drinking, and/or smoking. Routinely wash work clothing and protective equipment to remove contaminants. Discard contaminated clothing and footwear that cannot be cleaned. Practice good housekeeping.

#### ENVIRONMENTAL CONTROLS

See Sections 6, 7, 12, 13.

#### SECTION 9

#### PHYSICAL AND CHEMICAL PROPERTIES

Typical physical and chemical properties are given below. Consult the Supplier in Section 1 for additional data.

#### GENERAL INFORMATION

**Physical State:** Liquid  
**Color:** Brown  
**Odor:** Characteristic  
**Odor Threshold:** N/D

#### IMPORTANT HEALTH, SAFETY, AND ENVIRONMENTAL INFORMATION

**Relative Density (at 15 C):** 0.883  
**Flash Point [Method]:** >205C (401F) [ASTM D-92]  
**Flammable Limits (Approximate volume % in air):** LEL: 0.9 UEL: 7.0  
**Autoignition Temperature:** N/D  
**Boiling Point / Range:** N/D  
**Vapor Density (Air = 1):** > 2 at 101 kPa  
**Vapor Pressure:** <0.013 kPa (0.1 mm Hg) at 20 C  
**Evaporation Rate (n-butyl acetate = 1):** N/D  
**pH:** N/A



Product Name: MOBIL VACTRA OIL NO. 2  
 Revision Date: 17Oct2008  
 Page 5 of 8

**Log Pow (n-Octanol/Water Partition Coefficient):** > 3.5  
**Solubility in Water:** Negligible  
**Viscosity:** 68 cSt (68 mm<sup>2</sup>/sec) at 40 C | 8.6 cSt (8.6 mm<sup>2</sup>/sec) at 100C  
**Oxidizing Properties:** See Sections 3, 15, 16.

#### OTHER INFORMATION

**Freezing Point:** ND  
**Melting Point:** N/A  
**Pour Point:** -6°C (21°F)  
**DMSO Extract (mineral oil only), IP-346:** < 3 %wt

#### SECTION 10 STABILITY AND REACTIVITY

**STABILITY:** Material is stable under normal conditions.

**CONDITIONS TO AVOID:** Excessive heat. High energy sources of ignition.

**MATERIALS TO AVOID:** Strong oxidizers

**HAZARDOUS DECOMPOSITION PRODUCTS:** Material does not decompose at ambient temperatures.

**HAZARDOUS POLYMERIZATION:** Will not occur.

#### SECTION 11 TOXICOLOGICAL INFORMATION

##### ACUTE TOXICITY

Route of Exposure	Conclusion / Remarks
<b>Inhalation</b>	
Toxicity (Rat): LC50 > 5000 mg/m <sup>3</sup>	Minimally Toxic. Based on test data for structurally similar materials.
Irritation: No end point data.	Negligible hazard at ambient/normal handling temperatures. Based on assessment of the components.
<b>Ingestion</b>	
Toxicity (Rat): LD50 > 5000 mg/kg	Minimally Toxic. Based on test data for structurally similar materials.
<b>Skin</b>	
Toxicity (Rabbit): LD50 > 5000 mg/kg	Minimally Toxic. Based on test data for structurally similar materials.
Irritation (Rabbit): Data available.	Negligible irritation to skin at ambient temperatures. Based on test data for structurally similar materials.
<b>Eye</b>	
Irritation (Rabbit): Data available.	May cause mild, short-lasting discomfort to eyes. Based on test data for structurally similar materials.

##### CHRONIC/OTHER EFFECTS

###### Contains:

Base oil severely refined: Not carcinogenic in animal studies. Representative material passes IP-346, Modified Ames test, and/or other screening tests. Dermal and inhalation studies showed minimal effects; lung non-specific infiltration of immune cells, oil deposition and minimal granuloma formation. Not sensitizing in test animals.



Product Name: MOBIL VACTRA OIL NO. 2  
 Revision Date: 17 Oct 2008  
 Page 6 of 8

Additional information is available by request.

**The following ingredients are cited on the lists below:** None.

	--REGULATORY LISTS SEARCHED--		
1 = NTP CARC	3 = IARC 1	5 = IARC 2B	
2 = NTP SUS	4 = IARC 2A	6 = OSHA CARC	

## SECTION 12 ECOLOGICAL INFORMATION

The information given is based on data available for the material, the components of the material, and similar materials.

### ECOTOXICITY

Material -- Not expected to be harmful to aquatic organisms.

### MOBILITY

Base oil component -- Low solubility and floats and is expected to migrate from water to the land. Expected to partition to sediment and wastewater solids.

### PERSISTENCE AND DEGRADABILITY

#### Biodegradation:

Base oil component -- Expected to be inherently biodegradable

### BIOACCUMULATION POTENTIAL

Base oil component -- Has the potential to bioaccumulate, however metabolism or physical properties may reduce the bioconcentration or limit bioavailability.

## SECTION 13 DISPOSAL CONSIDERATIONS

Disposal recommendations based on material as supplied. Disposal must be in accordance with current applicable laws and regulations, and material characteristics at time of disposal.

### DISPOSAL RECOMMENDATIONS

Product is suitable for burning in an enclosed controlled burner for fuel value or disposal by supervised incineration at very high temperatures to prevent formation of undesirable combustion products.

### REGULATORY DISPOSAL INFORMATION

RCRA Information: The unused product, in our opinion, is not specifically listed by the EPA as a hazardous waste (40 CFR, Part 261D), nor is it formulated to contain materials which are listed as hazardous waste. It does not exhibit the hazardous characteristics of ignitability, corrosivity or reactivity and is not formulated with contaminants as determined by the Toxicity Characteristic Leaching Procedure (TCLP). However, used product may be regulated.

**Empty Container Warning** Empty Container Warning (where applicable): Empty containers may contain residue and can be dangerous. Do not attempt to refill or clean containers without proper instructions. Empty drums should be





Product Name: MOBIL VACTRA OIL NO. 2  
 Revision Date: 17Oct2008  
 Page 7 of 8

completely drained and safely stored until appropriately reconditioned or disposed. Empty containers should be taken for recycling, recovery, or disposal through suitably qualified or licensed contractor and in accordance with governmental regulations. DO NOT PRESSURISE, CUT, WELD, BRAZE, SOLDER, DRILL, GRIND, OR EXPOSE SUCH CONTAINERS TO HEAT, FLAME, SPARKS, STATIC ELECTRICITY, OR OTHER SOURCES OF IGNITION. THEY MAY EXPLODE AND CAUSE INJURY OR DEATH.

<b>SECTION 14</b>	<b>TRANSPORT INFORMATION</b>
-------------------	------------------------------

**LAND (DOT)** : Not Regulated for Land Transport

**LAND (TDG)** : Not Regulated for Land Transport

**SEA (IMDG)** : Not Regulated for Sea Transport according to IMDG-Code

**AIR (IATA)** : Not Regulated for Air Transport

<b>SECTION 15</b>	<b>REGULATORY INFORMATION</b>
-------------------	-------------------------------

**OSHA HAZARD COMMUNICATION STANDARD:** When used for its intended purposes, this material is not classified as hazardous in accordance with OSHA 29 CFR 1910.1200.

**NATIONAL CHEMICAL INVENTORY LISTING:** AICS, IECSC, DSL, EINECS, ENCS, KECI, PICCS, TSCA

**EPCRA:** This material contains no extremely hazardous substances.

**SARA (311/312) REPORTABLE HAZARD CATEGORIES:** None.

**SARA (313) TOXIC RELEASE INVENTORY:** This material contains no chemicals subject to the supplier notification requirements of the SARA 313 Toxic Release Program.

**The Following Ingredients are Cited on the Lists Below:** None.

--REGULATORY LISTS SEARCHED--

1 = ACGIH ALL	6 = TSCA 5a2	11 = CA P65 REPRO	16 = MN RTK
2 = ACGIH A1	7 = TSCA 5e	12 = CA RTK	17 = NJ RTK
3 = ACGIH A2	8 = TSCA 6	13 = IL RTK	18 = PA RTK
4 = OSHA Z	9 = TSCA 12b	14 = LA RTK	19 = RI RTK
5 = TSCA 4	10 = CA P65 CARC	15 = MI 293	

Code key: CARC=Carcinogen; REPRO=Reproductive

<b>SECTION 16</b>	<b>OTHER INFORMATION</b>
-------------------	--------------------------

N/D = Not determined, N/A = Not applicable

**THIS SAFETY DATA SHEET CONTAINS THE FOLLOWING REVISIONS:**



Product Name: MOBIL VACTRA OIL NO. 2  
Revision Date: 17Oct2008  
Page 8 of 8

---

No revision information is available.

---

The information and recommendations contained herein are, to the best of ExxonMobil's knowledge and belief, accurate and reliable as of the date issued. You can contact ExxonMobil to insure that this document is the most current available from ExxonMobil. The information and recommendations are offered for the user's consideration and examination. It is the user's responsibility to satisfy itself that the product is suitable for the intended use. If buyer repackages this product, it is the user's responsibility to insure proper health, safety and other necessary information is included with and/or on the container. Appropriate warnings and safe-handling procedures should be provided to handlers and users. Alteration of this document is strictly prohibited. Except to the extent required by law, republication or retransmission of this document, in whole or in part, is not permitted. The term, "ExxonMobil" is used for convenience, and may include any one or more of ExxonMobil Chemical Company, Exxon Mobil Corporation, or any affiliates in which they directly or indirectly hold any interest.

---

Internal Use Only

MHC: 0B,0B,0,0,0,0

PPEC: A

DGN: 2007221XUS (1014962)

---

Copyright 2002 Exxon Mobil Corporation, All rights reserved

# Product Information

A PRODUCT OF THE VALVOLINE COMPANY A DIVISION OF ASHLAND INC.



## VALVOLINE HIGH PERFORMANCE GEAR OIL

Valvoline High Performance Gear Oils are superior sulfur-phosphorus, extreme pressure gear lubricants formulated with premium quality base stocks to meet the demands for excellent performance. It is designed to provide excellent load carrying capacity, extreme pressure properties, anti-foam performance, demulsibility, corrosion protection, thermal stability protection, and service fill limited slip capability. These products are recommended for conventional rear axles, limited slip rear axles, and transmissions requiring EP gear lubes under high speed, high load, high torque, and high horsepower conditions. Valvoline High Performance Gear Oils meet or exceed API Services GL-5 and GL-4\*. The inclusion of Limited Slip Friction Modifier in this product makes it unnecessary to add additional friction modifier (Ford M2C118A, Chrysler MS-5630, or GM1052358) in most vehicles.

### The Valvoline High Performance Gear Oils Advantages:

- **Thermal Protection:** Provides outstanding thermal stability for cleanliness and longer service life.
- **Wear Protection:** Contains additives to assist in protecting gear teeth against pitting, spalling, and scouring.
- **Reduces Chattering:** Contains special additives to reduce chattering in limited-slip differentials.
- **Corrosion Protection:** Protects parts from rust and corrosion.

Approvals/Performance Levels			
API GL-4 *	75W-90	80W-90	85W-140
API GL-5	75W-90	80W-90	85W-140
Test	75W-90	80W-90	85W-140
Vis @ 100°C (cSt)	15.47	14.4	28.1
Vis @ 40°C (cSt)	99.0	145.9	394
Viscosity Index	166	96	98
Spec Gravity @ 60F	0.862	0.895	0.904
Density (lbs/gal)	7.19	7.47	7.53
Brookfield Vis., cP	106,000(-40C)	108,000(-26C)	120,000(-12C)
Pour Point, C	-45	-30	-15
Phosphorus, wt%	0.066	0.066	0.066

\*In synchronized manual transmission applications use:

- Valvoline Professional Series Manual Transmission Fluid or
- Valvoline Synchronmesh Manual Transmission Fluid (available September 2012)

Effective Date: 05/21/2012

Replaces: 01/27/2012

ZGZ

Doc # Rev 5



# Product Information

A PRODUCT OF THE VALVOLINE COMPANY A DIVISION OF ASHLAND INC.

## VALVOLINE SYNPOWER FULL SYNTHETIC GEAR OIL W/LIMITED SLIP

**Valvoline SynPower Gear Oil** is a superior sulfur-phosphorus extreme pressure gear lubricant formulated with synthetic basestocks and additives to provide excellent performance. It is designed to provide excellent extreme pressure protection, load carrying capacity, anti-foam performance, corrosion protection, and thermal stability protection. It is recommended for conventional and high performance applications. **Valvoline SynPower Gear Oil** is recommended for use in axle applications requiring factory-fill or drain-and-fill levels of limited slip performance.

**Valvoline SynPower Gear Oil** is recommended for use in axle applications requiring factory-fill or drain-and-fill levels of limited slip performance. Valvoline SynPower 75W-140 is also recommended for use where Ford **M2C-192A**, GM **12346140**, Chrysler **MS-8985**, or **GL-5** SAE 75W-140 gear oil is specified. The addition of a supplemental friction modifier (Ford M2C-118-A, Chrysler MS-5630, or GM 1052358) **is not** required.

### Valvoline SynPower Gear Oil Advantages:

- **Thermal Protection:** Provides outstanding thermal stability for cleanliness and longer service life.
- **Corrosion Protection:** Protects parts from rust and corrosion.
- **Reduces Chattering:** Contains special additives to reduce chattering in limited-slip differentials.
- **Wear Protection:** Contains additives to assist in protecting gear teeth.
- **Flow Properties:** Provides excellent low temperature protection.

Approvals/Performance Levels	Viscosity Grade/Other	
API MT-1	75W-90	
API GL-5	75W-90	75W-140
API GL-4*	75W-90	75W-140
MIL-PRF-2105E	75W-90	
SAE J2360	75W-90	
Mack GO-J	75W-90	

Test	75W-90	75W-140
Vis @ 100°C (cSt)	15.6	25.8
Vis @ 40°C (cSt)	100	171
Viscosity Index	150	183
Spec Gravity @ 60°F	0.865	0.861
Density (lbs/gal)	7.22	7.18
Flash COC (°C)	231	173
Pour Point (°C)	-48	-48
Phosphorus, wt. %	0.21	0.19
Sulfur, wt. %	2.3	2.3
Boron, wt. %	0.03	0.03

\*In synchronized manual transmission applications use:

- Valvoline Professional Series Manual Transmission Fluid or
- Valvoline Synchronmesh Manual Transmission Fluid (available September 2012)

This information only applies to products manufactured in the following location(s):

Effective Date:	Replaces:	Author's Initials:	Pages	Code
05-21-12	01-23-12	ZGZ		Rev 005

KYODO YUSHI  
MATERIAL SAFETY DATA SHEET

PAGE 1

MSDS No. : 07-543  
PRODUCT NAME : MOLYWHITE RE No.00

DATE PREPARED:2009/ 4 / 1

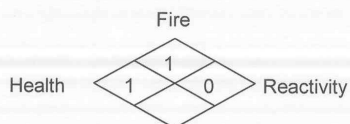

NFPA HAZARD RATING  
4 -- Extreme  
3 -- Height  
2 -- Moderate  
1 -- Slight  
0 -- Insignificant

### 1 CHEMICAL PRODUCT AND COMPANY IDENTIFICATION

PRODUCT NAME : MOLYWHITE RE No.00  
PRODUCT CODE : 07543

COMPANY NAME : KYODO YUSHI CO., LTD.  
2-2-30, TSUJIDO KANDAI, FUJISAWA-SHI, KANAGAWA, JAPAN

EMERGENCY TELEPHONE NUMBER : +81 - 466 - 33 - 3157

### 2 COMPOSITION / INFORMATION ON INGREDIENTS

CHEMICAL FAMILY : Lubricating Grease.

FORMULA : not applicable

COMPONENTS :

NAME	CONTENTS (%)
Base oil (Refined mineral oil, synthetic hydrocarbon oil)	85 - 95
Thickener (Lithium soap)	<10
EP additives (Containing molybdenum, zinc compound)	<5
Oxidation inhibitor (2,6-di-t-butyl-p-cresol)	<5
Additives (Containing barium compound)	<5

HAZARDOUS INGREDIENTS

NAME	CAS No.	CONTENTS (%)
Molybdenum compound	68412-26-0	1 - 3
2,6-di-t-butyl-p-cresol	128-37-0	1 - 3

See Section 8 for exposure limits (if applicable)

### 3 HAZARDOUS IDENTIFICATION

CLASS NAME OF HAZARDOUS CHEMICALS FOR SDS IN JAPAN Not applicable

- PHYSICAL AND CHEMICAL HAZARDS : Not applicable
- ADVERSE HUMAN HEALTH EFFECTS :Prolonged and repeated contact may cause skin irritation.
- ENVIRONMENTAL EFFECTS : No data available.

KYODO YUSHI  
MATERIAL SAFETY DATA SHEET

PAGE 2

MSDS No. : 07-543

DATE PREPARED:2009/ 4 / 1

PRODUCT NAME : MOLYWHITE RE No.00

---

**4 FIRST AID MEASURES**

---

**EYES** : Immediately flush with water for at least 15 minutes. Get medical attention.

**SKIN** : Remove excess with cloth or paper and wash area thoroughly with soap and water.

**INGESTION** : Consult a physician. Do not induce vomiting.

**INHALATION** : Keep the victim warm and quiet. Remove the victim from the contamination  
Immediately to fresh air.

**NOTE TO PHYSICIANS** : Supportive care. Treatment based on judgment of the physician in  
response to reactions of the patient.

---

**5 FIRE FIGHTING MEASURES**

---

**FLAMMABLE PROPERTIES :**

- FLASH POINT: 190 °C                      METHOD : Seta Flash Method
- FLAMMABLE LIMITS: LFL: N/A              UFL: N/A
- AUTOIGNITION TEMPERATURE: no data available
- HAZARDOUS DECOMPOSITION PRODUCTS : Thermal decomposition and combustion may  
produce carbon monoxide and/or carbon dioxide.

\* N/A : Not applicable.

**EXTINGUISH MEDIA** : Dry chemical, Water fog, CO<sub>2</sub>, Foam, Sand/Earth

**FIRE FIGHTING INSTRUCTIONS** : Dense smoke. Fire fighter wear an approved self-contained  
breathing apparatus. Do not use water except fog.

---

**6 ACCIDENTAL RELEASE MEASURES**

---

**PROCEDURE FOR CLEAN-UP** : Transfer bulk of mixture into another container. Absorb residue  
with an inert material such as earth, sand and vermiculite.  
Sweep up and dispose solid waste in accordance with local, state and federal regulations.

**WASTE DISPOSAL** : Dispose of in accordance with all applicable federal, state and local  
regulations.

---

**7 HANDLING AND STORAGE**

---

**HANDLING** : Contact with eye may cause irritation. Use protective glasses or other devices to avoid  
contact with eyes. Contact with skin may cause irritation. Use protective gloves to avoid skin  
contact.

Do not swallow. (Eating product cause diarrhea and vomiting.)

Wear gloves to avoid injury on hands at opening the container.

Keep out reach of children.

**STORAGE** : Keep container closed until ready for use. Storage away from fire source or  
sunlight and in cool dry area.



KYODO YUSHI  
MATERIAL SAFETY DATA SHEET

PAGE 3

MSDS No. : 07-543

DATE PREPARED:2009/ 4 / 1

PRODUCT NAME : MOLYWHITE RE No.00

**8 EXPOSURE CONTROLS/PERSONAL PROTECTION****CONTROL PARAMETERS :**

Oil mist, mineral: ACGIH TLV (2007): TWA 5mg/m<sup>3</sup>  
 Molybdenum compound: ACGIH TLV (2007): TWA as Mo 10mg/m<sup>3</sup>  
 2,6-di-t-butyl-p-cresol ACGIH TLV (2007): TWA 2mg/m<sup>3</sup>

**ENGINEERING MEASURES :** none**PERSONAL PROTECTIVE EQUIPMENT :**

- RESPIRATORY PROTECTION : Wear a gas mask (for organic gas), if necessary.
- EYE PROTECTION : Chemical safety goggles and if handled hot, full face shield.
- HAND AND BODY PROTECTION : Protective gloves, rubber or plastic oil resistant.
- OTHER PROTECTIVE EQUIPMENT : none

**9 PHYSICAL AND CHEMICAL PROPERTIES**

• APPEARANCE :	Yellow paste	• ODOR :	Slight odor.
• VAPOR PRESSURE :	N/A	• VAPOR DENSITY(AIR=1) :	N/A
• SPECIFIC GRAVITY(H <sub>2</sub> O=1):	0.87	• EVAPORATION RATE	Slower
• SOLUBILITY IN WATER :	Negligible	(n-Butyl Acetate=1)	
• SOLUBILITY IN ---- :	N/A	• FREEZING POINT :	N/A
• PH :	N/A	• VISCOSITY :	N/A
• BOILING POINT :	N/A	• MELTING POINT(Dropping Point) :	193 °C
• MELTING POINT(Dropping Point) :	193 °C		

\* N/A : Not applicable.

**10 STABILITY AND REACTIVITY**

- STABILITY : (CONDITION TO AVOID) Product is stable under normal condition. Avoid over heating.
- INCOMPATIBILITY : ( SPECIFIC MATERIALS TO AVOID) Strong oxidizers such as hydrogen peroxide, bromine, and chromic acid.
- HAZARDOUS DECOMPOSITION PRODUCTS : Oxides of lithium, nitrogen, sulfur, zinc, phosphorus, barium and molybdenum.
- HAZARDOUS POLYMERIZATION : none
- REACTIVITY WITH WATER : none

**11 TOXICOLOGICAL INFORMATION**

- CORROSIVE AND IRRITANT PROPERTIES : No data available
- ALLERGENIC AND SENSITIZING EFFECTS :No data available
- ACUTE TOXICITY : Refined mineral oil LD50 Acute oral 5<g/kg(rat)
- SUB-CHRONIC TOXICITY : No data available
- CHRONIC TOXICITY : Prolonged and repeated skin contact may cause irritation.
- CARCINOGENIC EFFECT : Not listed IARC,NTP,ACGIH.
- MUTAGENIC EFFECTS : No data available
- EFFECTS ON THE REPRODUCTIVE SYSTEM : No data available
- TERATOGENIC EFFECTS : No data available



KYODO YUSHI  
MATERIAL SAFETY DATA SHEET

PAGE 4

MSDS No. : 07-543

DATE PREPARED:2009/ 4 / 1

PRODUCT NAME : MOLYWHITE RE No.00

---

**1 2 ECOLOGICAL INFORMATION**

---

- BIODEGRABILITY : No data available
- BIOACCUMULATION : No data available
- FISH TOXICITY : No data available

---

**1 3 DISPOSAL CONSIDERATION**

---

WASTE DISPOSAL METHOD : Incinerate in accordance with applicable regulation.

ATTENTION : Do not use pressure to empty this container. When empty, container may have vapor or product residue. Do not cut, puncture or weld on near the drum.

---

**1 4 TRANSPORT INFORMATION**

---

DOT : Not applicable  
UN No. : Not applicable  
FIRE SERVICE LAW (JAPAN) : Not applicable  
LAND(RID/ADR): Not regulated for rail/road transport  
SEA(IMO/IMDG): Not regulated for sea transport  
AIR(ICA/O/IATA): Not regulated for air transport

---

**1 5 REGULATORY INFORMATION**

---

Regulatory information with regard to this product in your country or your region should be examined by your own responsibility.

US TSCA (Toxic Substances Control Act):

All components of this product are listed on the TSCA inventory of Chemical Substances.

US OSHA (Occupational Safety and Health Act):

This product is hazardous according to the OSHA Hazard Communication Standard, 29 CFR 1910.1200, since this product contains OSHA Hazardous Substances; Molybdenum compound, 2,6-di-t-butyl-p-cresol.

US CERCLA (Comprehensive Environmental Release, Compensation & Liability Act):

Zinc compounds (0.1 – 0.5%) no RQ is assigned to this generic or broad class.

US SARA (Superfund Amendment & Reauthorization Act ) Title III:

This product contains no Extremely Hazardous Substances.

SARA Hazard Categories (311/312): None

SARA Toxic Release Inventory (TRI) (313): Zinc compounds (0.1 – 0.5%)

Barium compounds (0.3 – 0.7%)

KYODO YUSHI  
MATERIAL SAFETY DATA SHEET

PAGE 5

MSDS No. : 07-543

DATE PREPARED:2009/ 4 / 1

PRODUCT NAME : MOLYWHITE RE No.00

---

**1 6 OTHER INFORMATION**

---

INFORMATION CONTACT : KYODO YUSHI CO., LTD.  
International Business Dept.  
2-2-30, TSUJIDO KANDAI, FUJISAWA-SHI, KANAGAWA, JAPAN  
Tel +81 - 466 - 33 - 3157

REFERENCE : CMA Interim Guideline for the Preparation of MSDS.  
Chapter 7 : MSDS Examples.  
ACGIH Threshold Limit Values for Chemical Substances in the Work Environment.  
(2007)

ORIGINAL DATE : 98/ 1 / 26,

REVISION DATE : 2009/ 4 / 1,

---

This MSDS is an addition and complementary document beside the technical data sheet.  
The information is based upon our knowledge about the product at the date of edition.  
Since we cannot anticipate or control the different conditions under which these information  
or our product may be used, we make no guarantee that recommendations will be adequate for all  
individuals and situations.